

MATERIALS AND FINISHES

BODY, JAMNUT BRASS  
PLATED GOLD

CENTER CONTACT BRASS  
PLATED GOLD

LOCKWASHER PHOSPHOR BRONZE  
PLATED GOLD

INSULATOR TEFLON

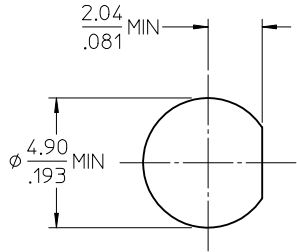
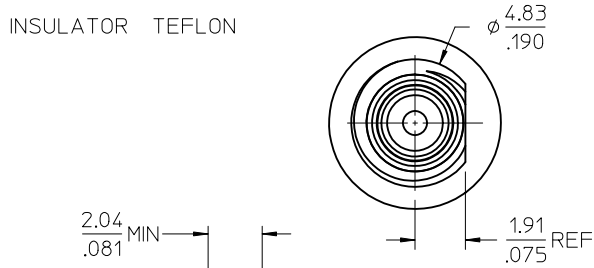
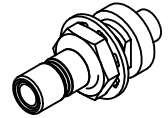

RECOMMENDED PANEL CUTOUT

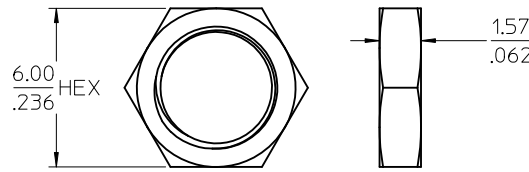
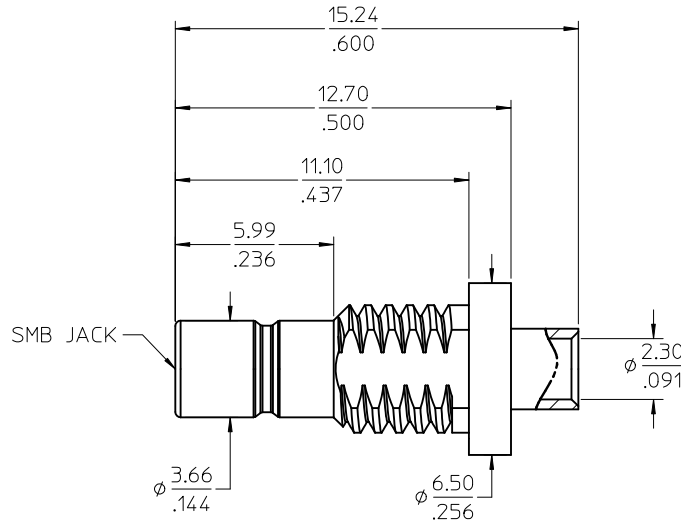

JAMNUT

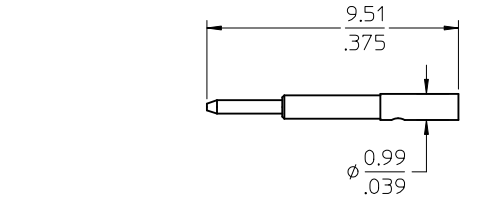

LOCKWASHER

73404-1481	ONE PER BAG
73404-1480	BULK
PART NO.	PACKAGING

MIL-STD-348A, FIG. 311.1	INTERFACE
SPECIFICATION	DESCRIPTION

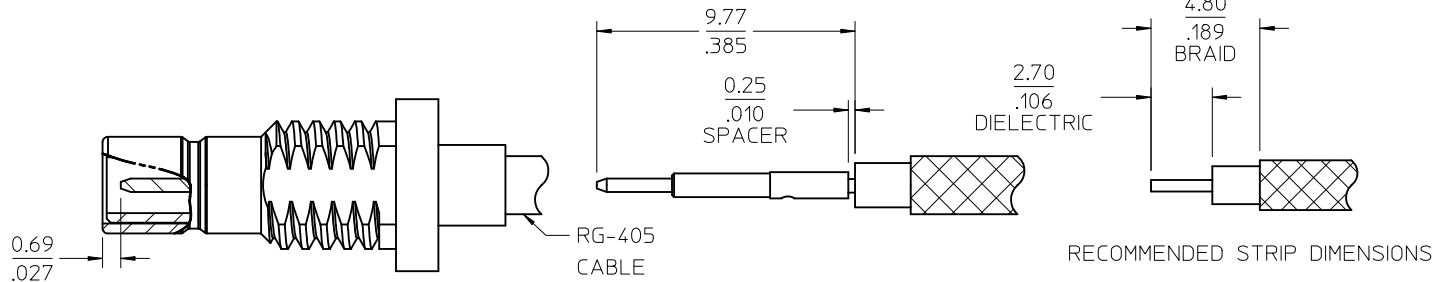

CHG: ADD -1481	DESCRIPTION
ADD CABLED VIEW	
EC NO: URF2011-0634	
DRWN: WIENER	
CHKD: SSS	
APPR: WIENER	
REV: A1	

QUALITY SYMBOLS	

GENERAL TOLERANCES (UNLESS SPECIFIED)	
4 PLACES ± --- ± ---	
3 PLACES ± --- ± ---	
2 PLACES ± --- ± ---	
1 PLACE ± --- ± ---	
ANGULAR ± 2 °	
DRAFT WHERE APPLICABLE MUST REMAIN WITHIN DIMENSIONS	

DIMENSION STYLE	MM/IN
DRAWN BY	DATE
CHECKED BY	DATE
APPROVED BY	DATE
MATERIAL NO.	
SEE TABLE	

SCALE	DESIGN UNITS	THIRD ANGLE PROJECTION
	METRIC	
TITLE		
SMB JACK, STR, BLKHD		
50 OHMS .086 (RG405)		
EWR-2175 SMB-JC		
MOLEX INCORPORATED		
DOCUMENT NO.		SHEET NO.
SD-73404-148		1 OF 1