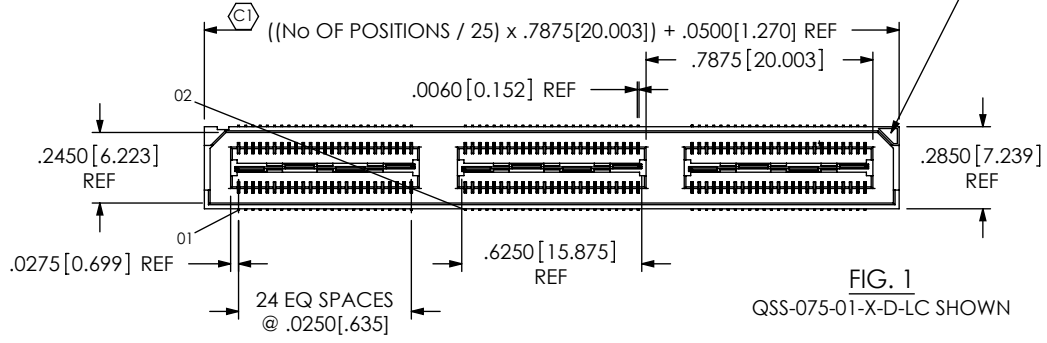

TABLE 1	
No OF POSITIONS	COPLANARITY (INCLUDING GND PLANE)
-025 THRU -050	.0040[.102]
-075 THRU -125	.0060[.152]

DO NOT SCALE FROM THIS PRINT

VOID CORE MAY OR MAY NOT BE PRESENT AT MOLDERS DISCRETION FOR THE CONTROL OF WARPAGE



QSS-XXX-XX-X-D-XXX

- No OF POSITIONS: -025, -050, -075, *-100, *-125
- LEAD STYLE: -01: .1430[3.632]
- PLATING SPECIFICATION (SEE TABLE 2)
- OPTION:
 - A: ALIGNMENT PINS (USE QSS-25-XX-D-XX-A) (SEE FIG. 2, SHEET 2)
 - LC: LOCKING CLIPS (USE LC-08-TM-01)
 - K: POLYIMIDE FILM PAD (USE K-DOT-.325-.450-.005) (SEE FIG. 2, SHEET 2)
 - TR: TAPE & REEL (75 POS MAX) (50 POS MAX FOR -GP)
 - GP: GUIDE POSTS (USE QSS-25-01-D-XX-X-GP) (SEE FIG. 3, SHEET 3)
 - LS2: LOCKING SCREW (USE QSS-25-01-D-XX-LS2) (SEE FIG. 4, SHEET 3) (FOR MATING WITH QTS-...-RA-..LS2)
- ROW SPECIFICATION: -D: DOUBLE (USE QSS-25-XX-D-XX)
- No OF BANKS

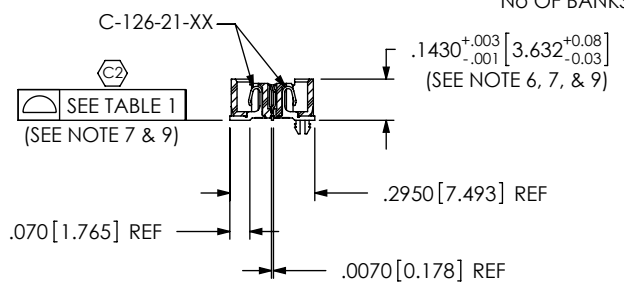
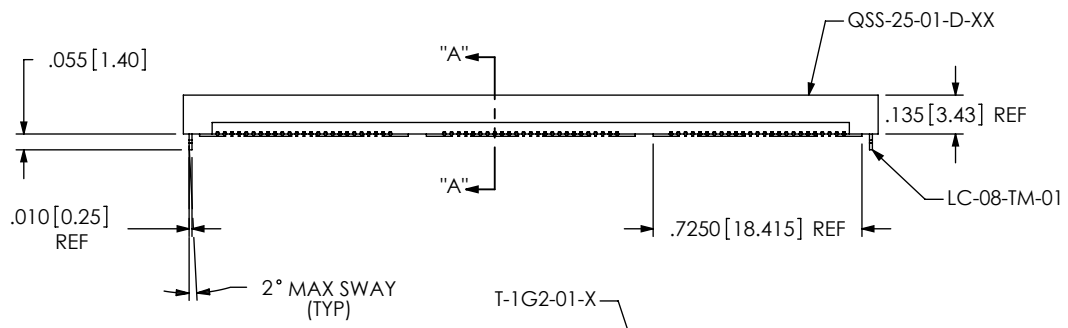

NOTES:

1. CONTACT RETENTION: 6 OZ MIN
2. GROUND PLANE RETENTION: 8 OZ MIN
3. © REPRESENTS A CRITICAL DIMENSION.
4. PARTS ARE MOLD TO POSITION.
5. NOTE WAS DELETED.
6. MAX VARIANCE OF .002[.05].
7. DIMENSION APPLIES TO CONTACTS AND GROUND PLANES, INDEPENDENT OF GROUND PLANES AND CONTACTS RESPECTIVELY.
8. -L PLATING CAN BE SUBSTITUTED FOR -F PLATING.
9. GROUND PLANE PRESS HEIGHT MUST BE .003[.08] LESS THAN THE MAX HEIGHT OR .001[.03] GREATER THAN THE MINIMUM HEIGHT OF THE TERMINALS.
10. FOR NEW APPLICATIONS REQUIRING THESE POSITIONS, PLEASE CONTACT SAMTEC INTERCONNECT PROCESSING GROUP.
11. FOR -100 AND -125 POSITIONS USE C-269-11-X, DO NOT SUB C-126-01-X.

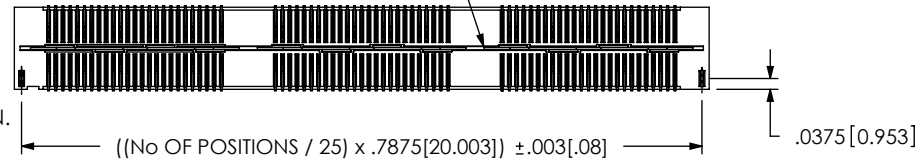

-LC: LOCKING CLIP OPTION SHOWN

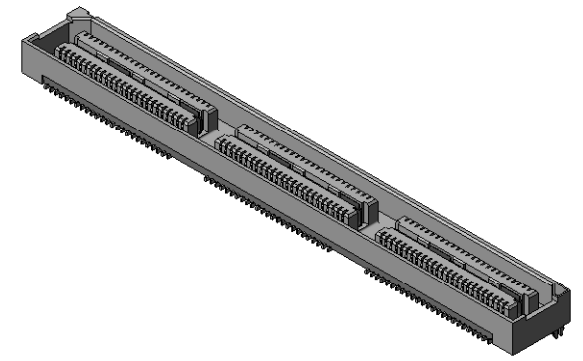



TABLE 2: PLATING SPECIFICATION						
OPTION	CONTACT		CONTACT CALLOUT	GROUND PLANE		GROUND PLANE CALLOUT
	CONTACT AREA	REMAINDER		CONTACT AREA	REMAINDER	
-F	.000003 GOLD	.000150 MIN MATTE TIN	C-126-21-F	.000003 GOLD	.000150 MIN MATTE TIN	T-1G2-01-F
-L	.000010 GOLD	.000150 MIN MATTE TIN	C-126-21-L	.000010 GOLD	.000150 MIN MATTE TIN	T-1G2-01-L
-H	.000030 GOLD	.000003 GOLD	C-126-21-H	.000010 GOLD	.000003 GOLD	T-1G2-01-G
-C	.000050 GOLD	.000150 MIN MATTE TIN	C-126-21-C	.000010 GOLD	.000150 MIN MATTE TIN	T-1G2-01-L

UNLESS OTHERWISE SPECIFIED, DIMENSIONS ARE IN INCHES[MM] TOLERANCES ARE: DECIMALS ANGLES .XX: ±.01[.3] 2° .XXX: ±.005[.13] .XXXX: ±.0020[.051]	PROPRIETARY NOTE THIS DOCUMENT CONTAINS INFORMATION CONFIDENTIAL AND PROPRIETARY TO SAMTEC, INC. AND SHALL NOT BE REPRODUCED OR TRANSFERRED TO OTHER DOCUMENTS OR DISCLOSED TO OTHERS OR USED FOR ANY PURPOSE OTHER THAN THAT WHICH IT WAS OBTAINED WITHOUT THE EXPRESSED WRITTEN CONSENT OF SAMTEC, INC.	 520 PARK EAST BLVD, NEW ALBANY, IN 47150 PHONE: 812-944-6733 FAX: 812-948-5047 e-Mail: info@SAMTEC.com code: 55322	
		MATERIAL: DO NOT SCALE DRAWING SHEET SCALE: 1.5:1 INSULATOR: LCP, COLOR: BLACK CONTACT: PHOS BRONZE GROUND PLANE: PHOS BRONZE	
DESCRIPTION: .635mm DOUBLE ROW HS SOCKET ASSEMBLY DWG. NO. QSS-XXX-XX-X-D-XXX		BY: DEAN P 6/28/1999 SHEET 1 OF 3	

-A: ALIGNMENT PIN OPTION SHOWN

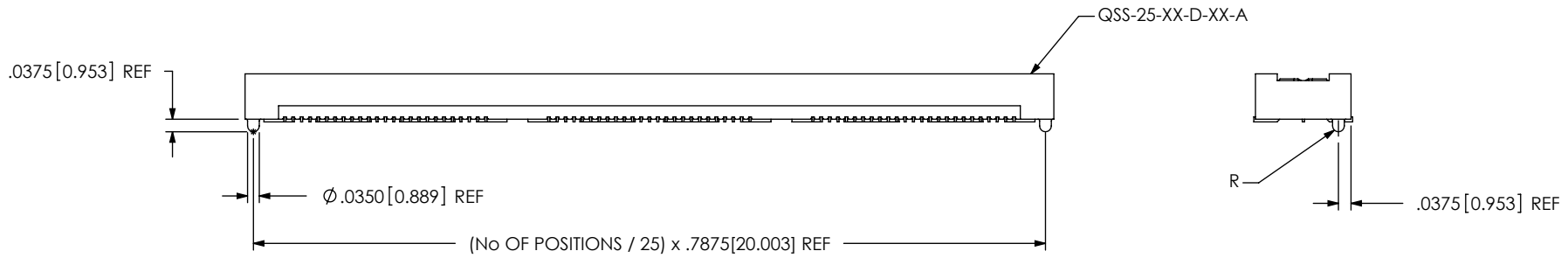
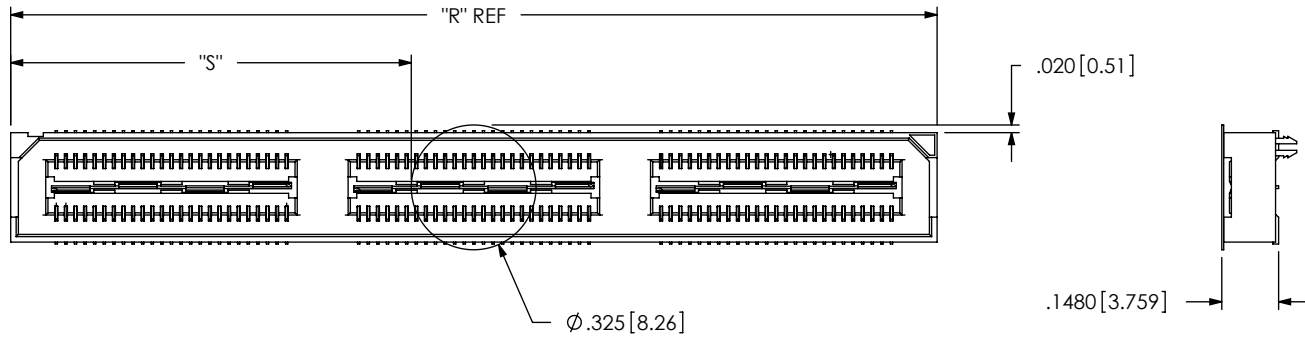

FIG. 2
-K: POLYIMIDE FILM PAD
(USE K-DOT-.325-.450-.005)



NOTE: "R" = ((No OF POSITIONS/25) x .7875 [20.003]) + .0500 [1.270] AS MEASURED
"S" = (("R" - .325 [8.26]) / 2) ± .020 [51]

<p>PROPRIETARY NOTE THIS DOCUMENT CONTAINS INFORMATION CONFIDENTIAL AND PROPRIETARY TO SAMTEC, INC. AND SHALL NOT BE REPRODUCED OR TRANSFERRED TO OTHER DOCUMENTS OR DISCLOSED TO OTHERS OR USED FOR ANY PURPOSE OTHER THAN THAT WHICH IT WAS OBTAINED WITHOUT THE EXPRESSED WRITTEN CONSENT OF SAMTEC, INC.</p> <p>DO NOT SCALE DRAWING</p> <p>SHEET SCALE: 2:1</p>		
	<p>520 PARK EAST BLVD, NEW ALBANY, IN 47150 PHONE: 812-944-6733 FAX: 812-948-5047 e-Mail: info@SAMTEC.com code: 55322</p>	
	<p>DESCRIPTION: .635mm DOUBLE ROW HS SOCKET ASSEMBLY</p>	
	<p>DWG. NO. QSS-XXX-XX-X-D-XXX</p>	
BY: DEAN P	6/28/1999	SHEET 2 OF 3

FIG. 3

-GP: GUIDE POSTS OPTION
 [DIFFERENT AS SHOWN, OTHERWISE SAME AS FIG. 1]

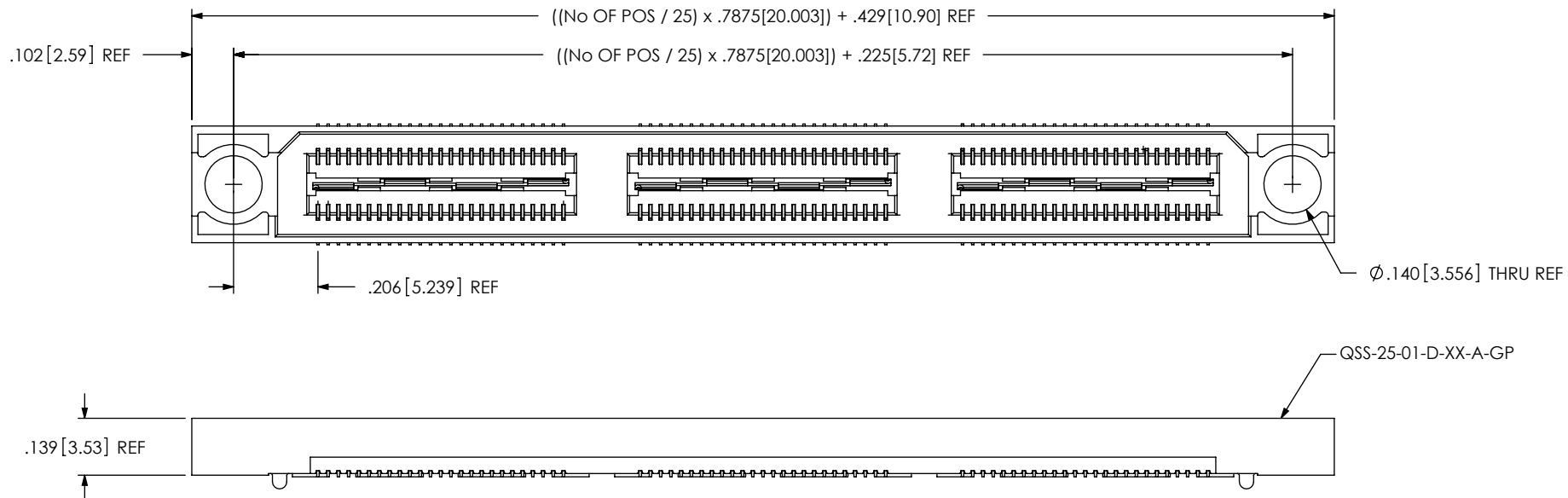
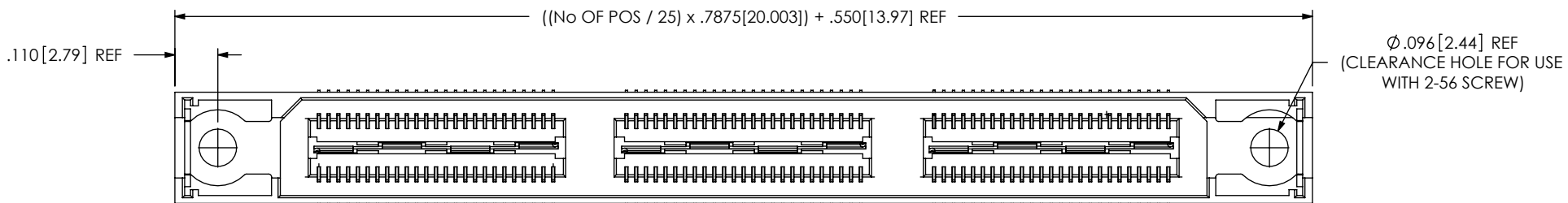

FIG. 4

-LS2: LOCKING SCREW OPTION
 [DIFFERENT AS SHOWN, OTHERWISE SAME AS FIG. 1]



PROPRIETARY NOTE

THIS DOCUMENT CONTAINS INFORMATION CONFIDENTIAL AND PROPRIETARY TO SAMTEC, INC. AND SHALL NOT BE REPRODUCED OR TRANSFERRED TO OTHER DOCUMENTS OR DISCLOSED TO OTHERS OR USED FOR ANY PURPOSE OTHER THAN THAT WHICH IT WAS OBTAINED WITHOUT THE EXPRESSED WRITTEN CONSENT OF SAMTEC, INC.

DO NOT SCALE DRAWING

SHEET SCALE: 2.5:1

samtec

520 PARK EAST BLVD, NEW ALBANY, IN 47150
 PHONE: 812-944-6733 FAX: 812-948-5047
 e-Mail: info@SAMTEC.com code: 55322

DESCRIPTION:
 .635mm DOUBLE ROW HS SOCKET ASSEMBLY

DWG. NO. QSS-XXX-XX-X-D-XXX

BY: DEAN P 6/28/1999 SHEET 3 OF 3