

Alle Rechte vorbehalten/ All rights reserved

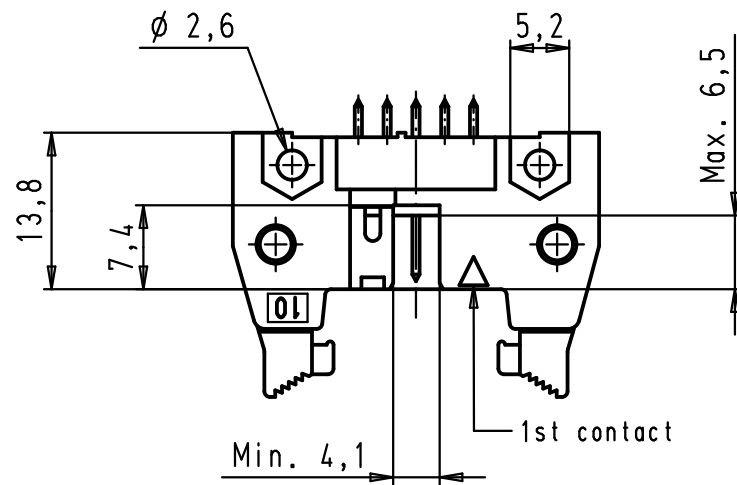

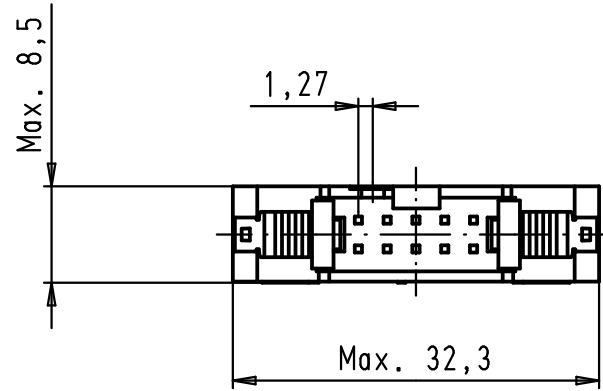

PCB layout, component side

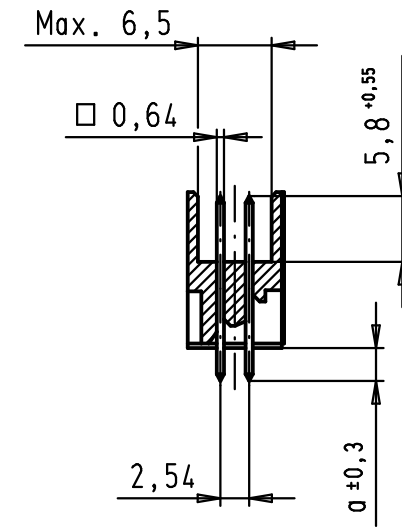
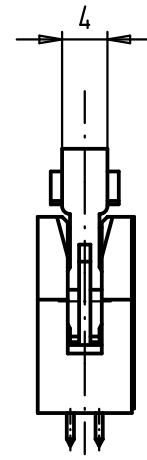
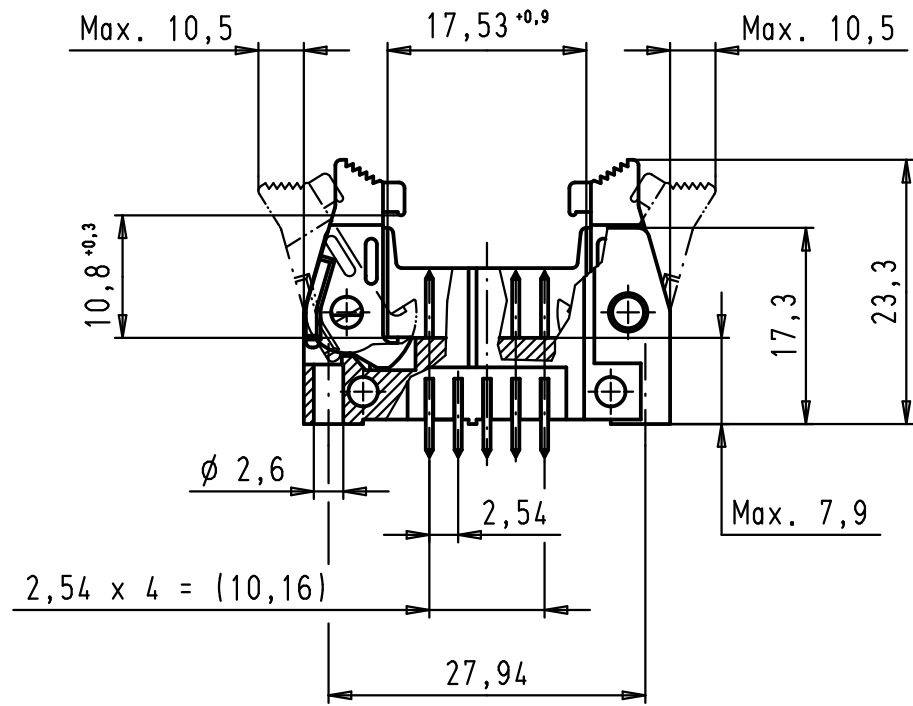
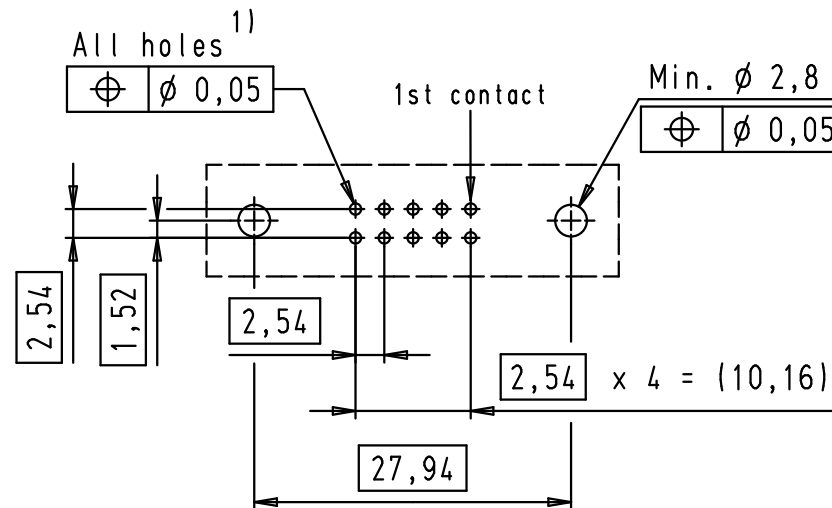

1) Solder pins for PCB connections
 $\phi 1 \pm 0,1$ according to IEC 60 326-3

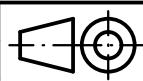
09 18 510 7912	3	4,5
09 18 510 6912	2	4,5
09 18 510 5912	0,76 $\mu\text{m Au}$	4,5
09 18 510 7914	3	2,9
09 18 510 6914	2	2,9
09 18 510 5914	0,76 $\mu\text{m Au}$	2,9
Part number	Performance level	a

				Det.	Name	 All Dim. in mm Orig. Size DIN A 3	SEK 18 Male Connector Standard 10 poles Straight solder pins Short locking levers	Maßstab/ Scale 1,5:1
				Detail.	01/12/99 JB			
				Insp.				
34900	29/01/08	LP		Stand.				
27931	15/06/00	JB						
26554	01/12/99	JB						
Mod.	Det.	Name	HARTING EURL F-95972 Paris				TB 09 18 510 X91X	Blatt/ Page 1 / 2