

No.	Changes and/or Note No.	Date	Intr.	No.	Changes and/or Note No.	Date	Intr.

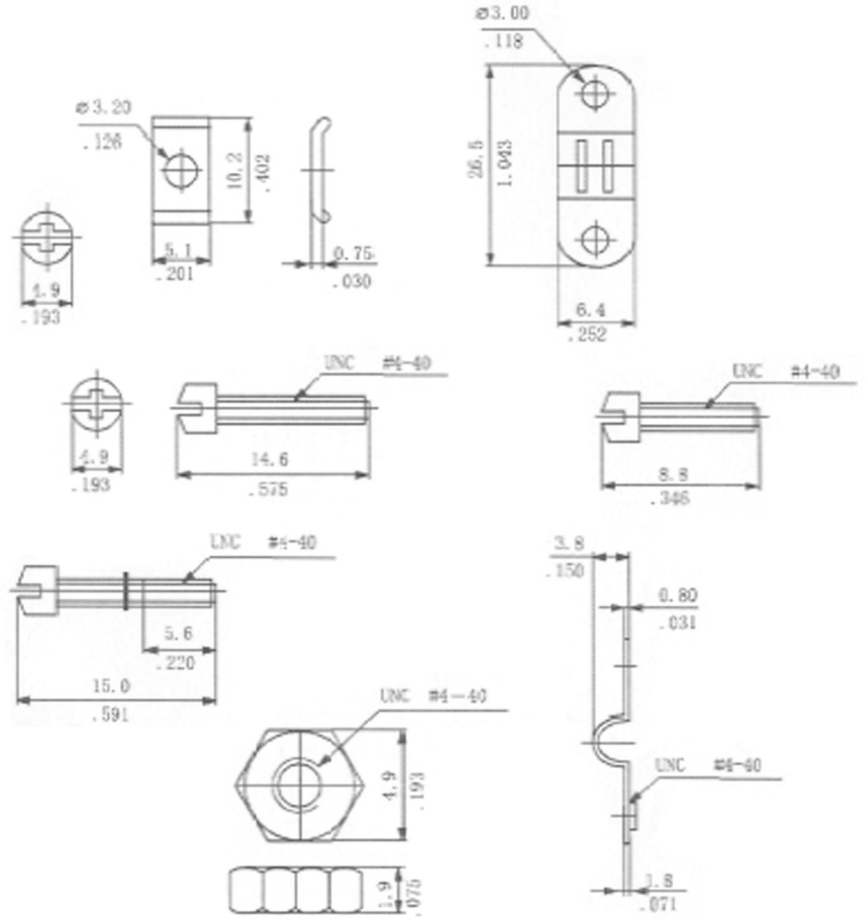
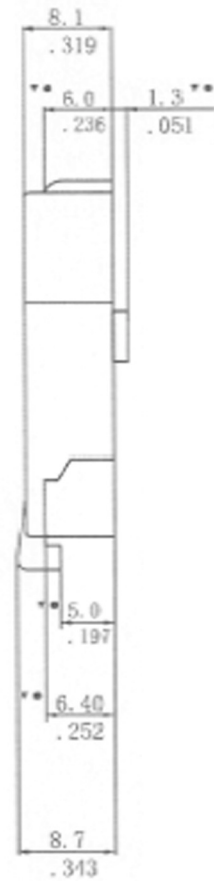
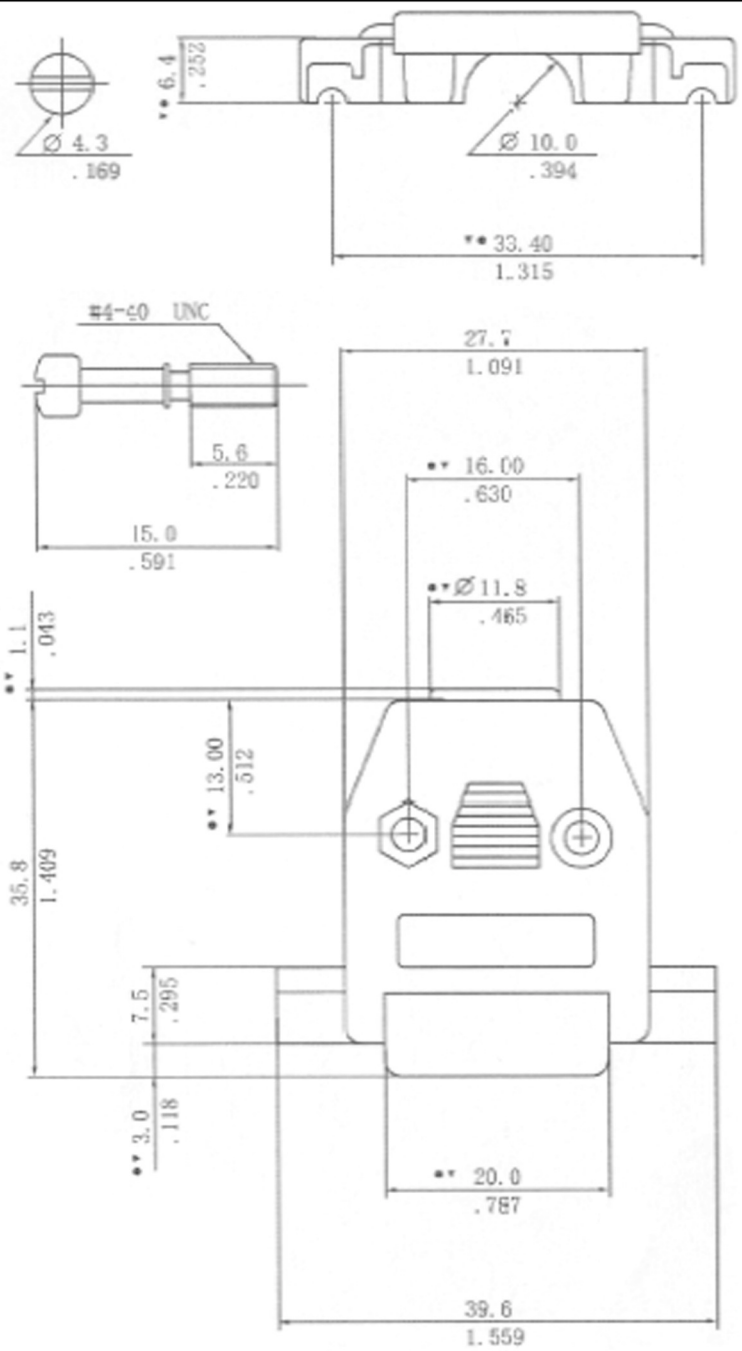

DATE	02/04/08	DRAWN	AS	SCALE	MATERIAL TYPE
P/N:2360-0102-02,9WAYS,BK		APPROVED			REPLACES
P/N:2360-0102-12,9WAYS,LG					
		CCOV-15-SC-BLACK CCOV-15-SC-LGREY			
DRAWING No					