

No.	Changes and/or Note No.	Date	Intr.	No.	Changes and/or Note No.	Date	Intr.

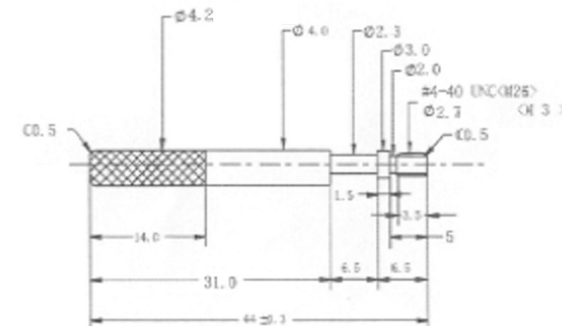
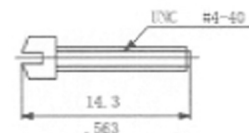
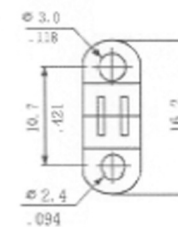
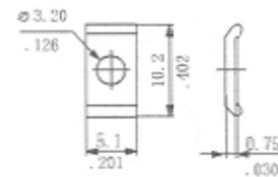
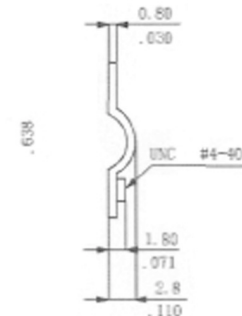
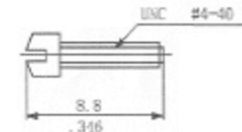
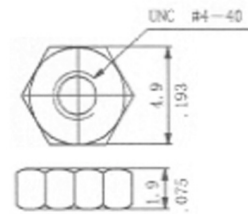
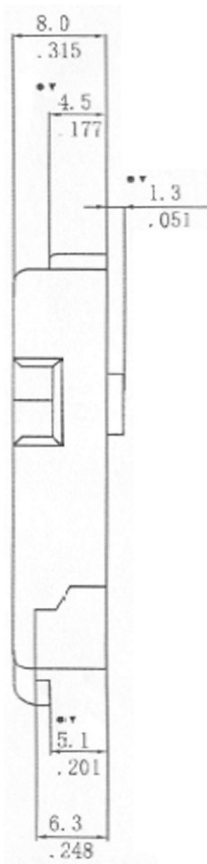
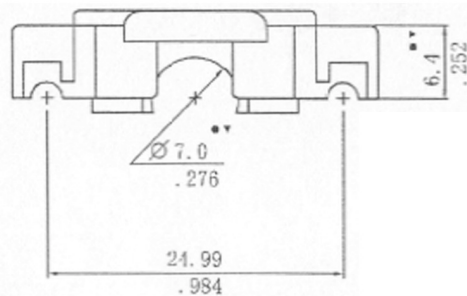
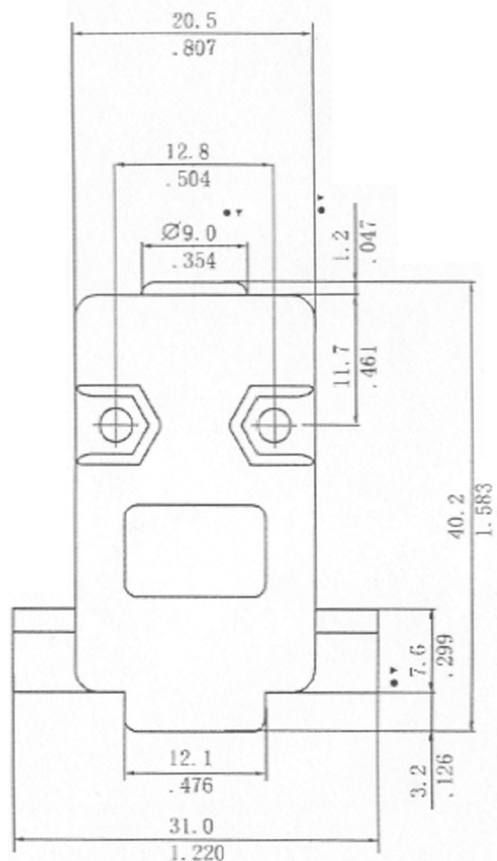

DATE 02/04/08	DRAWN AS	SCALE	MATERIAL TYPE
P/N:2360-0102-21,9WAYS,BK P/N:2360-0102-31,9WAYS,LG	APPROVED		REPLACES
			CCOV09-SCL-BLACK CCOV09-SCL-LIGHT GREY
			DRAWING No