

“Schutzvermerk nach DIN ISO 16016 beachten” “Please pay attention to copyright note DIN ISO 16016”

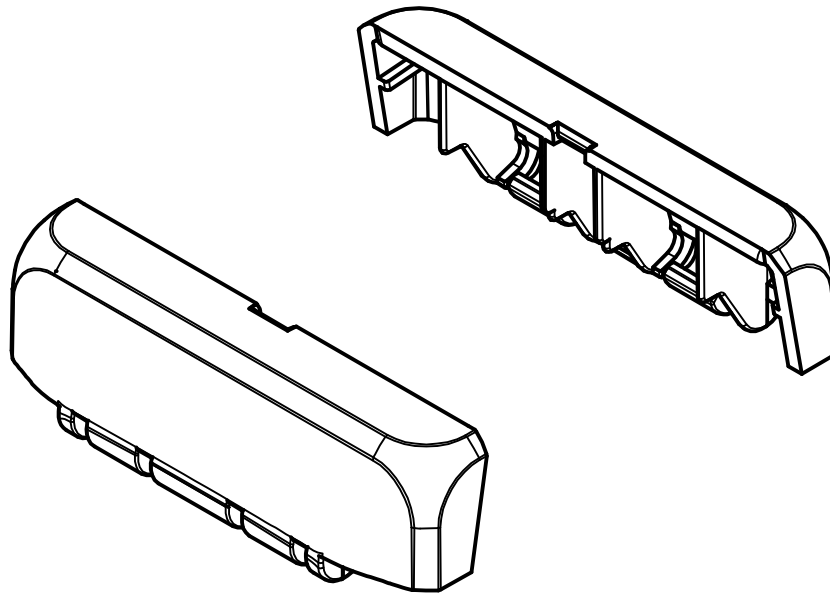

B SC 08 Montagerichtung
B SC 08 mounting direction

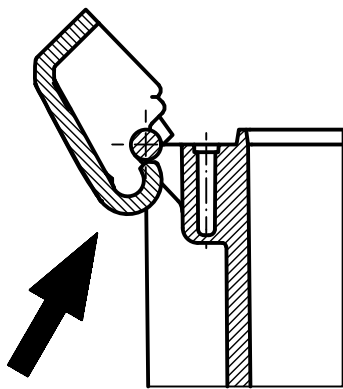

B SC 08 montiert
B SC 08 mounted

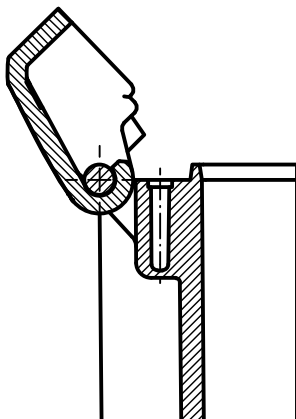

Maßstab/
Scale: 1:1

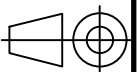

Zeichnungs-Nr. / Drawing-No.:
4K 5390.041.01

Artikel / Article:
BOCUBE
B SC 08
Katalogzg./Catalogue draw.

Ä.Nr/
Alt.No:

Datum/
Date:

DISK: 2503386.idw
Datum/Date: 11.07.2012 KH



BOPLA

A Phoenix Mecano Company