

| ITEM | Q'TY | PART NUMBER | PART DESCRIPTION |
|------|------|-------------|---|
| 1 | 1 | MPC5 | Chrome Panel Mount Holder, 5mm |
| 2 | 1 | 5XX-F | T-1¼ (5mm) Flanged LED, See Following Pages |

| REV. | DESCRIPTION | DATE | APPROVED |
|------|---------------------------------|----------|----------|
| A | Engineering Release. | 03/02/05 | M. C. |
| B | Corrected MPC5 Holder Dimension | 09/06/05 | M. C. |
| C | Corrected MPC5 Holder Dimension | 11/29/05 | M. C. |
| D | Updated MPC5 Holder Dimension | 09/15/06 | M. C. |
| E | Corrected LED Lead Polarity | 02/01/07 | M. C. |
| F | Updated LED offering | 05/03/12 | T. Y. |
| G | Corrected typo on page 4 | 07/16/12 | T. Y. |

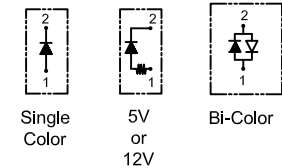
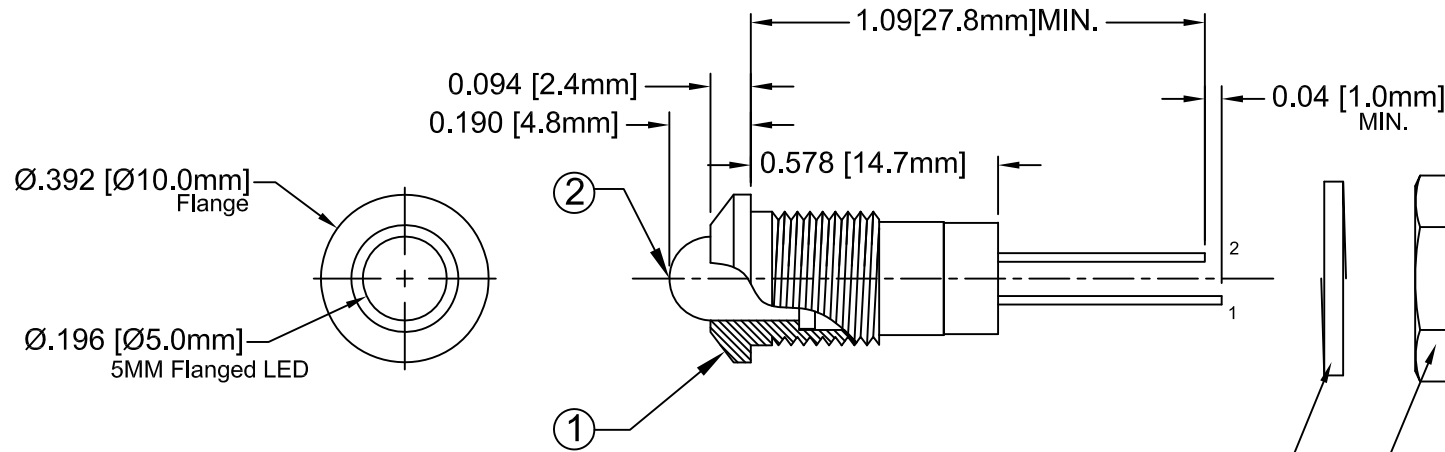

| BI-COLOR POLARITY | | |
|-------------------|-------------|-------------|
| LED P/N | (1) Cathode | (2) Cathode |
| 5BC | Green | Red |
| 5BC-Y/G | Green | Yellow |
| 5BC-R/Y | Yellow | Red |
| 5BC-A/G | Green | Amber |

M8 Spring Lock Washer
M8X.75 Nut, Stainless Steel

(Mounting Hardware included, packed separately)

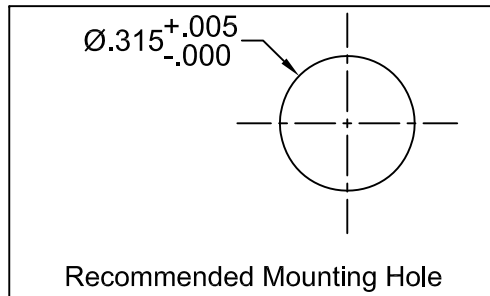

ABSOLUTE MAXIMUM RATINGS (Ta = 25°C)

REVERSE VOLTAGE _____ 5V
 REVERSE CURRENT (VR=5V) _____ 100µA
 OPERATING TEMPERATURE RANGE _____ -40°C ~ 85°C
 STORAGE TEMPERATURE _____ -40°C ~ 100°C
 LEAD SOLDERING TEMPERATURE (1/16" FROM BODY) _____ 260°C for 5 Seconds

| STANDARD TOLERANCE (UNLESS OTHERWISE SPECIFIED) | |  4 THOMAS, IRVINE, CA. 92618 TEL: (949) 951-8808 FAX: (949) 951-3974 |
|---|--------------------------|---|
| DECIMALS | ANGULAR | |
| .X ± .1 | X° ± 1° | TITLE: STD METAL PANEL MOUNT INDICATORS PART NO: MPC5XX REVISION: G |
| .XX ± .02 | | |
| .XXX ± .010 | | |
| DESIGNED: David Green | DATE: 03/02/05 | CAGE CODE : 32559 SHEET # 1 OF 4 <small>CAD GENERATED DOCUMENT, DO NOT MEASURE DRAWING.</small> |
| CHECKED: T. Yin | DATE: 03/02/05 | |



| | | | |
|------|--------------|------|----------|
| REV. | DESCRIPTION | DATE | APPROVED |
| | SEE SHEET#1. | | |
| | | | |

| LED Assy. No. | Chip | | | Lens Appearance | Electro-Optical Data @ 20mA | | | | Viewing Angle 2 θ ½ (Deg) | LED P/N | |
|---------------|-----------|------------------|---------------|-----------------|-----------------------------|--------|-----|----------|---------------------------------|-----------|-----|
| | Material | Peak Wave Length | Emitted Color | | If (mA) | Vf (V) | | Iv (mcd) | | | |
| | | | | | | MAX | TYP | MAX | | | TYP |
| MPC5BWC | GaN/SiC | 430 | BLUE | WATER CLEAR | 25 | 4 | 4.5 | 25 | 20 | 5BWC-F | |
| MPC5BWD | GaN/SiC | 430 | BLUE | DIFFUSED | 25 | 4 | 4.5 | 15 | 45 | 5BWD-F | |
| MPC5BWT | GaN/SiC | 430 | BLUE | TINTED | 25 | 4 | 4.5 | 30 | 20 | 5BWT-F | |
| MPC5GC | GaP/GaP | 568 | GREEN | WATER CLEAR | 30 | 2.1 | 2.8 | 40 | 35 | 5GC-F | |
| MPC5GD | GaP/GaP | 568 | GREEN | DIFFUSED | 30 | 2.1 | 2.8 | 25 | 45 | 5GD-F | |
| MPC5GT | GaP/GaP | 568 | GREEN | TINTED | 30 | 2.1 | 2.8 | 40 | 35 | 5GT-F | |
| MPC5UGC | AlGaInP | 570 | GREEN | WATER CLEAR | 30 | 2.1 | 2.4 | 600 | 35 | 5UGC-F | |
| MPC5PGC | GaP/GaP | 555 | PURE GREEN | WATER CLEAR | 30 | 2.2 | 2.8 | 10 | 35 | 5PGC-F | |
| MPC5PGD | GaP/GaP | 555 | PURE GREEN | DIFFUSED | 30 | 2.2 | 2.8 | 10 | 45 | 5PGD-F | |
| MPC5PGT | GaP/GaP | 555 | PURE GREEN | TINTED | 30 | 2.2 | 2.8 | 10 | 35 | 5PGT-F | |
| MPC5YC | GaAsP/GaP | 590 | YELLOW | WATER CLEAR | 30 | 2 | 2.8 | 40 | 35 | 5YC-F | |
| MPC5YD | GaAsP/GaP | 590 | YELLOW | DIFFUSED | 30 | 2 | 2.8 | 25 | 45 | 5YD-F | |
| MPC5YT | GaAsP/GaP | 590 | YELLOW | TINTED | 30 | 2 | 2.8 | 40 | 35 | 5YT-F | |
| MPC5AC | GaAsP/GaP | 605 | AMBER | WATER CLEAR | 30 | 2 | 2.8 | 40 | 35 | 5AC-F | |
| MPC5AD | GaAsP/GaP | 605 | AMBER | DIFFUSED | 30 | 2 | 2.8 | 25 | 45 | 5AD-F | |
| MPC5AT | GaAsP/GaP | 605 | AMBER | TINTED | 30 | 2 | 2.8 | 40 | 35 | 5AT-F | |
| MPC5HC | GaAsP/GaP | 625 | HE RED | WATER CLEAR | 30 | 2 | 2.8 | 40 | 35 | 5HC-F | |
| MPC5HD | GaAsP/GaP | 625 | HE RED | DIFFUSED | 30 | 2 | 2.8 | 25 | 45 | 5HD-F | |
| MPC5HT | GaAsP/GaP | 625 | HE RED | TINTED | 30 | 2 | 2.8 | 40 | 35 | 5HT-F | |
| MPC5RC | GaP/GaP | 700 | RED | WATER CLEAR | 20 | 2.1 | 2.8 | 2 | 35 | 5RC-F | |
| MPC5RD | GaP/GaP | 700 | RED | DIFFUSED | 20 | 2.1 | 2.8 | 2 | 45 | 5RD-F | |
| MPC5RT | GaP/GaP | 700 | RED | TINTED | 20 | 2.1 | 2.8 | 2 | 35 | 5RT | |
| MPC5BC-A/G | GaAsP/GaP | 605 | AMBER | WHITE DIFFUSED | 30 | 2.0 | 2.8 | 6 | 45 | 5BC-A/G-F | |
| | GaP/GaP | 568 | GREEN | | 30 | 2.1 | 2.8 | 6 | | | |
| MPC5BC | GaAsP/GaP | 625 | RED | WHITE DIFFUSED | 30 | 2.0 | 2.8 | 6 | 45 | 5BC-F | |
| | GaP/GaP | 568 | GREEN | | 30 | 2.1 | 2.8 | 8 | | | |
| MPC5BC-R/Y | GaAsP/GaP | 625 | RED | WHITE DIFFUSED | 30 | 2.0 | 2.8 | 6 | 45 | 5BC-R/Y-F | |
| | GaAsP/GaP | 590 | YELLOW | | 30 | 2.0 | 2.8 | 5 | | | |
| MPC5BC-Y/G | GaAsP/GaP | 590 | YELLOW | WHITE DIFFUSED | 30 | 2.0 | 2.8 | 5 | 45 | 5BC-Y/G-F | |
| | GaP/GaP | 568 | GREEN | | 30 | 2.1 | 2.8 | 8 | | | |

| | | | |
|---|--|--|--|
| STANDARD TOLERANCE (UNLESS OTHERWISE SPECIFIED) ±10% ALL VALUES | |  BIVAR [®] 4 THOMAS, IRVINE, CA. 92618 TEL: (949) 951-8808 FAX: (949) 951-3974 | |
| ANGULAR X° ± 5° | | | |
| DESIGNED: David Green | | DATE: 03/02/05 | TITLE: STD METAL PANEL MOUNT INDICATORS PART NO: MPC5XX REVISION: G |
| CHECKED: T. Yin | | DATE: 03/02/05 | |
| | | CAGE CODE : 32559 | SHEET # 2 OF 4 |
| CAD GENERATED DOCUMENT, DO NOT MEASURE DRAWING. | | | |

| | | | |
|------|--------------|------|----------|
| REV. | DESCRIPTION | DATE | APPROVED |
| | SEE SHEET#1. | | |
| | | | |



| LED Assy. No. | Chip | | | Lens Appearance | Electro-Optical Data @ 20mA | | | | Viewing Angle 2θ ½ (Deg) | LED P/N |
|---------------|-------------|------------------|---------------|-----------------|-----------------------------|-----|-----|-------|--------------------------------|------------|
| | Material | Peak Wave Length | Emitted Color | | If | Vf | | Iv | | |
| | | | | | (mA) | (V) | | (mcd) | | |
| MAX | TYP | MAX | TYP | TYP | | | | | | |
| MPC5UBWC | InGaN/SiC | 468 | BLUE | WATER CLEAR | 76 | 3.7 | 4.5 | 2500 | 15 | 5BWC2.515F |
| MPC5SGC | GaP/GaP | 568 | GREEN | WATER CLEAR | 30 | 2.1 | 2.8 | 60 | 35 | 5SGC-F |
| MPC5SGD | GaP/GaP | 568 | GREEN | DIFFUSED | 30 | 2.1 | 2.8 | 50 | 40 | 5SGD-F |
| MPC5SGT | GaP/GaP | 568 | GREEN | TINTED | 30 | 2.1 | 2.8 | 60 | 35 | 5SGT-F |
| MPC5SYC | GaAsP/GaP | 590 | YELLOW | WATER CLEAR | 30 | 2.0 | 2.8 | 600 | 35 | 5SYC-F |
| MPC5SYD | GaAsP/GaP | 590 | YELLOW | DIFFUSED | 30 | 2.0 | 2.8 | 150 | 40 | 5SYD-F |
| MPC5SYT | GaAsP/GaP | 590 | YELLOW | TINTED | 30 | 2.0 | 2.8 | 600 | 35 | 5SYT-F |
| MPC5SRC | GaAlAs/GaAs | 645 | SUPER RED | WATER CLEAR | 30 | 1.7 | 2.4 | 60 | 35 | 5SRC-F |
| MPC5SRD | GaAlAs/GaAs | 645 | SUPER RED | DIFFUSED | 30 | 1.7 | 2.4 | 40 | 40 | 5SRD-F |
| MPC5SRT | GaAlAs/GaAs | 645 | SUPER RED | TINTED | 30 | 1.7 | 2.4 | 60 | 35 | 5SRT-F |
| MPC5UGC | AlGaInP | 570 | GREEN | WATER CLEAR | 30 | 2.1 | 2.4 | 400 | 35 | 5UGC-F |
| MPC5SUGC | AlGaInP | 570 | GREEN | WATER CLEAR | 30 | 2.1 | 2.4 | 300 | 35 | 5SUGC-F |
| MPC5UYC | AlGaInP | 590 | YELLOW | WATER CLEAR | 30 | 2.0 | 2.4 | 1000 | 30 | 5UYC-F |
| MPC5SUYC | AlGaInP | 590 | YELLOW | WATER CLEAR | 30 | 2.0 | 2.4 | 700 | 35 | 5SUYC-F |
| MPC5UUYC | AlGaInP | 590 | YELLOW | WATER CLEAR | 30 | 2.0 | 2.4 | 500 | 35 | 5UUYC-F |
| MPC5UOC | AlGaInP | 625 | ORANGE | WATER CLEAR | 30 | 1.8 | 2.4 | 1400 | 35 | 5UOC-F |
| MPC5UOC | AlGaInP | 625 | ORANGE | WATER CLEAR | 30 | 1.8 | 2.4 | 1300 | 35 | 5SUOC-F |
| MPC5URC | GaAlAs/GaAs | 645 | RED | WATER CLEAR | 30 | 1.7 | 2.4 | 400 | 30 | 5URC-F |
| MPC5SURC | AlGaInP | 640 | RED | WATER CLEAR | 30 | 1.8 | 2.4 | 500 | 35 | 5SURC-F |
| MPC5UWC | InGaN/SiC | 6500K | WHITE | WATER CLEAR | 100 | 3.5 | 4.2 | 2700 | 30 | 5WC2.730F |

| | | | |
|---|--|--|--|
| STANDARD TOLERANCE (UNLESS OTHERWISE SPECIFIED) ±10% ALL VALUES | |  BIVAR [®] 4 THOMAS, IRVINE, CA. 92618 TEL: (949) 951-8808 FAX: (949) 951-3974 | |
| ANGULAR X° ± 5° | | | |
|  | | TITLE: STD METAL PANEL MOUNT INDICATORS | |
| | | DESIGNED: David Green | DATE: 03/02/05 |
| CHECKED: T. Yin | | DATE: 03/02/05 | CAGE CODE : 32559 SHEET # 3 OF 4 |
| CAD GENERATED DOCUMENT, DO NOT MEASURE DRAWING. | | | |

| | | | |
|------|--------------|------|----------|
| REV. | DESCRIPTION | DATE | APPROVED |
| | SEE SHEET#1. | | |
| | | | |

| LED Assy. No. | Peak Wave Length λ_p (nm) | Emitted Color | Lens Appearance | Max. Rating | Electro-Optical Data @ 2mA | | | Viewing Angle 2 θ 1/2 (Deg) | LED P/N |
|---------------|--------------------------------------|---------------|-----------------|-------------|----------------------------|-----|-------------|--|---------|
| | | | | If (mA) | Vf (V) | | Iv (mcd) | | |
| | | | | MAX | TYP | MAX | TYP | | |
| MPC5BWDL | 430 | BLUE | DIFFUSED | 7 | 3.8 | 4.2 | 4 | 40 | 5BWDL-F |
| MPC5PGDL | 555 | PURE GREEN | DIFFUSED | 7 | 2.1 | 2.6 | 1 | 40 | 5PGDL-F |
| MPC5GDL | 568 | GREEN | DIFFUSED | 7 | 2.1 | 2.6 | 4 | 40 | 5GDL-F |
| MPC5YDL | 590 | YELLOW | DIFFUSED | 7 | 2.0 | 2.6 | 4 | 40 | 5YDL-F |
| MPC5ADL | 605 | AMBER | DIFFUSED | 7 | 2.0 | 2.6 | 4 | 40 | 5ADL-F |
| MPC5HDL | 625 | HE RED | DIFFUSED | 7 | 2.0 | 2.6 | 5 | 40 | 5HDL-F |
| MPC5SRDL | 645 | SUPER RED | DIFFUSED | 7 | 1.7 | 2.3 | 6 | 40 | 5SRDL-F |

| Assembly P/N | Peak Wave Length λ_p (nm) | Emitted Color | Lens Appearance | Electro-Optical Data | | | | Viewing Angle 2 θ 1/2 (Deg) | LED P/N |
|----------------|--------------------------------------|---------------|-----------------|----------------------|-----------|-----|-------------|--|----------|
| | | | | If (mA) | Vf (V) | | Iv (mcd) | | |
| | | | | MAX | TYP | MAX | TYP | | |
| 5 Volt | | | | Data @ 5V | | | | | |
| MPC5BWD5V | BLUE | 430 | DIFFUSED | - | - | 5 | 15 | 40 | 5BWD5V-F |
| MPC5GC5V | GREEN | 568 | WATER CLEAR | - | - | 5 | 40 | 40 | 5GC5V-F |
| MPC5GD5V | GREEN | 568 | DIFFUSED | - | - | 5 | 25 | 40 | 5GD5V-F |
| MPC5GT5V | GREEN | 568 | TINTED | - | - | 5 | 40 | 40 | 5GT5V-F |
| MPC5AD5V | AMBER | 605 | DIFFUSED | - | - | 5 | 25 | 40 | 5AD5V-F |
| MPC5HD5V | HE RED | 625 | DIFFUSED | - | - | 5 | 30 | 40 | 5HD5V-F |
| MPC5RD5V | RED | 700 | DIFFUSED | - | - | 5 | 1.5 | 40 | 5RD5V-F |
| MPC5YD5V | YELLOW | 590 | DIFFUSED | - | - | 5 | 25 | 40 | 5YD5V-F |
| 12 Volt | | | | Data @ 12V | | | | | |
| MPC5GC12V | GREEN | 568 | WATER CLEAR | - | - | 12 | 40 | 35 | 5GC12V-F |
| MPC5GD12V | GREEN | 568 | DIFFUSED | - | - | 12 | 25 | 40 | 5GD12V-F |
| MPC5HC12V | HE RED | 625 | WATER CLEAR | - | - | 12 | 50 | 35 | 5HC12V-F |
| MPC5HD12V | HE RED | 625 | DIFFUSED | - | - | 12 | 30 | 40 | 5HD12V-F |
| MPC5RC12V | RED | 700 | WATER CLEAR | - | - | 12 | 2 | 35 | 5RC12V-F |
| MPC5RD12V | RED | 700 | DIFFUSED | - | - | 12 | 1.5 | 40 | 5RD12V-F |
| MPC5YC12V | YELLOW | 590 | WATER CLEAR | - | - | 12 | 25 | 35 | 5YC12V-F |
| MPC5YD12V | YELLOW | 590 | DIFFUSED | - | - | 12 | 20 | 40 | 5YD12V-F |

| | | | |
|---|--|--|--|
| STANDARD TOLERANCE (UNLESS OTHERWISE SPECIFIED) $\pm 10\%$ ALL VALUES | |  BIVAR [®] 4 THOMAS, IRVINE, CA. 92618 TEL: (949) 951-8808 FAX: (949) 951-3974 | |
| ANGULAR X° \pm 5° | | | |
|  | | TITLE: STD METAL PANEL MOUNT INDICATORS | |
| | | DESIGNED: David Green | DATE: 03/02/05 |
| CHECKED: T. Yin | | DATE: 03/02/05 | CAGE CODE : 32559 SHEET # 4 OF 4 |
| CAD GENERATED DOCUMENT, DO NOT MEASURE DRAWING. | | | |