

THIS DRAWING IS UNPUBLISHED. RELEASED FOR PUBLICATION. ALL RIGHTS RESERVED.

LOC H DIST -

REVISIONS

P	LTR	DESCRIPTION	DATE	DWN	APVD
	S3	APPLICATION SPECIFICATION NUMBER ADDED	24JUL2013	KJK	RP

REFERENCE MATING INTERFACE PATTERN:
1,27 STAGGERED PITCH x 1,5 ROW-DISTANCE.

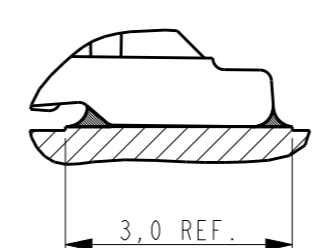
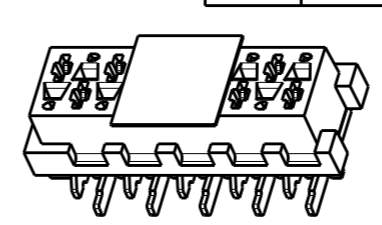
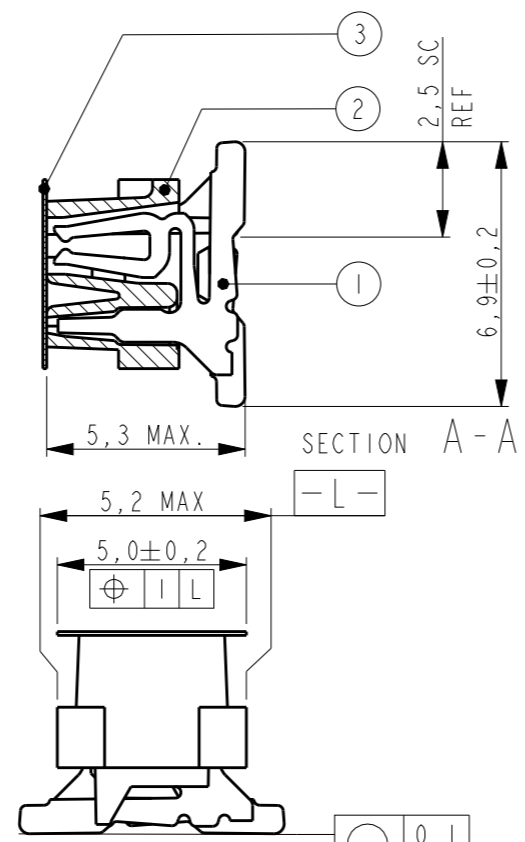
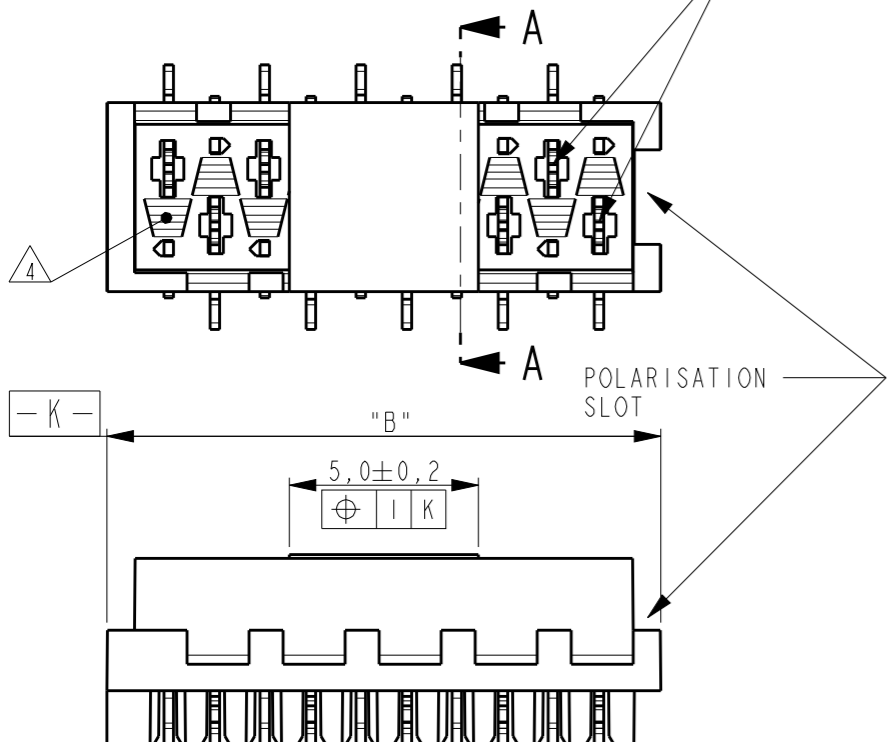

1 PARTNUMBER VAC. TAPE.	3 PARTNUMBER	NR. OF POS. "n"	"A"	"B" MAX.
7-188275-4	0-188275-4	4	3,81	7,1
7-188275-6	0-188275-6	6	6,35	9,7
7-188275-8	0-188275-8	8	8,89	12,2
8-188275-0	1-188275-0	10	11,43	14,7
8-188275-2	1-188275-2	12	13,97	17,3
8-188275-4	1-188275-4	14	16,51	19,8
8-188275-6	1-188275-6	16	19,05	22,4
8-188275-8	1-188275-8	18	21,59	24,9
9-188275-0	2-188275-0	20	24,13	27,5

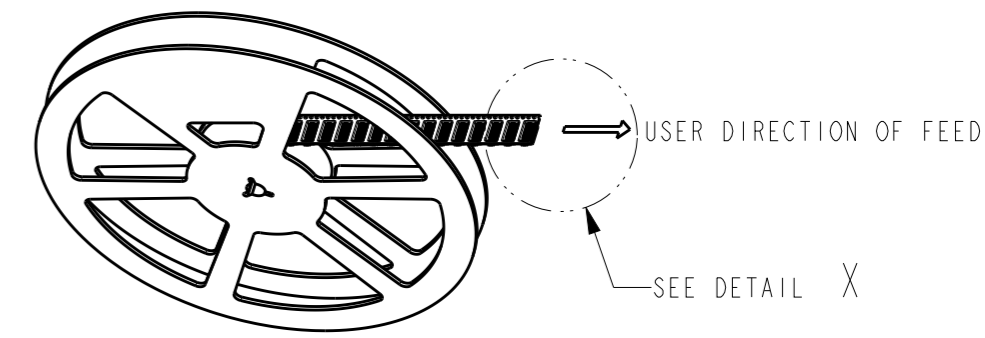
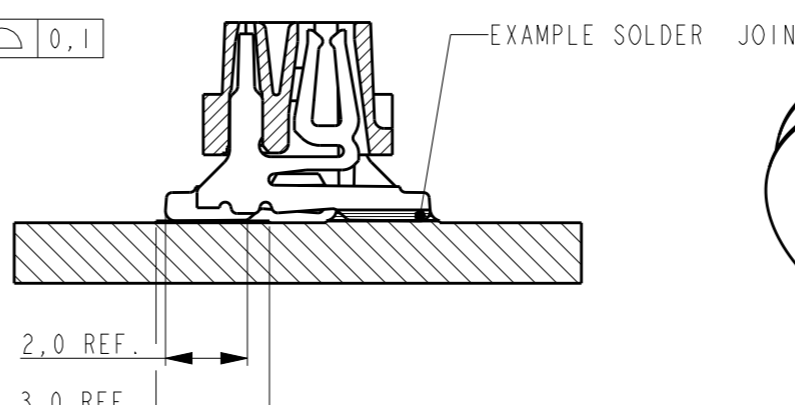
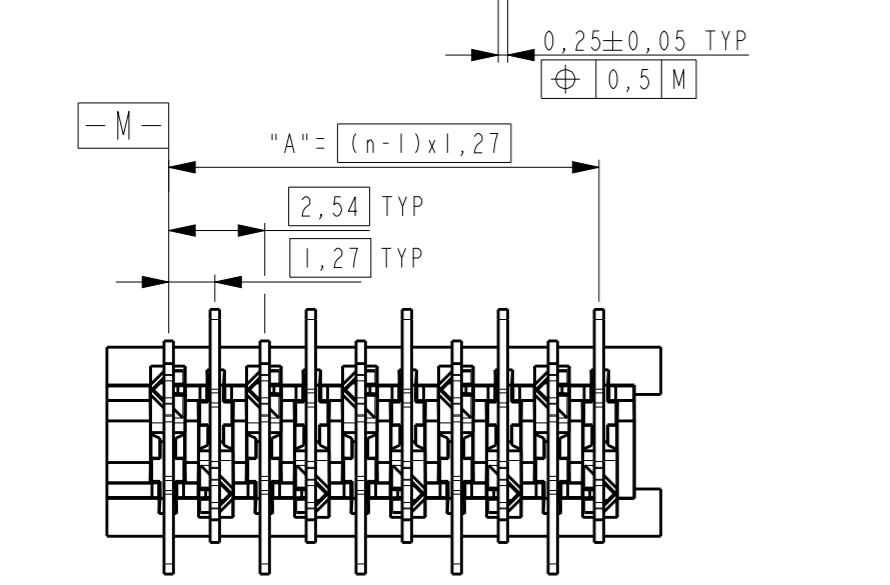

- NOTES:
- 1 TAPE FOR VACUUM P&P ONLY FOR DASHNUMBERS 7- /8- /9-
 - 2 FOR PACKAGING SEE SHEET 2 OF 2
 - 3 WITHOUT VACUUM TAPE.
 - 4 CORING-OUTS FOR MANUFACTURING PURPOSE ONLY. SHAPE MAY VARY, BUT IS NOT FUNCTIONAL FOR THE APPLICATION.
 - 5 SHOWN IS A 10 POSITION CONNECTOR.

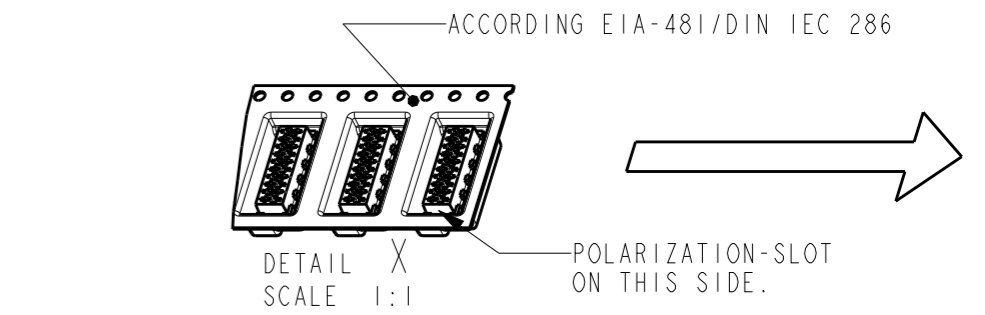
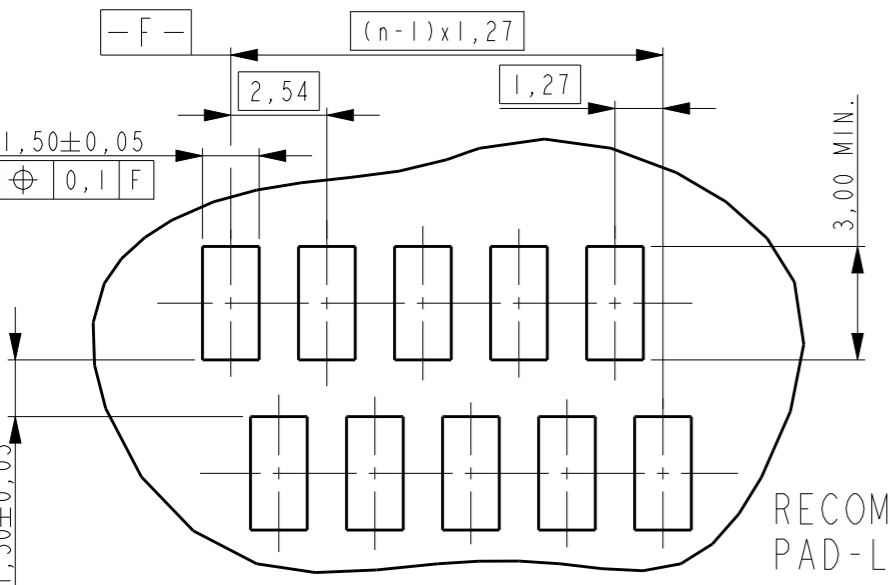

ITEM NO.	COMPONENT DESCRIPTION	MATERIAL	FINISH / COLOR
3	PICK & PLACE TAPE	KAPTON	AMBER TRANSPARENT
2	FEMALE HOUSING	POLYAMIDE 4/6,GF	RED
1	FEMALE CONTACT	PHOSPHOR BRONZE	TIN OVER NICKEL

THIS DRAWING IS A CONTROLLED DOCUMENT.

DWN M. GOSSELINK
CHK -
APVD -

PRODUCT SPEC 108-19052
APPLICATION SPEC 114-13318
WEIGHT -

CUSTOMER DRAWING

STE TE Connectivity

CONNECTOR, FEMALE-ON-BOARD TOP-ENTRY, SMD, Micro-MatCh

SIZE A3 CAGE CODE 00779 DRAWING NO C-188275 RESTRICTED TO -

SCALE 5:1 SHEET 1 OF 2 REV S3

THIS DRAWING IS UNPUBLISHED.

RELEASED FOR PUBLICATION

© COPYRIGHT -

ALL RIGHTS RESERVED.

LOC H DIST -

P LTR

REVISIONS

DESCRIPTION

DATE

DWN

APVD

SEE SHEET 1

TAPE WIDTH 24 mm

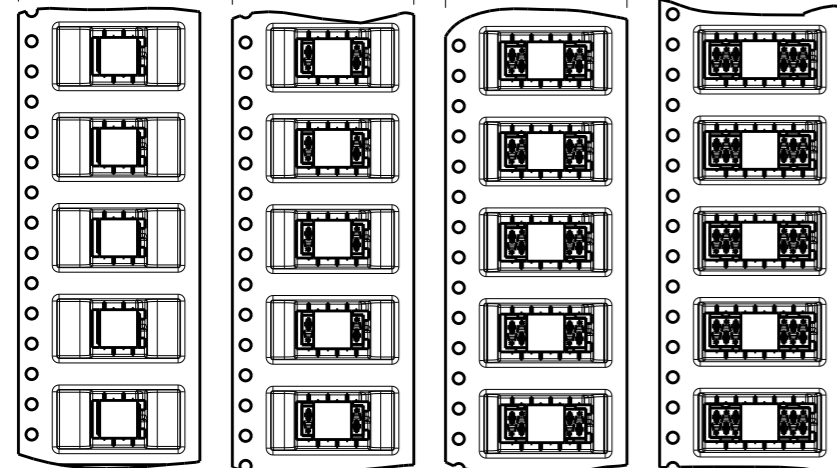

7-188275-4 4 POSITION 0-188275-4
7-188275-6 6 POSITION 0-188275-6
7-188275-8 8 POSITION 0-188275-8
8-188275-0 10 POSITION 1-188275-0

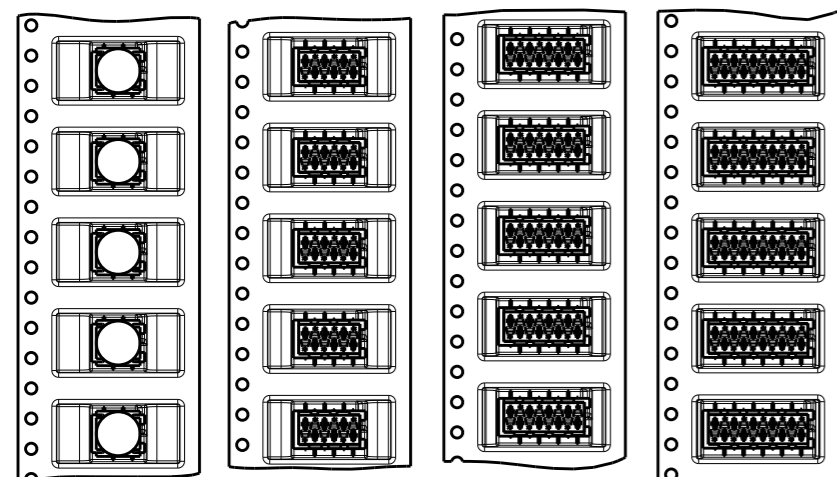

TAPE WIDTH 44 mm

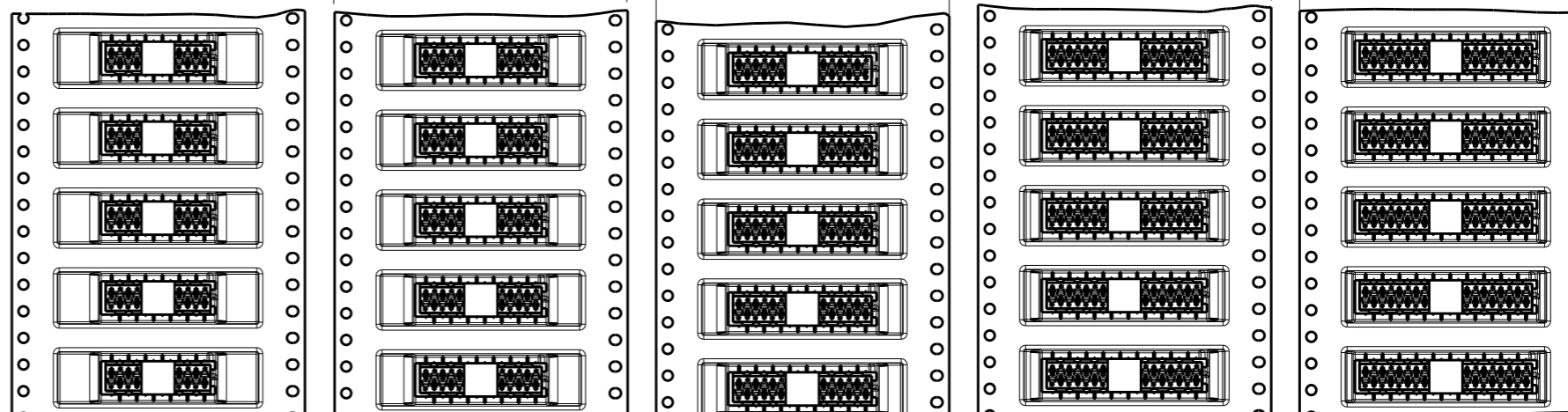

8-188275-2 12 POSITION 1-188275-2
8-188275-4 14 POSITION 1-188275-4
8-188275-6 16 POSITION 1-188275-6
8-188275-8 18 POSITION 1-188275-8
9-188275-0 20 POSITION 2-188275-0

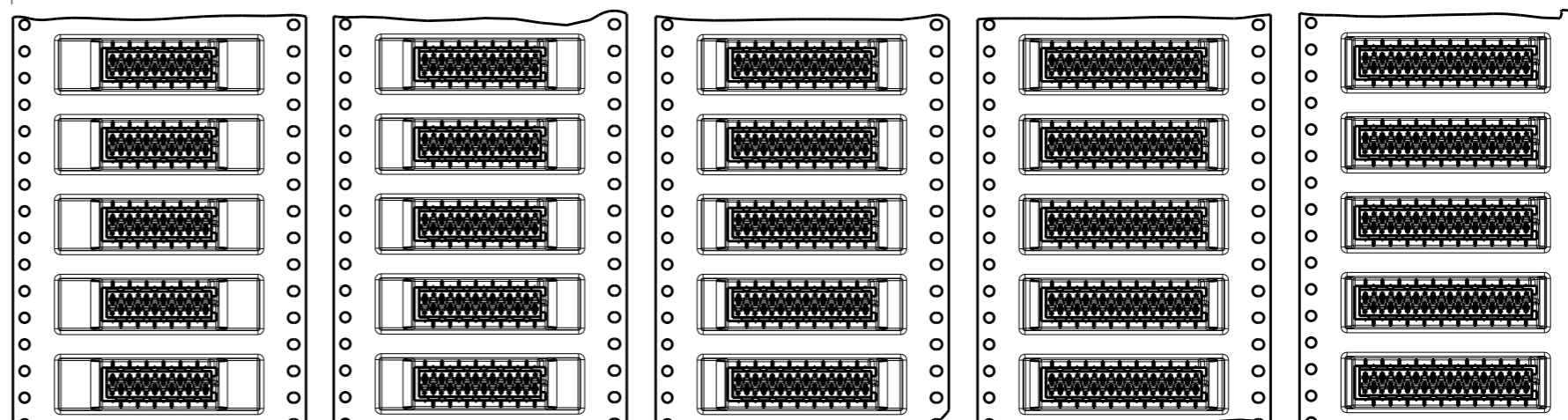

THIS DRAWING IS A CONTROLLED DOCUMENT.

DWN M. GOSSELINK
CHK -
APVD -



DIMENSIONS:

mm

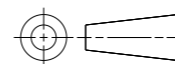

TOLERANCES UNLESS OTHERWISE SPECIFIED:

0 PLC ±-
1 PLC ±0.1
2 PLC ±0.05
3 PLC ±-
4 PLC ±-
ANGLES ±-
FINISH -

PRODUCT SPEC 108-19052
APPLICATION SPEC 114-13318

NAME CONNECTOR, FEMALE-ON-BOARD TOP-ENTRY, SMD, Micro-MaTch

MATERIAL -

WEIGHT -

SIZE A3 CAGE CODE 00779 DRAWING NO C-188275 RESTRICTED TO -

CUSTOMER DRAWING

SCALE 1:1 SHEET 2 OF 2 REV S3