

TECHNICAL CHARACTERISTICS

MATERIAL
 INSULATOR: LCP
 COLOR: BLACK
 CONTACT MATERIAL: COPPER ALLOY
 CONTACT TYPE: STAMPED
 CONTACT PLATING: SELECTIVE GOLD
 SHIELDING: BRASS NI PLATED
 QUALITY CLASS: 1500 MATING CYCLES

ENVIRONMENTAL
 OPERATING TEMPERATURE: -40 UP TO 105°C
 FLAMABILITY RATING: UL94-V0
 COMPLIANCE: LEAD FREE AND ROHS

ELECTRICAL
 CURRENT RATING: 1.5 A max
 WORKING VOLTAGE: 30V AC
 INSULATOR RESISTANCE: >1000 MOHM
 DIELECTRIC WITHSTANDING VOLTAGE: 750V AC/MN
 CONTACT RESISTANCE: 20 mOHM MAX



STANDARD
 CERTIFIED: E323964 / MODEL NUMBER 629-1139

SOLDERING
 REFLOW PROCESS ONLY

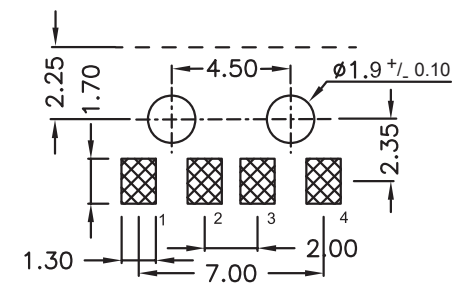
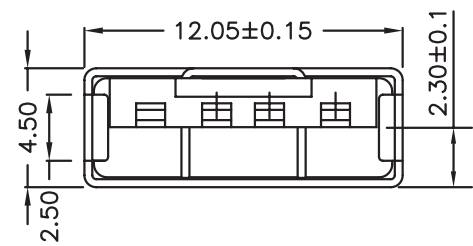
PACKAGING
 TUBE

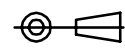

PCB LAYOUT - COMPONENT VIEW

RoHS Compliant				PROJECTION: 	GENERAL TOLERANCE .X = +/- 0.2 .XX = +/- 0.15		DESCRIPTION: USB 2.0 TYPE A SMT WITH CLIP	SIZE A4
L	18-FEB-13	DESIGNATION	AR					
K	31-AUG-12	LAYOUT	GG					
J	08-NOV-11	CURRENT RATING	GG					
I	22-JUN-11	CURRENT RATING	GG					
H	25-OCT-10	NEW DIM	GG					
REV	DATE	FILE	BY	APPROVAL: RJ	UNIT: MM SCALE: SHEET: 1/2 DRAW: PEARL	WERI PART NO: 629 004 113 921		

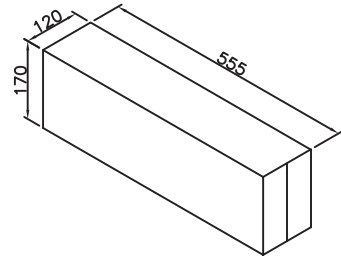
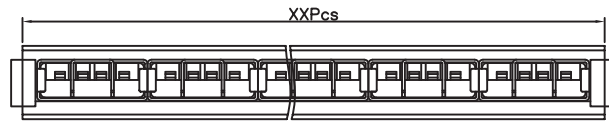
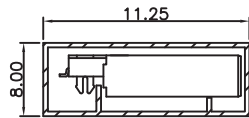
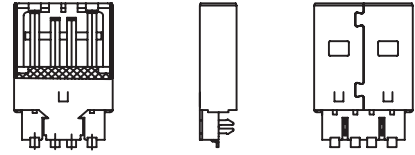

Inner Carton (SC 1:40)

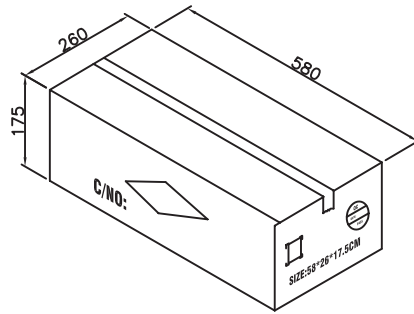

Carton (SC 1:40)

Note:
 1,Dimension
 Tube Size: L=540mm
 Inner Carton Size:555(L)X120(W)X170(H) (mm)
 Carton Size:580(L)X260(W)X175(H) (mm)

Pin.	Pcs/Tube	Tube/Inner Carton	Pcs/Inner Carton	Pcs/Carton
04	43	120	5160	10320

RoHS Compliant

G			
F			
E			
D			
C			
B			
A			
REV	DATE	FILE	BY

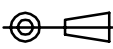
PROJECTION:

APPROVAL: RJ

GENERAL TOLERANCE
 .X = +/- 0.2
 .XX = +/- 0.15

UNIT: MM
 SCALE:
 SHEET: 2/2
 DRAW: PEARL



DESCRIPTION: USB TYPE A SMT WITH CLIP
 WERI PART NO: 629 004 113 921

SIZE
A4