

1

2

3

4

5

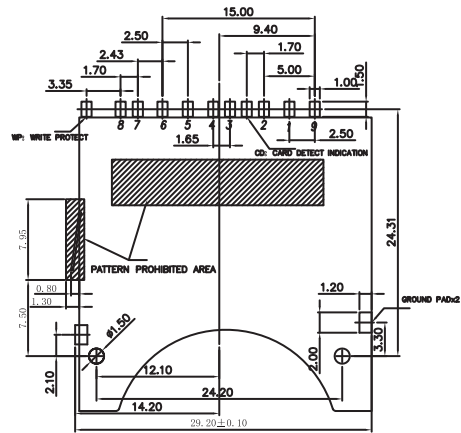
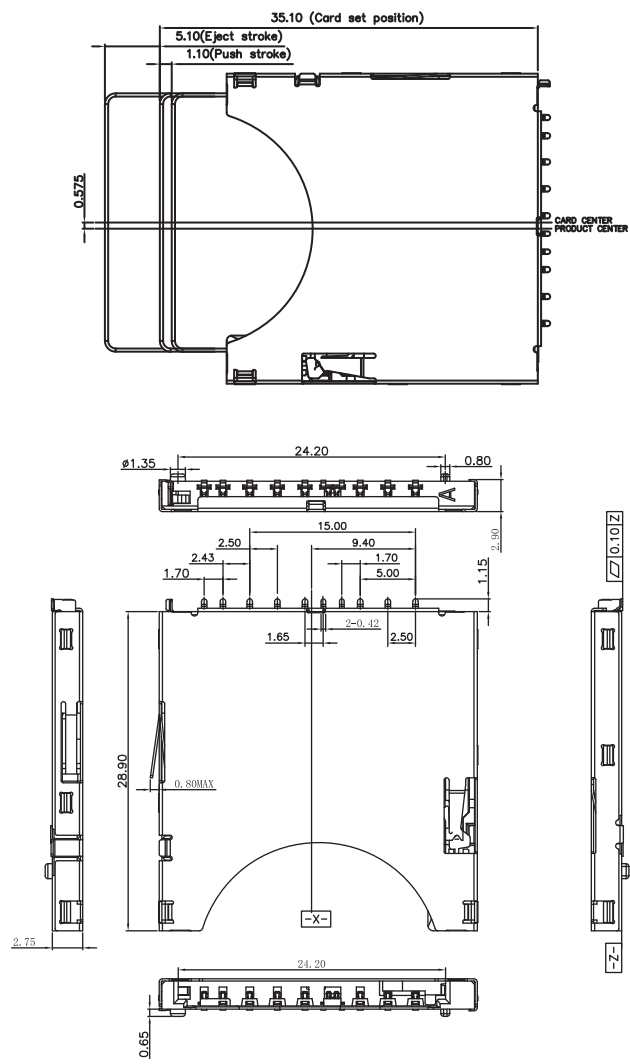

PCB LAYOUT - COMPONENT VIEW

TECHNICAL CHARACTERISTICS

MATERIAL
 INSULATOR: LCP
 FLAMABILITY RATING: UL94-V0
 COLOR: BLACK
 CONTACT MATERIAL: COPPER ALLOY
 CONTACT TYPE: STAMPED
 CONTACT PLATING: SELECTIVE GOLD
 SHIELDING: STAINLESS STEEL
 QUALITY CLASS: 10000 MATING CYCLES

ENVIRONMENTAL
 OPERATING TEMPERATURE: -25 UP TO 85°C
 COMPLIANCE: LEAD FREE AND ROHS

ELECTRICAL
 CURRENT RATING: 0.5A
 WORKING VOLTAGE: 100VAC
 INSULATOR RESISTANCE: >1000 MOHM
 DIELECTRIC WITHSTANDING VOLTAGE: 500VAC/MN
 CONTACT RESISTANCE: 100 MOHM MAX

SOLDERING
 REFLOW PROCESS ONLY

PACKAGING
 TAPE & REEL

PIN No	Name	DESCRIPTION
1	CD/DAT3	Connector data line 3
2	CMD	COMMAND/ANSWER
3	Vss1	GND
4	Vdd	POWER SUPPLY
5	CLK	GLOCK
6	Vss2	GND
7	DAT0	Connector data line 0
8	DAT1	Connector data line 1
9	DAT2	Connector data line 2

RoHS Compliant			
I	02-FEB-15	LAYOUT	QL
H	06-JAN-15	DIMENSIONS	QP
REV	DATE	FILE	BY

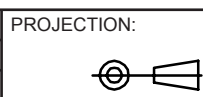

GENERAL TOLERANCE
 .X = +/- 0.2
 .XX = +/- 0.15



APPROVAL: NP

UNIT: MM
 SCALE:
 SHEET: 1/3
 DRAW: VICKY

DESCRIPTION: SD Card Connector - Push & Push - With Card Detection
 9 pins
 WERI PART NO: 693 061 010 911

SIZE
A4

A

B

C

D

1

2

3

4

5

A

B

C

D

Contact OFF

Contact ON / Lock OFF

Contact ON / LOCK ON



DETAIL U



DETAIL S



DETAIL T



DETAIL W

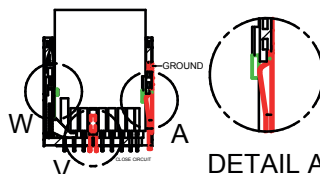

DETAIL A



DETAIL V

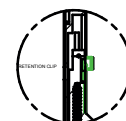

DETAIL Y

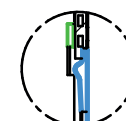
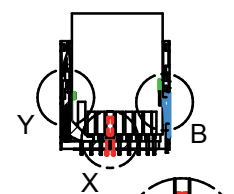

DETAIL B

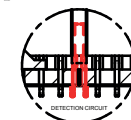

DETAIL X

Card detection switch		Write protection switch		
Card removed	Card inserted	Card removed	Card inserted	
			Write Protect	Write enable
OPEN	CLOSE	OPEN	OPEN	CLOSE

RoHS Compliant

PROJECTION:

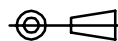

GENERAL TOLERANCE

.X = +/- 0.2

.XX = +/- 0.15



APPROVAL: RJ

UNIT: MM

SCALE:

SHEET: 2/3

DRAW: VICKY

DESCRIPTION: SD Card Connector - Push & Push - With Card Detection
9 pins

WERI PART NO: 693 061 010 911

SIZE

A4

REV	DATE	FILE	BY
-----	------	------	----

1

2

3

4

5

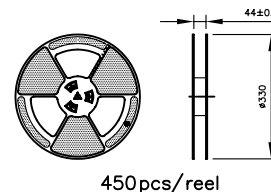
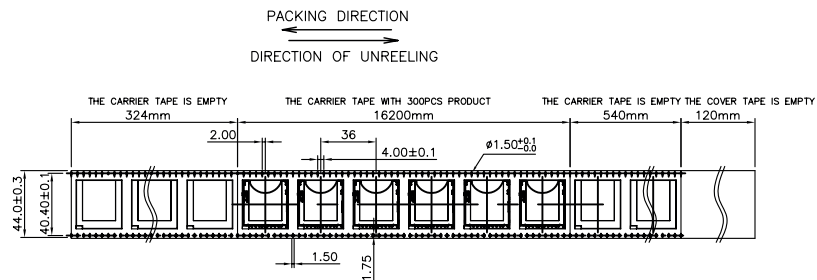
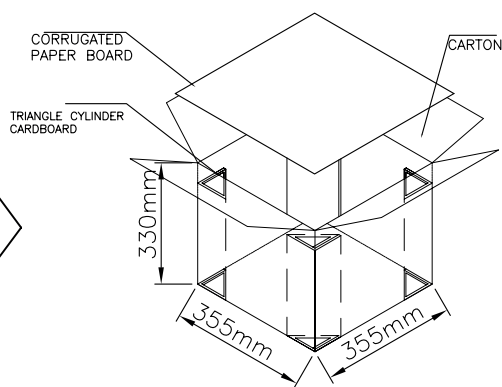
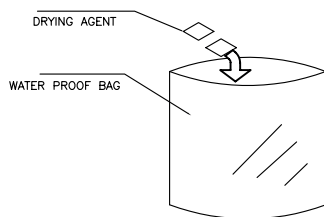
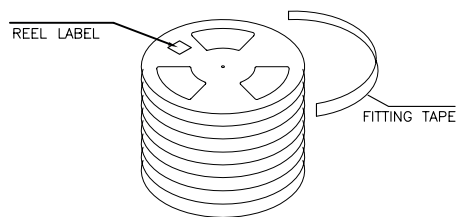
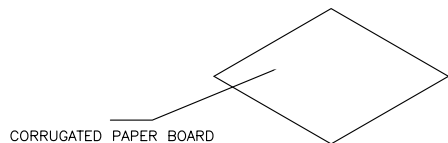

NOTES
1. MATERIALS: PS
2. PACKING: TAPE REEL(450PCS/REEL,3150PCS/CARTON)
3. SONY SS-00259 or RoHS
All Material in According With The RoHS Environment Related Substances List Controlled.

RoHS Compliant

REV	DATE	FILE	BY

PROJECTION:

GENERAL TOLERANCE
.X = \pm 0.2
.XX = \pm 0.15



APPROVAL: RJ

UNIT: MM
SCALE:
SHEET: 3/3
DRAW: VICKY

DESCRIPTION: SD Card Connector - Push & Push - With Card Detection
9 pins
WERI PART NO: 693 061 010 911

SIZE
A4

A

B

C

D