



TABLE OF CONTENTS	
SHEET NO.	SHEET DESCRIPTION
1	NOTES AND BOM
2	CONFIGURATIONS
3-4	KEY CONFIGURATIONS
5	RECEPTACLE CONNECTOR ASSEMBLY
6	BACKSHELL NOTES
7	BACKSHELL
8	BACKSHELL CONFIGURATIONS

NOTES: VALID UNLESS OTHERWISE SPECIFIED

1. GENERAL:
- a. APPLICATION SPECIFICATION SEE: AS-33472-100  
 -CONTAINS: PRODUCT INTRODUCTION, PRODUCT SUMMARY, CONNECTOR ASSEMBLY, PACKAGING INFORMATION, CONNECTOR MATING, SERVICE INSTRUCTIONS, ELECTRICAL CONTINUITY CHECKING, CRIMPING, AND TROUBLESHOOTING.  
 -DESIGNED TO MATE WITH DEVICE OR CONNECTOR AS SPECIFIED IN THE MATING INTERFACE/CONNECTOR DRAWINGS CHART.  
 \*DENOTES DRAWINGS THAT CAN BE ACCESSED AT <http://ewcap.uscarteams.org/>.  
 -ASSEMBLY SHIPPED WITH PLR IN PRE-LOCK POSITION (SEE PLR PRE-LOCK VIEW SHEET 5).

- b. PRODUCT SPECIFICATION SEE:  
 -STANDARD CONFIGURATION: PS-33472-000  
 -TRANSMISSION CONFIGURATION: TS-160038-0001  
 -UL V0 CONFIGURATION: TBD  
 CONTAINS: PRODUCT INTRODUCTION, PRODUCT SUMMARY, RATINGS (CURRENT, TEMPERATURE, SEALING, AND FLAMMABILITY), TERMINALS, WIRE DIAMETER RANGE, PRODUCT VALIDATION, AND PRODUCT DEVIATIONS.

- c. PACKAGING SPECIFICATION PER MOLEX DRAWING; SEE PACKAGING CHART  
 d. PARTS MUST BE IN COMPLIANCE TO MOLEX CHEMICAL SUBSTANCES FOR PRODUCTS AND PACKAGING SPECIFICATION: OEHS-699000-301  
 e. DATA MUST BE SUBMITTED UNDER THE MOLEX PART NUMBER TO IMDS (COMPANY ID#13255)

2. DESIGN - MATERIALS:

- a. FOR BILL OF MATERIALS SEE:  
 -STANDARD CONFIGURATION SD-33472-0002  
 -TRANSMISSION CONGRURATION SD-160038-0002  
 -UL V0 CONFIGURATION SD-160074-0002
- b. TRANSMISSION CONNECTOR COMPONENTS MUST MEET THE MATERIAL REQUIREMENTS SPECIFIED IN TS-160038-0001

3. DESIGN - GEOMETRY:

- a. THE 3-D CAD DATA IS BASIC (WITHOUT TOLERANCE) AND MASTER FOR THIS PART WITH THE EXCEPTION OF UNDERLINED DIMENSIONS. DIMENSIONAL INFORMATION NOT SHOWN ON THIS DRAWING IS DEFINED BY THE DATA FILE AT ITS LATEST REVISION.
- b. GEOMETRIC DIMENSIONS AND TOLERANCES PER ASME Y14.5M-2009
- c. EDGES AND UNDIMENSIONED DETAILS PER ISO13715
- d. CORNERS SHOWN AS SHARP TO BE R 0.2 MAX.
- e. LETTERING SHALL BE 0.15 MAX RAISED IN 0.25 MAX RECESS PAD. THIS INCLUDES RECYCLING CODE, CAVITY ID, VENDOR IDENTIFICATION, AND CUSTOMER MATERIAL NUMBER.
- f. VISUAL DEFECTS SHALL MEET COSMETIC STANDARD PS-45499-002 (Class B).
- g. LASER MARKING:  
 1. PART NUMBER  
 2. DAY OF THE YEAR  
 3. SHIFT  
 4. YEAR  
 FOR ADDITIONAL INFORMATION SEE SECTION 5 UNDER PROCEDURES IN ES-34735-008.

PACKAGING	
DESCRIPTION	DRAWING NO.
2X2	PK-31300-635
2X3	PK-31300-903
2X4	PK-31300-903
2X6	PK-31300-903
2X8	PK-31300-903
2X10	PK-31300-903

MATING INTERFACE/CONNECTOR DRAWINGS		
DESCRIPTION	INTERFACE DEFINITION	MOLEX INLINE
STANDARD 2X2	*150-S-004-2-Z02	SD-33482-041
UL V0 2X2	*150-S-004-2-Z02	SD-33482-0001
STANDARD 2X3	*150-S-006-2-Z02	SD-33482-061
TRANSMISSION 2X3	*150-S-006-2-Z02	N/A
STANDARD 2X4	*150-S-008-2-Z02	SD-33482-081
UL V0 2X4	*150-S-008-2-Z02	SD-33482-0001
STANDARD 2X6	*150-S-012-2-Z01	SD-33482-0001
STANDARD 2X8	*150-S-016-2-Z01	SD-33482-0001
STANDARD 2X10	E-33472-201	SD-33482-0001
UL V0 2X10	E-33472-201	SD-33482-0001

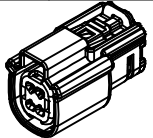

2x2

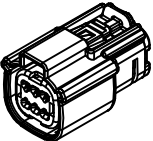

2x3

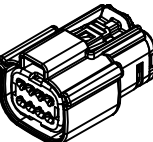

2x4

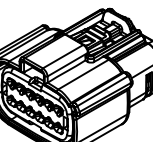

2x6

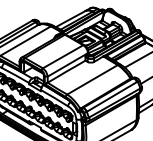

2x8

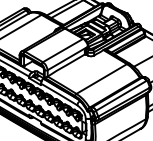

2x10

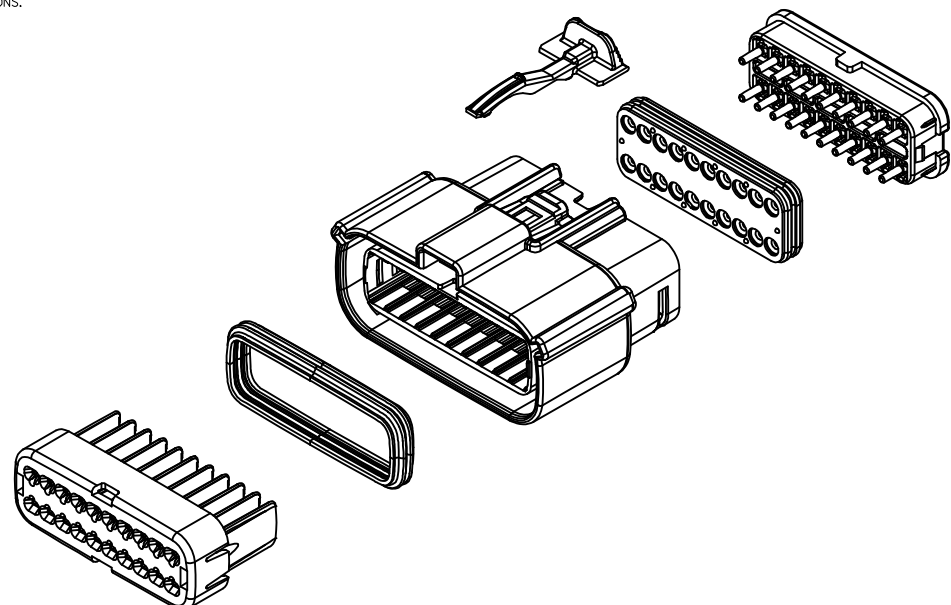

INSPECTION NUMBER LOG	
LAST NUMBER: 10	ADDED:
REMOVED:	

A4	ADD UL V0 CONFIGURATIONS
A3	ADDED 2X3 STD AND TRANSMISSION
A2	UPDATED 2X8 BLD DRAWINGS
A1	FIXED TYPO IN NOTE 1a, UPDATED 2X6 MOLEX INLINE BLADE DRAWING
A	INITIAL RELEASE

<b>ENTER DESCRIPTION</b> EC NO: UA0205-1759 DRWNA PROFFITT 2015/05/22 CHKOKBERUSZENSK 2015/06/03 APPR:VKOSHY 2015/06/04	<b>QUALITY SYMBOLS</b> ∇=0 ∇=0 ∇=0	<b>GENERAL TOLERANCES (UNLESS SPECIFIED)</b>		<b>DIMENSION STYLE</b> MM ONLY		<b>SCALE</b> 1.5:1	<b>DESIGN UNITS</b> METRIC	THIRD ANGLE PROJECTION				
		4 PLACES ± --- ± ---	3 PLACES ± --- ± ---	2 PLACES ± 0.10 ± ---	1 PLACE ± 0.2 ± ---				0 PLACE ± --- ± ---	DRAWN BY DATE APROFFITT 2014/05/14	TITLE MX150 RCPT DUAL ROW SEALED ASSEMBLY MAT SEAL	
		DRAFT WHERE APPLICABLE MUST REMAIN WITHIN DIMENSIONS							CHECKED BY DATE APPROVED BY DATE VKOSHY 2014/06/27	DOCUMENT NO. SD-33472-0001	SHEET NO. 1 OF 8	
		THIS DRAWING CONTAINS INFORMATION THAT IS PROPRIETARY TO MOLEX INCORPORATED AND SHOULD NOT BE USED WITHOUT WRITTEN PERMISSION										

**SHEET DESCRIPTION**

CONFIGURATIONS

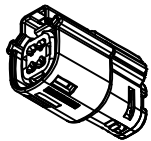

2X2 - STANDARD (STD)

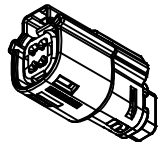

2X2 - LENGTHENED

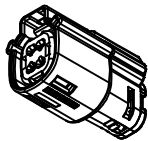

2X2 - UL V0 CONFIGURATION †

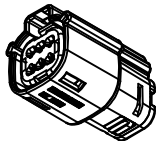

2X3 - STANDARD (STD)

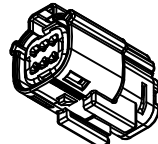

2X3 - STANDARD (STD)  
WITH CLIPSLOT \*

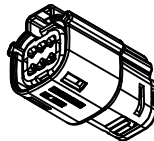

2X3 - TRANSMISSION FLUID CONFIGURATION †

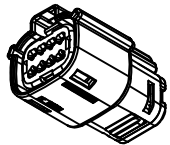

2X4 - STANDARD (STD)

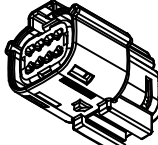

2X4 - STANDARD (STD)  
WITH CLIPSLOT \*

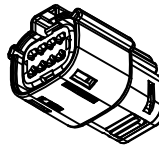

2X4 - UL V0 CONFIGURATION †

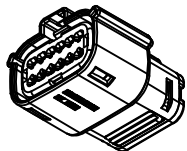

2X6 - STANDARD (STD)

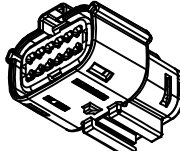

2X6 - STANDARD (STD)  
WITH CLIPSLOT \*

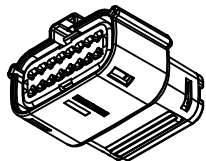

2X8 - STANDARD (STD)

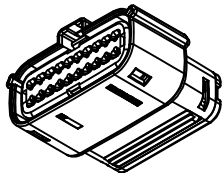

2X10 - STANDARD (STD)

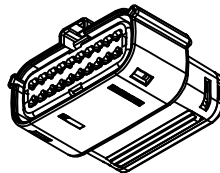

2X10 - UL V0 CONFIGURATION †

\* WITH CLIPSLOT CONFIGURATION DOES NOT MEET THE USCAR PACKAGING FRAME REQUIREMENTS

† SAME GEOMETRY AS STANDARD CONFIGURATION. SEE NOTES 2b-c FOR MORE INFORMATION

<b>ENTER DESCRIPTION</b> EC NO: UAU2015-1759 DRAWN/PROF/ITT: 2015/05/22 CHK/DK/BORUSZENSKI 2015/06/03 APPR:VKOSHY 2015/06/04	QUALITY SYMBOLS ▽=0 ▽=0 ▽=0	GENERAL TOLERANCES (UNLESS SPECIFIED)		DIMENSION STYLE <b>MM ONLY</b>		SCALE <b>1.5:1</b>	DESIGN UNITS <b>METRIC</b>	THIRD ANGLE PROJECTION						
		4 PLACES ±--- ±---	3 PLACES ±--- ±---	2 PLACES ±0.10 ±---	1 PLACE ±0.2 ±---	0 PLACE ±--- ±---	ANGULAR ± 1 °	DRAFT WHERE APPLICABLE MUST REMAIN WITHIN DIMENSIONS	DRAWN BY DATE APROFF/ITT 2014/05/14	CHECKED BY DATE	APPROVED BY DATE VKOSHY 2014/06/27	MATERIAL NO.	DOCUMENT NO. <b>SD-33472-0001</b>	SHEET NO. 2 OF 8
		SEE NOTE 2a.		THIS DRAWING CONTAINS INFORMATION THAT IS PROPRIETARY TO MOLEX INCORPORATED AND SHOULD NOT BE USED WITHOUT WRITTEN PERMISSION										
		SEE NOTE 2a.		THIS DRAWING CONTAINS INFORMATION THAT IS PROPRIETARY TO MOLEX INCORPORATED AND SHOULD NOT BE USED WITHOUT WRITTEN PERMISSION										

**SHEET DESCRIPTION**  
KEY CONFIGURATIONS

**2X2**

**2X3**

**2X4**

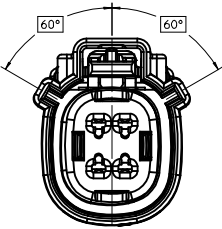

KEY A

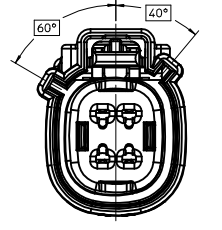

KEY B

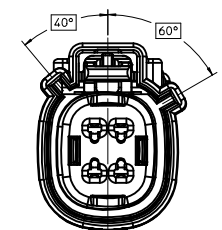

KEY C

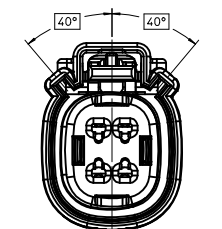

KEY D

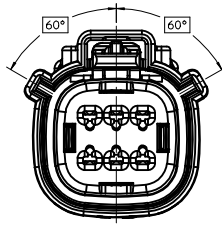

KEY A

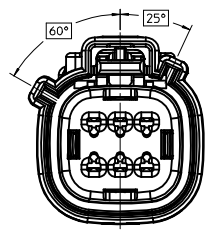

KEY B

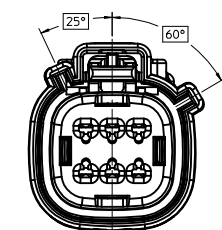

KEY C

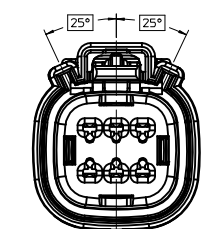

KEY D

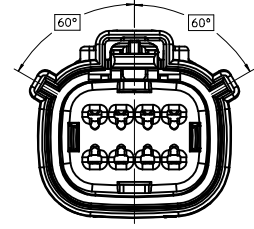

KEY A

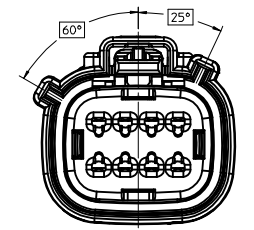

KEY B

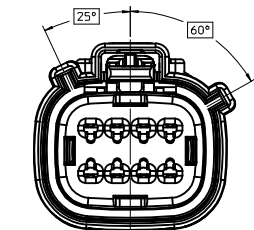

KEY C

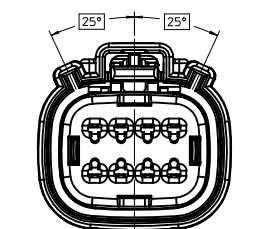

KEY D

<b>ENTER DESCRIPTION</b> EC NO: UAU2015-759 DRAWN: APROFF ITT 2015/05/22 CHKD: KEBORUS ZENSK 2015/06/03 APPR: VKOSHY 2015/06/04	QUALITY SYMBOLS ▽=0 ▽=0 ▽=0	GENERAL TOLERANCES (UNLESS SPECIFIED)		DIMENSION STYLE <b>MM ONLY</b>		SCALE 3:1	DESIGN UNITS METRIC	THIRD ANGLE PROJECTION	
		4 PLACES ± --- ± ---	mm INCH	DRAWN BY APROFF ITT	DATE 2014/05/14	TITLE MX150 RCPT DUAL ROW SEALED ASSEMBLY MAT SEAL			
		3 PLACES ± --- ± ---	2 PLACES ± 0.10 ± ---	CHECKED BY	DATE	MATERIAL NO. SEE NOTE 2a.			
		1 PLACE ± 0.2 ± ---	0 PLACE ± --- ± ---	APPROVED BY VKOSHY	DATE 2014/06/27	DOCUMENT NO. SD-33472-0001	SHEET NO. 3 OF 8		
DRAFT WHERE APPLICABLE MUST REMAIN WITHIN DIMENSIONS		THIS DRAWING CONTAINS INFORMATION THAT IS PROPRIETARY TO MOLEX INCORPORATED AND SHOULD NOT BE USED WITHOUT WRITTEN PERMISSION							

**SHEET DESCRIPTION**

KEY CONFIGURATIONS CONT.

**2X6**

**2X8**

**2X10**

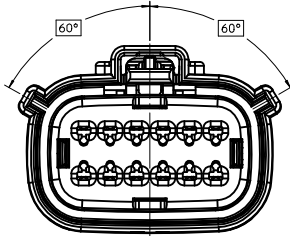

KEY A

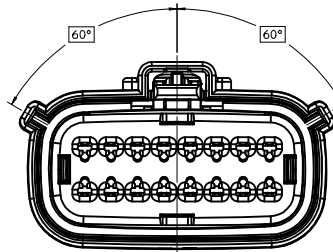

KEY A

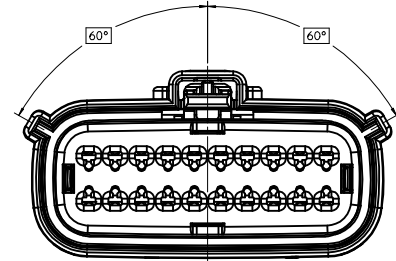

KEY A

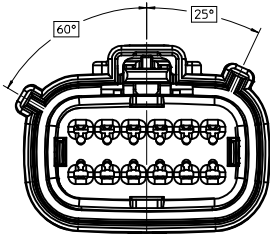

KEY B

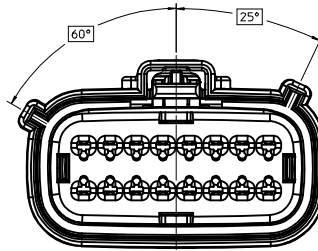

KEY B

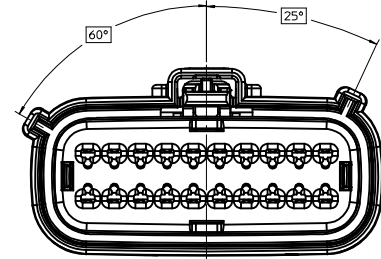

KEY B

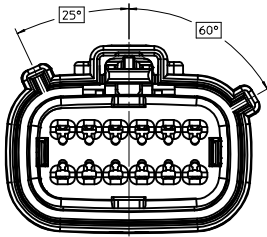

KEY C

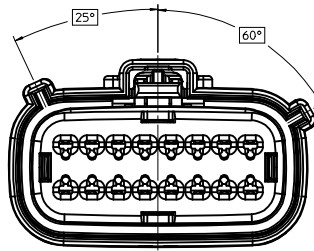

KEY C

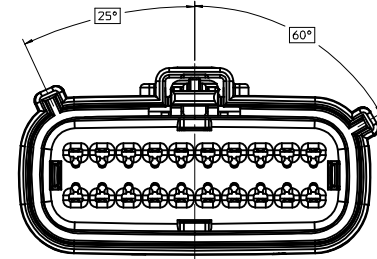

KEY C

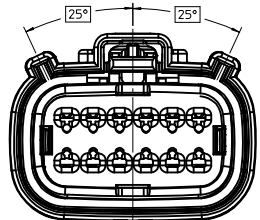

KEY D

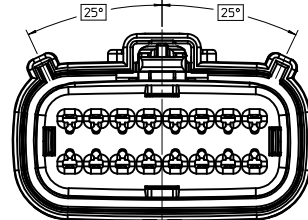

KEY D

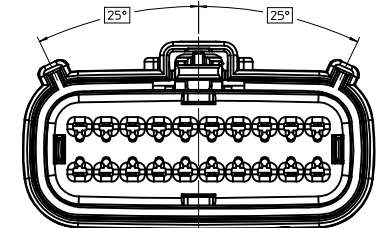

KEY D

<b>ENTER DESCRIPTION</b> ELEC NO: UA02015-759 DRAWN BY: ITT 2015/05/22 CHKD BY: BORUSZENSK 2015/06/03 APPR: VKOSHY 2015/06/04	<b>QUALITY SYMBOLS</b> ∇=0 ∇=0 ∇=0	<b>GENERAL TOLERANCES (UNLESS SPECIFIED)</b>		<b>DIMENSION STYLE</b> MM ONLY	<b>SCALE</b> 3:1	<b>DESIGN UNITS</b> METRIC	THIRD ANGLE PROJECTION	
		4 PLACES ± --- ± --- 3 PLACES ± --- ± --- 2 PLACES ± 0.10 ± --- 1 PLACE ± 0.2 ± --- 0 PLACE ± --- ± ---	mm INCH	DRAWN BY DATE APPROFF ITT 2014/05/14	CHECKED BY DATE	TITLE MX150 RCPT DUAL ROW SEALED ASSEMBLY MAT SEAL		SHEET NO. 4 OF 8
		ANGULAR ± 1°		APPROVED BY DATE VKOSHY 2014/06/27	DOCUMENT NO. SD-33472-0001		THIS DRAWING CONTAINS INFORMATION THAT IS PROPRIETARY TO MOLEX INCORPORATED AND SHOULD NOT BE USED WITHOUT WRITTEN PERMISSION	
		DRAFT WHERE APPLICABLE MUST REMAIN WITHIN DIMENSIONS		SEE NOTE 2a.				

**SHEET DESCRIPTION**  
RECEPTACLE CONNECTOR ASSEMBLY

DESCRIPTION	DIMENSIONS						
	A	B	C	D	E	F	G
2X2 STANDARD	18.58	1.75	25.45	24.81	37.65	N/A	2.75±0.50
2X2 LENGTHENED	18.58	1.75	25.45	24.81	42.25	N/A	2.75±0.50
2X3 W/ CLIPSLOT	22.25	3.50	30.50	N/A	37.65	27.96	4.0±0.4
2X3 W/O CLIPSLOT	22.25	3.50	26.24	24.90	37.65	N/A	4.0±0.4
2X4 W/ CLIPSLOT	25.75	1.75	31.50	N/A	37.65	28.00	2.75±0.50
2X4 W/O CLIPSLOT	25.75	1.75	29.19	24.81	37.65	N/A	2.75±0.50
2X6 W/ CLIPSLOT	32.75	1.75	35.58	N/A	37.65	27.76	2.75±0.50
2X6 W/O CLIPSLOT	32.75	1.75	35.58	24.90	37.65	N/A	2.75±0.40
2X8 W/O CLIPSLOT	39.80	1.75	42.25	24.90	37.65	N/A	4.0±0.4
2X10 W/O CLIPSLOT	46.75	1.75	49.05	24.90	37.65	N/A	2.75±0.50

LASER MARKING ON THIS SURFACE  
SEE NOTE 3g.

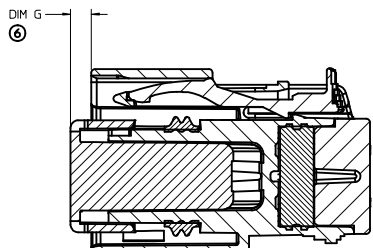
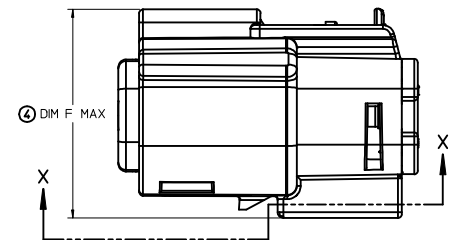
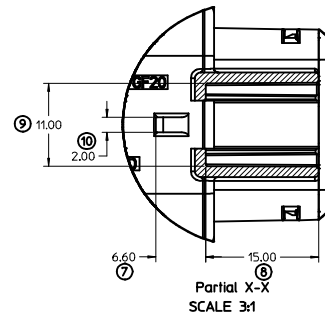
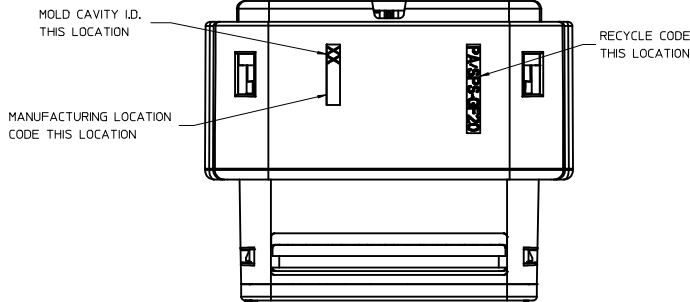
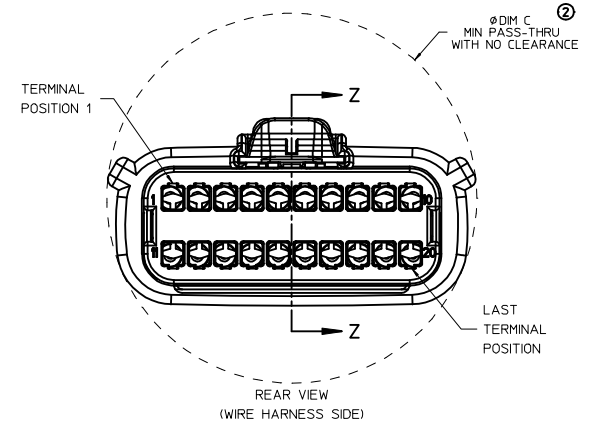
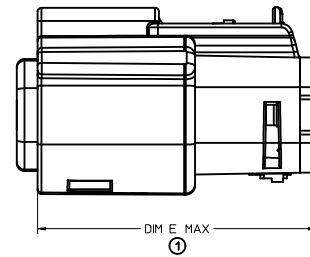
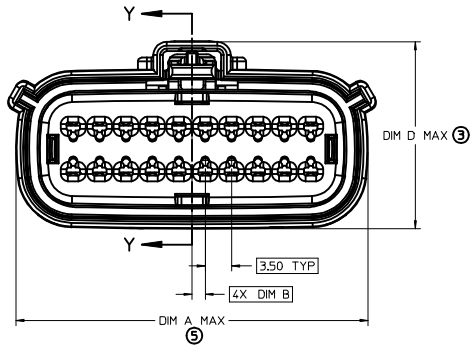
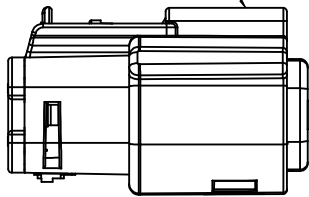

PRIMARY LOCK REINFORCEMENT (PLR) SHOWN  
IN PRE-STAGED POSITION  
SECTION Y-Y

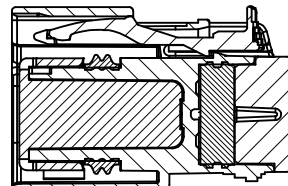

PRIMARY LOCK REINFORCEMENT (PLR) SHOWN  
IN FINAL-LOCK POSITION  
SECTION Z-Z

<b>ENTER DESCRIPTION</b> LEC NO: UAU2015-1759 DRWN:APROFF ITT 2015/05/22 CHKD:KABORUSZENSK 2015/06/03 APPR:VKOSHY 2015/06/04 A4	<b>QUALITY SYMBOLS</b> ∇=0 ∇=0 ∇=0	<b>GENERAL TOLERANCES (UNLESS SPECIFIED)</b>		<b>DIMENSION STYLE</b> MM ONLY		SCALE 3:1	DESIGN UNITS METRIC	THIRD ANGLE PROJECTION	
		4 PLACES ± --- ± --- 3 PLACES ± --- ± --- 2 PLACES ± 0.10 ± --- 1 PLACE ± 0.2 ± --- 0 PLACE ± --- ± ---	mm INCH	DRAWN BY APROFF ITT	DATE 2014/05/14	TITLE MX150 RCPT DUAL ROW SEALED ASSEMBLY MAT SEAL			
		ANGULAR ± 1 ° DRAFT WHERE APPLICABLE MUST REMAIN WITHIN DIMENSIONS		CHECKED BY	DATE	APPROVED BY VKOSHY			
		MATERIAL NO. SEE NOTE 2a.		DATE 2014/06/27		DOCUMENT NO. SD-33472-0001		SHEET NO. 5 OF 8	

**SHEET DESCRIPTION**  
BACKSHELL NOTES

BACKSHELL NOTES: VALID UNLESS OTHERWISE SPECIFIED

1. GENERAL:  
 a. APPLICATION SPECIFICATION SEE: AS-34951-001  
 -DESIGNED TO MATE WITH RECEPTACLE SEALED ASSEMBLY SPECIFIED IN MOLEX DRAWING SD-33472-0001.  
 -SYSTEM TO BE USED WITH WIRE WITHIN DIAMETER RANGE OF 1.2mm TO 2.69mm.  
 -COMPONENTS ARE OPTIONAL AND MUST BE PURCHASED SEPERATELY.  
 -BACKSHELL DESIGN IS OWNED BY SCHLEMMER.  
 -FOR ADDITIONAL INFORMATION SEE THE BACKSHELL COMPONENT DRAWING SD-34951-0001.

BACKSHELL CUSTOMER MODEL NUMBER LEGEND

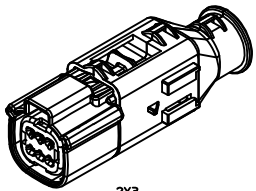
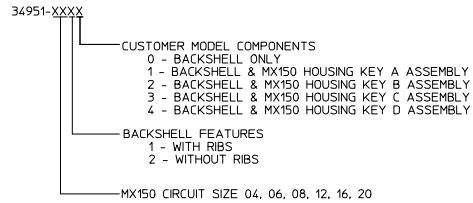

2X3

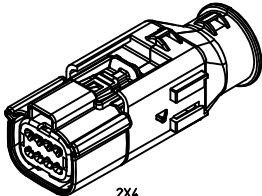

2X4

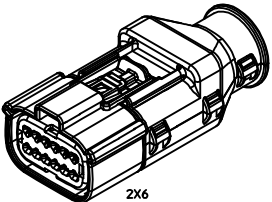

2X6

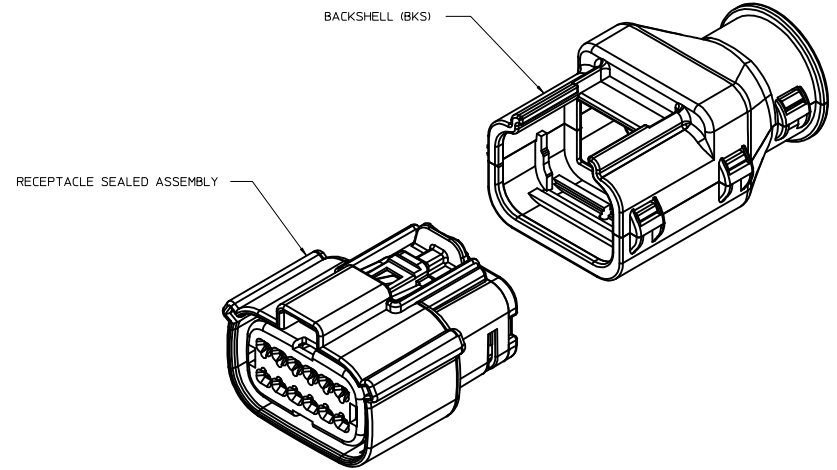

ENTER DESCRIPTION ELEC NO: UA02015-759 DRAWN BY: APROFFITT 2015/05/22 CHKD BY: KORUSZEWSKI 2015/06/03 APPR: WKOSHY 2015/06/04	QUALITY SYMBOLS ▽=0 ▽=0 ▽=0	GENERAL TOLERANCES (UNLESS SPECIFIED)		DIMENSION STYLE <b>MM ONLY</b>		SCALE 4:1	DESIGN UNITS METRIC	THIRD ANGLE PROJECTION	
		4 PLACES ± --- ± ---	3 PLACES ± --- ± ---	2 PLACES ± 0.10 ± ---	1 PLACE ± 0.2 ± ---	0 PLACE ± --- ± ---	DRAWN BY DATE APROFFITT 2014/05/14		TITLE MX150 RCPT DUAL ROW SEALED ASSEMBLY MAT SEAL
		ANGULAR ± 1 °		DRAFT WHERE APPLICABLE MUST REMAIN WITHIN DIMENSIONS		APPROVED BY DATE WKOSHY 2014/06/27		MATERIAL NO.	
		SEE NOTE 2a.		DOCUMENT NO. SD-33472-0001		SHEET NO. 6 OF 8			

**SHEET DESCRIPTION**

BACKSHELL

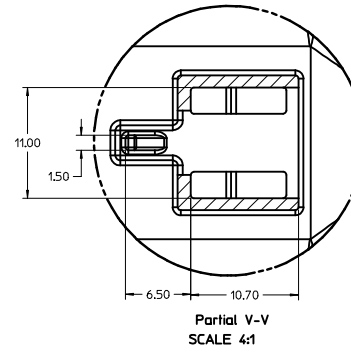
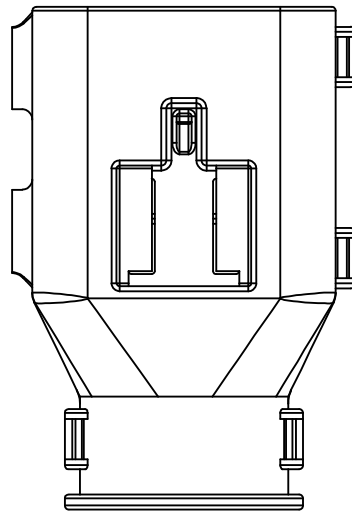
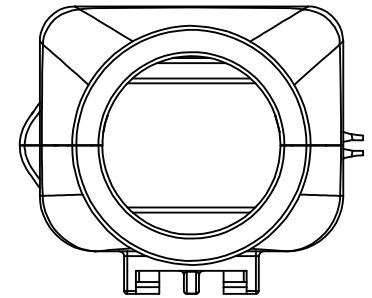
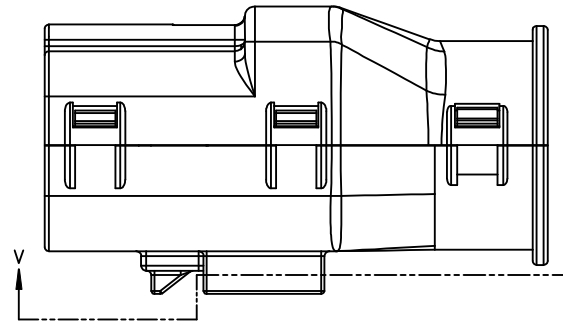
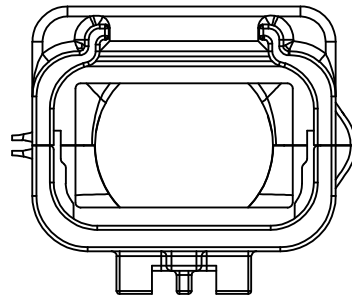
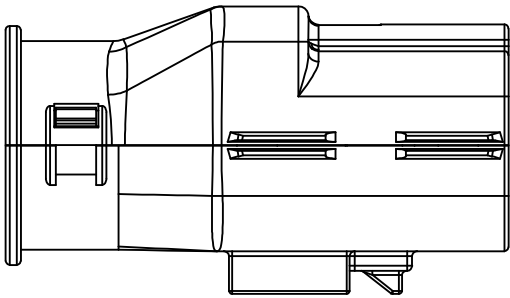

<b>ENTER DESCRIPTION</b> ELEC NO: UA02015-1759 DRAWN BY: APFOFFITT 2015/05/22 CHKD BY: BORUSZENSK 2015/06/03 APPR: VKOSHY 2015/06/04	QUALITY SYMBOLS ∇=0 ∇=1 ∇=2 ∇=3	GENERAL TOLERANCES (UNLESS SPECIFIED)		DIMENSION STYLE <b>MM ONLY</b>		SCALE <b>4:1</b>	DESIGN UNITS <b>METRIC</b>	THIRD ANGLE PROJECTION
		4 PLACES ± --- ± --- 3 PLACES ± --- ± --- 2 PLACES ± 0.10 ± --- 1 PLACE ± 0.2 ± --- 0 PLACE ± --- ± ---	mm INCH	DRAWN BY DATE APFOFFITT 2014/05/14 CHECKED BY DATE	TITLE <b>MX150 RCPT                  DUAL ROW SEALED ASSEMBLY                  MAT SEAL</b>		DOCUMENT NO. <b>SD-33472-0001</b>	SHEET NO. <b>7 OF 8</b>
		ANGULAR ± 1 °		APPROVED BY DATE VKOSHY 2014/06/27		MATERIAL NO.		SEE NOTE 2a.
		DRAFT WHERE APPLICABLE MUST REMAIN WITHIN DIMENSIONS		SIZE 1		THIS DRAWING CONTAINS INFORMATION THAT IS PROPRIETARY TO MOLEX INCORPORATED AND SHOULD NOT BE USED WITHOUT WRITTEN PERMISSION		



**SHEET DESCRIPTION**  
BACKSHELL CONFIGURATIONS

CHARTED DIMENSIONS	
DESCRIPTION	DIMENSIONS
2X2 STANDARD	H
2X2 LENGTHENED	TBD
2X3 W/ CLIPSLOT	TBD
2X3 W/O CLIPSLOT	28,50
2X4 W/ CLIPSLOT	TBD
2X4 W/O CLIPSLOT	30,75
2X6 W/ CLIPSLOT	TBD
2X6 W/O CLIPSLOT	35,83
2X8 W/O CLIPSLOT	TBD
2X10 W/O CLIPSLOT	TBD

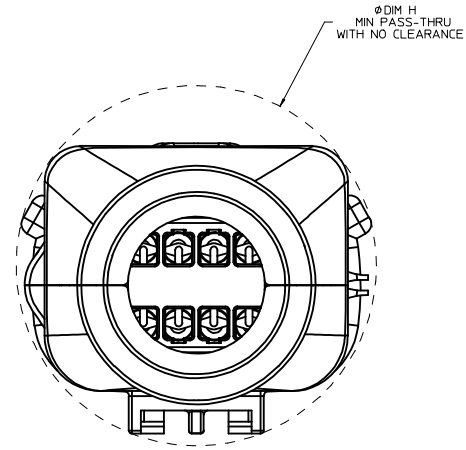
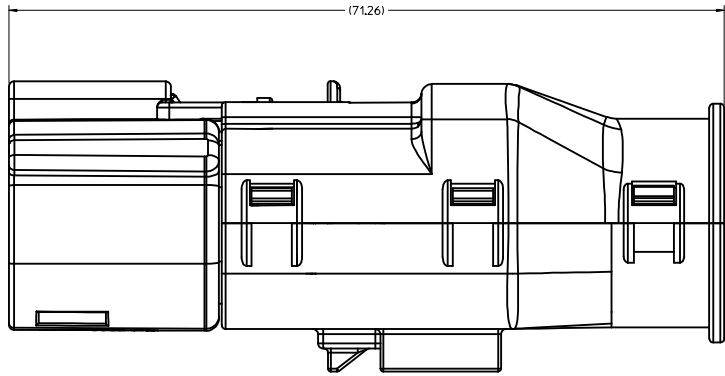

RECEPTACLE SEALED ASSEMBLY WITH RECEPTACLE BACKSHELL

<b>ENTER DESCRIPTION</b> EEC NO: UAU2015-1759 DRAWN BY: APROFFITT 2015/05/22 CHKD BY: BORUSZENSK 2015/06/03 APPR: VKOSHY 2015/06/04	<b>QUALITY SYMBOLS</b> ∇=0 ∇=0 ∇=0	<b>GENERAL TOLERANCES (UNLESS SPECIFIED)</b>		<b>DIMENSION STYLE</b> <b>MM ONLY</b>		<b>SCALE</b> 4:1	<b>DESIGN UNITS</b> METRIC	THIRD ANGLE PROJECTION	
		4 PLACES ± --- ± --- 3 PLACES ± --- ± --- 2 PLACES ± 0.10 ± --- 1 PLACE ± 0.2 ± --- 0 PLACE ± --- ± ---	mm    INCH	DRAWN BY: APROFFITT    DATE: 2014/05/14 CHECKED BY:    DATE:	<b>TITLE</b> MX150 RCPT DUAL ROW SEALED ASSEMBLY MAT SEAL			DOCUMENT NO. SD-33472-0001	SHEET NO. 8 OF 8
		ANGULAR ± 1 °		APPROVED BY: VKOSHY    DATE: 2014/06/27	<b>SEE NOTE 2a.</b>				
		DRAFT WHERE APPLICABLE MUST REMAIN WITHIN DIMENSIONS		MATERIAL NO.	THIS DRAWING CONTAINS INFORMATION THAT IS PROPRIETARY TO MOLEX INCORPORATED AND SHOULD NOT BE USED WITHOUT WRITTEN PERMISSION				
SIZE 1		SIZE 1							



**MX150 RECEPTACLE 2X2 SEALED ASSEMBLY MAT SEAL  
BOM AND PIN OUT SHEET**

ASSEMBLY DESCRIPTION	ASSEMBLY PART NUMBER	COMPONENT						BLOCKED TERMINALS										STATUS	COMMENTS	OPTIONAL ATTATCHMENTS SOLD SEPERATELY		
		THE PRESENCE OF AN ABBREVIATION INDICATES THE PRESENCE OF THAT COMPONENT.						CAVITY WITH A NUMBER INDICATES BLOCKED TERMINAL POSITION CAVITY WITHOUT A NUMBER INDICATES OPEN TERMINAL POSITION												BACKSHELL WITH RIBS	BACKSHELL WITHOUT RIBS	
		HOUSING KEY/COLOR	GROMMET CAP	PLR	CPA	MAT SEAL	RING SEAL	1	2	3	4											
KEY A, BLACK, W/O CPA	33472-4052	A-BLK	GCP	PLR		M	R		2		4									NOT VALIDATED		
KEY A, YELLOW, W/CPA	33472-4053	A-YW	GCO	PLR	CPA	M	R													NOT VALIDATED		
KEY A, BLACK, W/O CPA	33472-4054	A-BLK	GCP	PLR		M	R	1		3										NOT VALIDATED		
KEY B, LIGHT GRAY, W/CPA	33472-4055	B-LG	GCP	PLR	CPA	M	R	1												NOT VALIDATED		
KEY A, BLACK, W/O CPA	33472-4056	A-BLK	GCP	PLR		M	R	1												NOT VALIDATED		

MX150 RECEPTACLE 2X3 SEALED ASSEMBLY MAT SEAL  
BOM AND PIN OUT SHEET

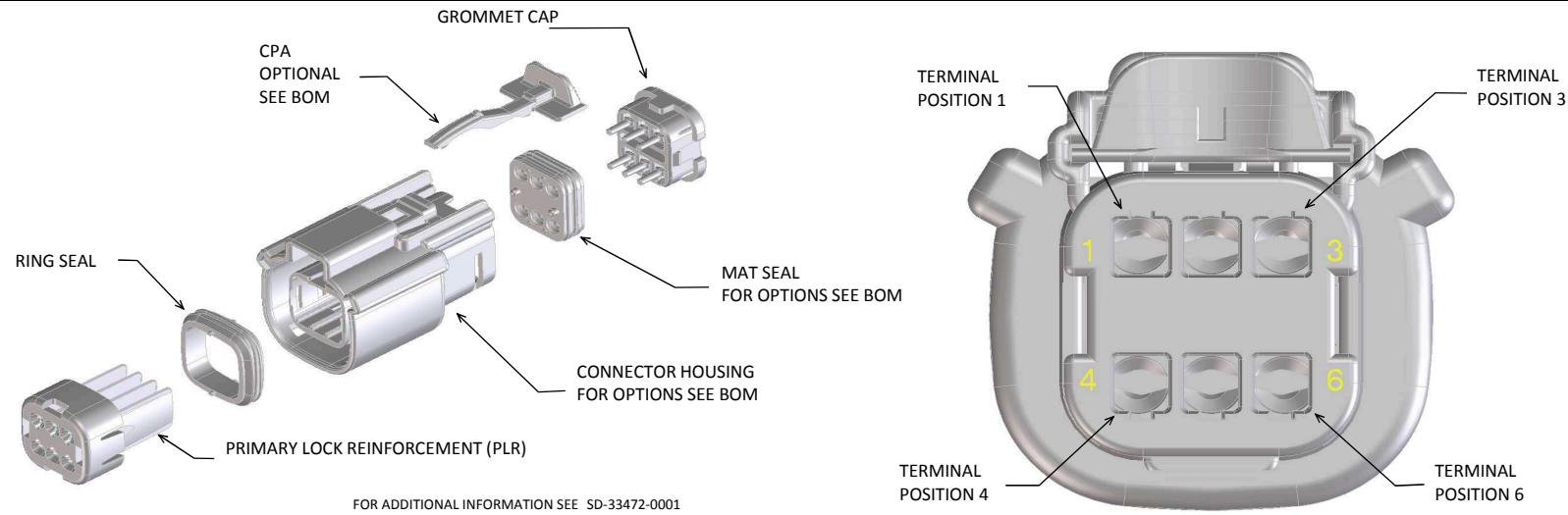

ABBREVIATION	DESCRIPTION	COLOR	MATERIAL
A-BLK	HOUSING, KEYING OPTION A	BLACK	SPS/NYLON GF20
B-LG	HOUSING, KEYING OPTION B	LIGHT GRAY	SPS/NYLON GF20
C-BR	HOUSING, KEYING OPTION C	BROWN	SPS/NYLON GF20
D-GR	HOUSING, KEYING OPTION D	GREEN	SPS/NYLON GF20
C-DG	HOUSING, KEYING OPTION C	DARK GRAY	SPS/NYLON GF20
D-SG	HOUSING, KEYING OPTION D	STONE GRAY	SPS/NYLON GF20
A-YW	HOUSING, KEYING OPTION A	YELLOW	SPS/NYLON GF20
A-BLK-CLIP	HOUSING, KEYING OPTION A WITH CLIPSLOT	BLACK	SPS/NYLON GF20
B-LG-CLIP	HOUSING, KEYING OPTION B WITH CLIPSLOT	LIGHT GRAY	SPS/NYLON GF20
C-BR-CLIP	HOUSING, KEYING OPTION C WITH CLIPSLOT	BROWN	SPS/NYLON GF20
D-GR-CLIP	HOUSING, KEYING OPTION D WITH CLIPSLOT	GREEN	SPS/NYLON GF20
C-DG-CLIP	HOUSING, KEYING OPTION C WITH CLIPSLOT	DARK GRAY	SPS/NYLON GF20
D-SG-CLIP	HOUSING, KEYING OPTION D WITH CLIPSLOT	STONE GRAY	SPS/NYLON GF20
A-SG-CLIP	HOUSING, KEYING OPTION A WITH CLIPSLOT	YELLOW	SPS/NYLON GF20
GC	GROMMET CAP	BLACK	SPS/NYLON GF20
PLR	PLR	NATURAL	SPS/NYLON GF20
CPA	CPA	RED	PBT GF20
M	MAT SEAL	LIGHT BLUE	INHERENTLY LUBRICATED SILICONE
R	RING SEAL	RUST RED	INHERENTLY LUBRICATED SILICONE

ASSEMBLY DESCRIPTION	ASSEMBLY PART NUMBER	COMPONENT							BLOCKED TERMINALS						STATUS	COMMENTS	OPTIONAL ATTACHMENTS SOLD SEPERATELY		
		THE PRESENCE OF AN ABBREVIATION INDICATES THE PRESENCE OF THAT COMPONENT.							CAVITY WITH A NUMBER INDICATES BLOCKED TERMINAL POSITION CAVITY WITHOUT A NUMBER INDICATES OPEN TERMINAL POSITION								BACKSHELL WITH RIBS	BACKSHELL WITHOUT RIBS	
		HOUSING KEY/COLOR	GROMMET CAP	PLR	CPA	MAT SEAL	RING SEAL	1	2	3	4	5	6						
KEY A, BLACK, W/O CPA	33472-0601	A-BLK	GC	PLR		M	R									SALEABLE		34951-0610	34951-0620
KEY B, LIGHT GRAY, W/O CPA	33472-0602	B-LG	GC	PLR		M	R											34951-0610	34951-0620
KEY C, BROWN, W/O CPA	33472-0603	C-BR	GC	PLR		M	R									NOT RECOMMENDED	SEE P/N 33472-0669	34951-0610	34951-0620
KEY D, GREEN, W/O CPA	33472-0604	D-GR	GC	PLR		M	R									NOT RECOMMENDED	SEE P/N 33472-0668	34951-0610	34951-0620
VOID KEY	33472-0605																		
KEY A, BLACK, W/CPA	33472-0606	A-BLK	GC	PLR	CPA	M	R									SALEABLE		34951-0610	34951-0620
KEY B, LIGHT GRAY, W/CPA	33472-0607	B-LG	GC	PLR	CPA	M	R											34951-0610	34951-0620
KEY C, BROWN, W/CPA	33472-0608	C-BR	GC	PLR	CPA	M	R									NOT RECOMMENDED	SEE P/N 33472-0670	34951-0610	34951-0620
KEY D, GREEN, W/CPA	33472-0609	D-GR	GC	PLR	CPA	M	R									NOT RECOMMENDED	SEE P/N 33472-0671	34951-0610	34951-0620
VOID KEY	33472-0610																		
KEY A, BLACK, W/O CPA	33472-0611	A-BLK	GC	PLR		M	R			3						SALEABLE	SAME AS P/N 33472-0658	34951-0610	34951-0620
KEY B, LIGHT GRAY, W/O CPA	33472-0612	B-LG	GC	PLR		M	R			3								34951-0610	34951-0620
KEY C, BROWN, W/O CPA	33472-0613	C-BR	GC	PLR		M	R			3						NOT RECOMMENDED		34951-0610	34951-0620
KEY D, GREEN, W/O CPA	33472-0614	D-GR	GC	PLR		M	R			3						NOT RECOMMENDED		34951-0610	34951-0620
VOID KEY	33472-0615																		
KEY A, BLACK, W/CPA	33472-0616	A-BLK	GC	PLR	CPA	M	R			3						SALEABLE		34951-0610	34951-0620
KEY B, LIGHT GRAY, W/CPA	33472-0617	B-LG	GC	PLR	CPA	M	R			3								34951-0610	34951-0620
KEY C, BROWN, W/CPA	33472-0618	C-BR	GC	PLR	CPA	M	R			3						NOT RECOMMENDED		34951-0610	34951-0620
KEY D, GREEN, W/CPA	33472-0619	D-GR	GC	PLR	CPA	M	R			3						NOT RECOMMENDED		34951-0610	34951-0620
VOID KEY	33472-0620																		
KEY A, BLACK, W/O CPA	33472-0621	A-BLK	GC	PLR		M	R			3	4					SALEABLE		34951-0610	34951-0620
KEY B, LIGHT GRAY, W/O CPA	33472-0622	B-LG	GC	PLR		M	R			3	4							34951-0610	34951-0620
KEY C, BROWN, W/O CPA	33472-0623	C-BR	GC	PLR		M	R			3	4					NOT RECOMMENDED		34951-0610	34951-0620
KEY D, GREEN, W/O CPA	33472-0624	D-GR	GC	PLR		M	R			3	4					NOT RECOMMENDED		34951-0610	34951-0620
VOID KEY	33472-0625																		
KEY A, BLACK, W/CPA	33472-0626	A-BLK	GC	PLR	CPA	M	R			3	4					SALEABLE		34951-0610	34951-0620
KEY B, LIGHT GRAY, W/CPA	33472-0627	B-LG	GC	PLR	CPA	M	R			3	4							34951-0610	34951-0620
KEY C, BROWN, W/CPA	33472-0628	C-BR	GC	PLR	CPA	M	R			3	4					NOT RECOMMENDED		34951-0610	34951-0620
KEY D, GREEN, W/CPA	33472-0629	D-GR	GC	PLR	CPA	M	R			3	4					NOT RECOMMENDED		34951-0610	34951-0620
VOID KEY	33472-0630																		
KEY A, BLACK, W/O CPA, W/O MAT SEAL	33472-0631	A-BLK	GC	PLR			R										NOT VALIDATED	34951-0610	34951-0620
KEY B, LIGHT GRAY, W/O CPA, W/O MAT SEAL	33472-0632	B-LG	GC	PLR			R										NOT VALIDATED	34951-0610	34951-0620
KEY C, BROWN, W/O CPA, W/O MAT SEAL	33472-0633	C-BR	GC	PLR			R									NOT RECOMMENDED	NOT VALIDATED	34951-0610	34951-0620
KEY D, GREEN, W/O CPA, W/O MAT SEAL	33472-0634	D-GR	GC	PLR			R									NOT RECOMMENDED	NOT VALIDATED	34951-0610	34951-0620
VOID KEY	33472-0635																		
KEY A, BLACK, W/O CPA	33472-0636	A-BLK	GC	PLR		M	R	1	2	3	4	5	6			SALEABLE		34951-0610	34951-0620
KEY B, LIGHT GRAY, W/O CPA	33472-0637	B-LG	GC	PLR		M	R	1	2	3	4	5	6					34951-0610	34951-0620
KEY C, BROWN, W/O CPA	33472-0638	C-BR	GC	PLR		M	R	1	2	3	4	5	6			NOT RECOMMENDED		34951-0610	34951-0620
KEY D, GREEN, W/O CPA	33472-0639	D-GR	GC	PLR		M	R	1	2	3	4	5	6			NOT RECOMMENDED		34951-0610	34951-0620
VOID KEY	33472-0640																		
KEY A, BLACK, W/O CPA	33472-0641	A-BLK	GC	PLR		M	R		2	3	4	5				SALEABLE		34951-0610	34951-0620
KEY A, BLACK, W/CPA	33472-0642	A-BLK	GC	PLR		M	R				4					SALEABLE		34951-0610	34951-0620
KEY A, BLACK, W/CPA	33472-0643	A-BLK	GC	PLR	CPA	M	R	1		3	4					SALEABLE		34951-0610	34951-0620
KEY B, LIGHT GRAY, W/CPA	33472-0644	B-LG	GC	PLR	CPA	M	R	1		3	4							34951-0610	34951-0620
KEY C, BROWN, W/CPA	33472-0645	C-BR	GC	PLR	CPA	M	R	1		3	4					NOT RECOMMENDED		34951-0610	34951-0620
KEY D, GREEN, W/CPA	33472-0646	D-GR	GC	PLR	CPA	M	R	1		3	4					NOT RECOMMENDED		34951-0610	34951-0620
VOID KEY	33472-0647																		
KEY A, BLACK, W/O CPA	33472-0648	A-BLK	GC	PLR		M	R	1		3	4			6		SALEABLE		34951-0610	34951-0620
KEY B, LIGHT GRAY, W/O CPA	33472-0649	B-LG	GC	PLR		M	R	1		3	4			6				34951-0610	34951-0620
KEY C, BROWN, W/O CPA	33472-0650	C-BR	GC	PLR		M	R	1		3	4			6		NOT RECOMMENDED		34951-0610	34951-0620
KEY D, GREEN, W/O CPA	33472-0651	D-GR	GC	PLR		M	R	1		3	4			6		NOT RECOMMENDED		34951-0610	34951-0620
VOID KEY	33472-0652																		
KEY A, BLACK, W/CPA	33472-0653	A-BLK	GC	PLR	CPA	M	R	1		3	4			6		SALEABLE		34951-0610	34951-0620
KEY B, LIGHT GRAY, W/CPA	33472-0654	B-LG	GC	PLR	CPA	M	R	1		3	4			6				34951-0610	34951-0620
KEY C, BROWN, W/CPA	33472-0655	C-BR	GC	PLR	CPA	M	R	1		3	4			6		NOT RECOMMENDED		34951-0610	34951-0620
KEY D, GREEN, W/CPA	33472-0656	D-GR	GC	PLR	CPA	M	R	1		3	4			6		NOT RECOMMENDED		34951-0610	34951-0620

MX150 RECEPTACLE 2X3 SEALED ASSEMBLY MAT SEAL  
BOM AND PIN OUT SHEET

ASSEMBLY DESCRIPTION	ASSEMBLY PART NUMBER	COMPONENT						BLOCKED TERMINALS						STATUS	COMMENTS	OPTIONAL ATTACHMENTS SOLD SEPERATELY		
		THE PRESENCE OF AN ABBREVIATION INDICATES THE PRESENCE OF THAT COMPONENT.						CAVITY WITH A NUMBER INDICATES BLOCKED TERMINAL POSITION CAVITY WITHOUT A NUMBER INDICATES OPEN TERMINAL POSITION								BACKSHELL WITH RIBS	BACKSHELL WITHOUT RIBS	
		HOUSING KEY/COLOR	GROMMET CAP	PLR	CPA	MAT SEAL	RING SEAL	1	2	3	4	5	6					
VOID KEY	33472-0657																	
KEY A, BLACK, W/O CPA	33472-0658	A-BLK	GC	PLR		M	R			3				SALEABLE		34951-0610	34951-0620	
KEY A, BLACK, W/O CPA	33472-0659	A-BLK	GC	PLR		M	R			3				SALEABLE		34951-0610	34951-0620	
KEY A, BLACK, W/CPA	33472-0660	A-BLK	GC	PLR	CPA	M	R	1	2	3	4		5	6	SALEABLE		34951-0610	34951-0620
KEY A, BLACK, W/O CPA	33472-0661	A-BLK	GC	PLR		M	R		2					SALEABLE		34951-0610	34951-0620	
KEY A, BLACK, W/O CPA	33472-0662	A-BLK	GC	PLR		M	R		2				5		SALEABLE		34951-0610	34951-0620
KEY A, BLACK, W/O CPA	33472-0663	A-BLK	GC	PLR		M	R						5	6	SALEABLE		34951-0610	34951-0620
KEY A, BLACK, W/O CPA	33472-0664	A-BLK	GC	PLR		M	R				4		5	6	SALEABLE		34951-0610	34951-0620
KEY A, BLACK, W/O CPA	33472-0665	A-BLK	GC	PLR		M	R	1							SALEABLE		34951-0610	34951-0620
KEY A, BLACK, W/O CPA	33472-0666	A-BLK	GC	PLR		M	R		2				5	6	SALEABLE		34951-0610	34951-0620
KEY A, BLACK, W/O CPA	33472-0667	A-BLK	GC	PLR		M	R	1		3			5	6	SALEABLE		34951-0610	34951-0620
KEY C, DARK GRAY, W/O CPA	33472-0668	C-DG	GC	PLR		M	R								SALEABLE		34951-0610	34951-0620
KEY D, STONE GRAY, W/O CPA	33472-0669	D-SG	GC	PLR		M	R								SALEABLE		34951-0610	34951-0620
KEY C, DARK GRAY, W/CPA	33472-0670	C-DG	GC	PLR	CPA	M	R								SALEABLE		34951-0610	34951-0620
KEY D, STONE GRAY, W/CPA	33472-0671	D-SG	GC	PLR	CPA	M	R								SALEABLE		34951-0610	34951-0620
KEY B, LIGHT GRAY, W/O CPA	33472-0672	B-LG	GC	PLR		M	R						5		SALEABLE		34951-0610	34951-0620
KEY A, BLACK, W/O CPA	33472-0673	A-BLK	GC	PLR		M	R							6	SALEABLE		34951-0610	34951-0620
KEY A, BLACK, W/CPA	33472-0674	A-BLK	GC	PLR	CPA	M	R						5	6	SALEABLE		34951-0610	34951-0620
KEY A, BLACK, W/CPA	33472-0675	A-BLK	GC	PLR	CPA	M	R							6	SALEABLE		34951-0610	34951-0620
KEY B, LIGHT GRAY, W/CPA	33472-0676	B-LG	GC	PLR	CPA	M	R	1					5		SALEABLE		34951-0610	34951-0620
KEY B, LIGHT GRAY, W/O CPA	33472-0677	B-LG	GC	PLR		M	R	1					5		SALEABLE		34951-0610	34951-0620
KEY B, LIGHT GRAY, W/O CPA	33472-0678	B-LG	GC	PLR		M	R						5	6	SALEABLE		34951-0610	34951-0620
KEY A, BLACK, W/CPA	33472-0679	A-BLK	GC	PLR	CPA	M	R	1	2	3					SALEABLE		34951-0610	34951-0620
KEY A, BLACK, W/O CPA	33472-0680	A-BLK	GC	PLR		M	R	3	2	3					SALEABLE		34951-0610	34951-0620
KEY A, BLACK, W/CPA	33472-0681	A-BLK	GC	PLR	CPA	M	R		2						SALEABLE		34951-0610	34951-0620
KEY A, YELLOW, W/CPA	33472-0682	A-YW	GC	PLR	CPA	M	R								SALEABLE		34951-0610	34951-0620
KEY A, BLACK, W/O CPA	33472-0683	A-BLK	GC	PLR		M	R			3	4		5	6	SALEABLE		34951-0610	34951-0620
KEY A, BLACK, W/CPA	33472-0684	A-BLK	GC	PLR	CPA	M	R			2	3				SALEABLE		34951-0610	34951-0620
KEY B, LIGHT GRAY, W/CPA	33472-0685	B-LG	GC	PLR	CPA	M	R	1	2	3	4		5	6	SALEABLE		34951-0610	34951-0620
KEY B, LIGHT GRAY, W/CPA	33472-0686	B-LG	GC	PLR	CPA	M	R		2	3					SALEABLE		34951-0610	34951-0620
KEY A, BLACK, W/O CPA	33472-0687	A-BLK	GC	PLR		M	R	1		3	4				SALEABLE		34951-0610	34951-0620
KEY A, BLACK, W/CPA	33472-0688	A-BLK	GC	PLR	CPA	M	R				4		5	6	SALEABLE		34951-0610	34951-0620
KEY A, BLACK, W/CPA	33472-0689	A-BLK	GC	PLR	CPA	M	R				4				SALEABLE		34951-0610	34951-0620
KEY B, LIGHT GRAY, W/CPA	33472-0690	B-LG	GC	PLR	CPA	M	R				4				SALEABLE		34951-0610	34951-0620
KEY A, BLACK, W/CPA	33472-0691	A-BLK	GC	PLR	CPA	M	R	1		3			5		SALEABLE		34951-0610	34951-0620
KEY A, BLACK, W/CPA	33472-0692	A-BLK	GC	PLR	CPA	M	R		2		4			6	SALEABLE		34951-0610	34951-0620
KEY A, BLACK, WITH CLIPSLOT, W/O CPA	33472-0701	A-BLK-CLIP	GC	PLR		M	R								SALEABLE			
KEY B, LIGHT GRAY, WITH CLIPSLOT, W/O CPA	33472-0702	B-LG-CLIP	GC	PLR		M	R								TOOLED BUT NOT VALIDATED			
KEY C, BROWN, WITH CLIPSLOT, W/O CPA	33472-0703	C-BR-CLIP	GC	PLR		M	R								NOT RECOMMENDED--SEE P/N 33472-0714			
KEY D, GREEN, WITH CLIPSLOT, W/O CPA	33472-0704	D-GR-CLIP	GC	PLR		M	R								NOT RECOMMENDED--SEE P/N 33472-0715			
KEY A, BLACK, WITH CLIPSLOT, W/CPA	33472-0705	A-BLK-CLIP	GC	PLR	CPA	M	R								SALEABLE			
KEY B, LIGHT GRAY, WITH CLIPSLOT, W/CPA	33472-0706	B-LG-CLIP	GC	PLR	CPA	M	R								TOOLED BUT NOT VALIDATED			
KEY C, BROWN, WITH CLIPSLOT, W/CPA	33472-0707	C-BR-CLIP	GC	PLR	CPA	M	R								NOT RECOMMENDED--SEE P/N 33472-0716			
KEY D, GREEN, WITH CLIPSLOT, W/CPA	33472-0708	D-GR-CLIP	GC	PLR	CPA	M	R								NOT RECOMMENDED--SEE P/N 33472-0717			
KEY A, BLACK, WITH CLIPSLOT, W/O CPA	33472-0709	A-BLK-CLIP	GC	PLR		M	R			3					SALEABLE			
KEY A, BLACK, WITH CLIPSLOT, W/O CPA	33472-0710	A-BLK-CLIP	GC	PLR		M	R		2	3	4		5		SALEABLE			
KEY A, BLACK, WITH CLIPSLOT, W/O CPA	33472-0711	A-BLK-CLIP	GC	PLR		M	R						5	6	SALEABLE			
KEY A, BLACK, WITH CLIPSLOT, W/O CPA	33472-0712	A-BLK-CLIP	GC	PLR		M	R				3	4			SALEABLE			
KEY B, LIGHT GRAY, WITH CLIPSLOT, W/O CPA	33472-0713	B-LG-CLIP	GC	PLR		M	R	1					5		TOOLED BUT NOT VALIDATED			
KEY C, DARK GRAY, WITH CLIPSLOT, W/O CPA	33472-0714	C-DG-CLIP	GC	PLR		M	R								SALEABLE			
KEY D, STONE GRAY, WITH CLIPSLOT, W/O CPA	33472-0715	D-SG-CLIP	GC	PLR		M	R								SALEABLE			
KEY C, DARK GRAY, WITH CLIPSLOT, W/CPA	33472-0716	C-DG-CLIP	GC	PLR	CPA	M	R								SALEABLE			
KEY D, STONE GRAY, WITH CLIPSLOT, W/CPA	33472-0717	D-SG-CLIP	GC	PLR	CPA	M	R								SALEABLE			
KEY A, BLACK, WITH CLIPSLOT, W/O CPA	33472-0718	A-BLK-CLIP	GC	PLR		M	R			3				6	SALEABLE			
KEY B, LIGHT GRAY, WITH CLIPSLOT, W/CPA	33472-0719	B-LG-CLIP	GC	PLR	CPA	M	R	1					5		TOOLED BUT NOT VALIDATED			
KEY B, LIGHT GRAY, WITH CLIPSLOT, W/O CPA	33472-0720	B-LG-CLIP	GC	PLR		M	R						5		TOOLED BUT NOT VALIDATED			
KEY C, DARK GRAY, WITH CLIPSLOT, W/O CPA	33472-0721	C-DG-CLIP	GC	PLR		M	R			3					SALEABLE			
KEY A, BLACK, WITH CLIPSLOT, W/O CPA	33472-0722	A-BLK-CLIP	GC	PLR		M	R				4		5	6	SALEABLE			
KEY A, BLACK, WITH CLIPSLOT, W/O CPA	33472-0723	A-BLK-CLIP	GC	PLR		M	R		2	3			5	6	SALEABLE			
KEY A, BLACK, WITH CLIPSLOT, W/O CPA	33472-0724	A-BLK-CLIP	GC	PLR		M	R		2					6	SALEABLE			
KEY A, BLACK, WITH CLIPSLOT, W/O CPA	33472-0725	A-BLK-CLIP	GC	PLR		M	R			3			5	6	SALEABLE			
KEY A, BLACK, WITH CLIPSLOT, W/O CPA	33472-0726	A-BLK-CLIP	GC	PLR		M	R							6	SALEABLE			
KEY A, BLACK, WITH CLIPSLOT, W/O CPA	33472-0727	A-BLK-CLIP	GC	PLR		M	R							6	SALEABLE			
KEY A, BLACK, WITH CLIPSLOT, W/O CPA	33472-0728	A-BLK-CLIP	GC	PLR		M	R	1		2	3	4	5	6	SALEABLE			
KEY A, BLACK, WITH CLIPSLOT, W/O CPA	33472-0729	A-BLK-CLIP	GC	PLR		M	R	1	2	3	4		5	6	SALEABLE			
KEY A, BLACK, WITH CLIPSLOT, W/O CPA	33472-0730	A-BLK-CLIP	GC	PLR		M	R							6	SALEABLE			
KEY A, BLACK, WITH CLIPSLOT, W/O CPA	33472-0731	A-BLK-CLIP	GC	PLR		M	R							6	SALEABLE			
KEY B, LIGHT GRAY, WITH CLIPSLOT, W/O CPA	33472-0732	B-LG-CLIP	GC	PLR		M	R				4		5	6	SALEABLE		34951-0610	34951-0620

MX150 RECEPTACLE 2X6 SEALED ASSEMBLY MAT SEAL  
BOM AND PIN OUT SHEET

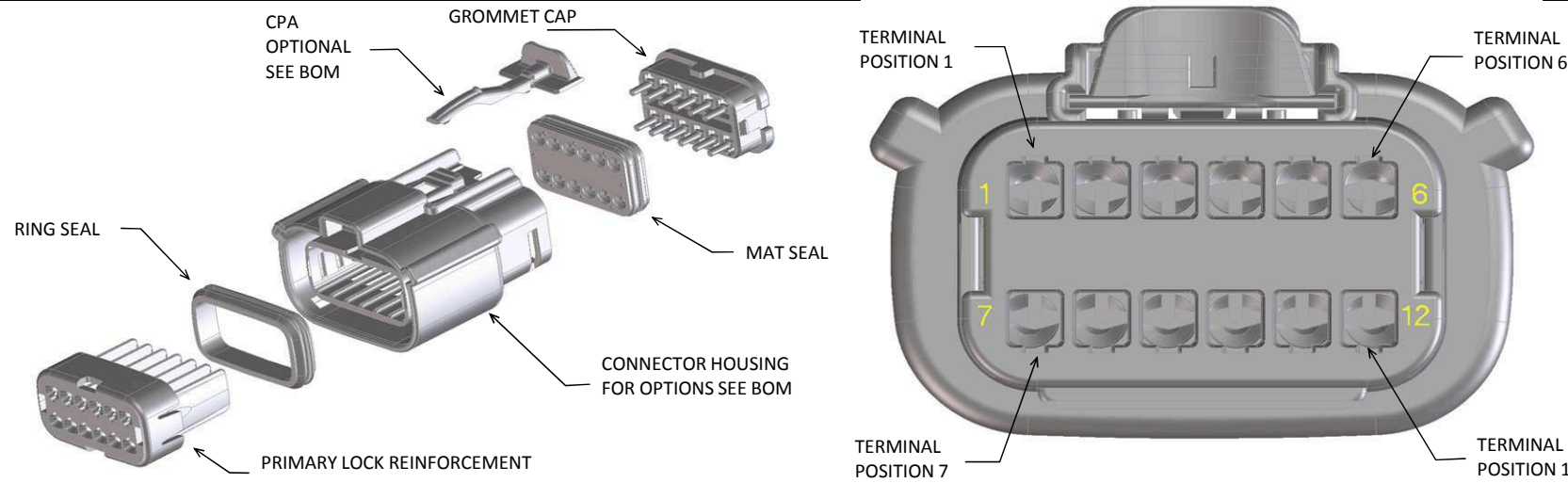

ABBREVIATION	DESCRIPTION	COLOR	MATERIAL
A-BLK	HOUSING, KEYING OPTION A	BLACK	SPS/NYLON GF20
B-LG	HOUSING, KEYING OPTION B	LIGHT GRAY	SPS/NYLON GF20
C-BR	HOUSING, KEYING OPTION C	BROWN	SPS/NYLON GF20
D-GR	HOUSING, KEYING OPTION D	GREEN	SPS/NYLON GF20
C-DG	HOUSING, KEYING OPTION C	DARK GRAY	SPS/NYLON GF20
D-SG	HOUSING, KEYING OPTION C	STONE GRAY	SPS/NYLON GF20
A-YW	HOUSING, KEYING OPTION A	YELLOW	SPS/NYLON GF20
A-BLK-CLIP	HOUSING, KEYING OPTION A WITH CLIPSLOT	BLACK	SPS/NYLON GF20
B-LG-CLIP	HOUSING, KEYING OPTION B WITH CLIPSLOT	LIGHT GRAY	SPS/NYLON GF20
C-BR-CLIP	HOUSING, KEYING OPTION C WITH CLIPSLOT	BROWN	SPS/NYLON GF20
D-GR-CLIP	HOUSING, KEYING OPTION D WITH CLIPSLOT	GREEN	SPS/NYLON GF20
C-DG-CLIP	HOUSING, KEYING OPTION C WITH CLIPSLOT	DARK GRAY	SPS/NYLON GF20
D-SG-CLIP	HOUSING, KEYING OPTION C WITH CLIPSLOT	STONE GRAY	SPS/NYLON GF20
GC	GROMMET CAP	BLACK	SPS/NYLON GF20
PLR	PLR	NATURAL	SPS/NYLON GF20
CPA	CPA	RED	PBT GF20
M	MAT SEAL	LIGHT BLUE	INHERENTLY LUBRICATED SILICONE
R	RING SEAL	GREEN	INHERENTLY LUBRICATED SILICONE

FOR ADDITIONAL INFORMATION SEE SD-33472-0001

ASSEMBLY DESCRIPTION	ASSEMBLY PART NUMBER	COMPONENT						BLOCKED TERMINALS												STATUS	COMMENTS	OPTIONAL ATTACHMENTS SOLD SEPERATELY						
		THE PRESENCE OF AN ABBREVIATION INDICATES THE PRESENCE OF THAT COMPONENT.							CAVITY WITH A NUMBER INDICATES BLOCKED TERMINAL POSITION CAVITY WITHOUT A NUMBER INDICATES OPEN TERMINAL POSITION													BACKSHELL WITH RIBS	BACKSHELL WITHOUT RIBS					
		HOUSING KEY/COLOR	GROMMET CAP	PLR	CPA	MAT SEAL	RING SEAL	1	2	3	4	5	6	7	8	9	10	11	12									
KEY A, BLACK, W/O CPA	33472-1201	A-BLK	GC	PLR		M	R																	SALEABLE		34951-1210	34951-1220	
KEY B, LIGHT GRAY, W/O CPA	33472-1202	B-LG	GC	PLR		M	R																		SALEABLE		34951-1210	34951-1220
KEY C, BROWN, W/O CPA	33472-1203	C-BR	GC	PLR		M	R																	NOT RECOMMENDED	SEE P/N 33472-1253	34951-1210	34951-1220	
KEY D, GREEN, W/O CPA	33472-1204	D-GR	GC	PLR		M	R																	NOT RECOMMENDED	SEE P/N 33472-1254	34951-1210	34951-1220	
VOID KEY	33472-1205																											
KEY A, BLACK, W/CPA	33472-1206	A-BLK	GC	PLR	CPA	M	R																	SALEABLE		34951-1210	34951-1220	
KEY B, LIGHT GRAY, W/CPA	33472-1207	B-LG	GC	PLR	CPA	M	R																	SALEABLE		34951-1210	34951-1220	
KEY C, BROWN, W/CPA	33472-1208	C-BR	GC	PLR	CPA	M	R																	NOT RECOMMENDED	SEE P/N 33472-1259	34951-1210	34951-1220	
KEY D, GREEN, W/CPA	33472-1209	D-GR	GC	PLR	CPA	M	R																	NOT RECOMMENDED	SEE P/N 33472-1260	34951-1210	34951-1220	
VOID KEY	33472-1210																											
KEY A, BLACK, W/O CPA	33472-1211	A-BLK	GC	PLR		M	R						6											SALEABLE		34951-1210	34951-1220	
KEY B, LIGHT GRAY, W/O CPA	33472-1212	B-LG	GC	PLR		M	R						6											SALEABLE		34951-1210	34951-1220	
KEY C, BROWN, W/O CPA	33472-1213	C-BR	GC	PLR		M	R						6											NOT RECOMMENDED		34951-1210	34951-1220	
KEY D, GREEN, W/O CPA	33472-1214	D-GR	GC	PLR		M	R						6											NOT RECOMMENDED		34951-1210	34951-1220	
VOID KEY	33472-1215																											
KEY A, BLACK, W/CPA	33472-1216	A-BLK	GC	PLR	CPA	M	R						6											SALEABLE		34951-1210	34951-1220	
KEY B, LIGHT GRAY, W/CPA	33472-1217	B-LG	GC	PLR	CPA	M	R						6											SALEABLE		34951-1210	34951-1220	
KEY C, BROWN, W/CPA	33472-1218	C-BR	GC	PLR	CPA	M	R						6											NOT RECOMMENDED		34951-1210	34951-1220	
KEY D, GREEN, W/CPA	33472-1219	D-GR	GC	PLR	CPA	M	R						6											NOT RECOMMENDED		34951-1210	34951-1220	
VOID KEY	33472-1220																											
KEY A, BLACK, W/O CPA	33472-1221	A-BLK	GC	PLR		M	R						6	7										SALEABLE		34951-1210	34951-1220	
KEY B, LIGHT GRAY, W/O CPA	33472-1222	B-LG	GC	PLR		M	R						6	7										SALEABLE		34951-1210	34951-1220	
KEY C, BROWN, W/O CPA	33472-1223	C-BR	GC	PLR		M	R						6	7										NOT RECOMMENDED		34951-1210	34951-1220	
KEY D, GREEN, W/O CPA	33472-1224	D-GR	GC	PLR		M	R						6	7										NOT RECOMMENDED		34951-1210	34951-1220	
VOID KEY	33472-1225																											
KEY A, BLACK, W/CPA	33472-1226	A-BLK	GC	PLR	CPA	M	R						6	7										SALEABLE		34951-1210	34951-1220	
KEY B, LIGHT GRAY, W/CPA	33472-1227	B-LG	GC	PLR	CPA	M	R						6	7										SALEABLE		34951-1210	34951-1220	
KEY C, BROWN, W/CPA	33472-1228	C-BR	GC	PLR	CPA	M	R						6	7										NOT RECOMMENDED		34951-1210	34951-1220	
KEY D, GREEN, W/CPA	33472-1229	D-GR	GC	PLR	CPA	M	R						6	7										NOT RECOMMENDED		34951-1210	34951-1220	
VOID KEY	33472-1230																											
KEY A, BLACK, W/O CPA	33472-1231	A-BLK	GC	PLR		M	R	1					6	7										SALEABLE		34951-1210	34951-1220	
KEY B, LIGHT GRAY, W/O CPA	33472-1232	B-LG	GC	PLR		M	R	1					6	7										SALEABLE		34951-1210	34951-1220	
KEY C, BROWN, W/O CPA	33472-1233	C-BR	GC	PLR		M	R	1					6	7										NOT RECOMMENDED		34951-1210	34951-1220	
KEY D, GREEN, W/O CPA	33472-1234	D-GR	GC	PLR		M	R	1					6	7										NOT RECOMMENDED		34951-1210	34951-1220	
VOID KEY	33472-1235																											
KEY A, BLACK, W/CPA	33472-1236	A-BLK	GC	PLR	CPA	M	R	1					6	7										SALEABLE		34951-1210	34951-1220	
KEY B, LIGHT GRAY, W/CPA	33472-1237	B-LG	GC	PLR	CPA	M	R	1					6	7										SALEABLE		34951-1210	34951-1220	
KEY C, BROWN, W/CPA	33472-1238	C-BR	GC	PLR	CPA	M	R	1					6	7										NOT RECOMMENDED		34951-1210	34951-1220	
KEY D, GREEN, W/CPA	33472-1239	D-GR	GC	PLR	CPA	M	R	1					6	7										NOT RECOMMENDED		34951-1210	34951-1220	
VOID KEY	33472-1240																											
KEY A, BLACK, W/O CPA	33472-1241	A-BLK	GC	PLR		M	R	1					6	7										SALEABLE		34951-1210	34951-1220	
KEY B, LIGHT GRAY, W/O CPA	33472-1242	B-LG	GC	PLR		M	R	1					6	7										SALEABLE		34951-1210	34951-1220	
KEY C, BROWN, W/O CPA	33472-1243	C-BR	GC	PLR		M	R	1					6	7										NOT RECOMMENDED		34951-1210	34951-1220	
KEY D, GREEN, W/O CPA	33472-1244	D-GR	GC	PLR		M	R	1					6	7										NOT RECOMMENDED		34951-1210	34951-1220	
VOID KEY	33472-1245																											
KEY A, BLACK, W/CPA	33472-1246	A-BLK	GC	PLR	CPA	M	R	1					6	7										SALEABLE		34951-1210	34951-1220	
KEY B, LIGHT GRAY, W/CPA	33472-1247	B-LG	GC	PLR	CPA	M	R	1					6	7										SALEABLE		34951-1210	34951-1220	
KEY C, BROWN, W/CPA	33472-1248	C-BR	GC	PLR	CPA	M	R	1					6	7										NOT RECOMMENDED		34951-1210	34951-1220	
KEY D, GREEN, W/CPA	33472-1249	D-GR	GC	PLR	CPA	M	R	1					6	7										NOT RECOMMENDED		34951-1210	34951-1220	
VOID KEY	33472-1250																											
KEY A, BLACK, W/O CPA	33472-1251	A-BLK	GC	PLR		M	R						6											SALEABLE		34951-1210	34951-1220	
KEY A, BLACK, W/CPA	33472-1252	A-BLK	GC	PLR	CPA	M	R																	SALEABLE		34951-1210	34951-1220	
KEY C, DARK GRAY, W/O CPA	33472-1253	C-DG	GC	PLR		M	R																	SALEABLE		34951-1210	34951-1220	
KEY D, STONE GRAY, W/O CPA	33472-1254	D-SG	GC	PLR		M	R																	SALEABLE		34951-1210	34951-1220	
KEY A, BLACK, W/CPA	33472-1255	A-BLK	GC	PLR	CPA	M	R																	SALEABLE		34951-1210	34951-1220	

MX150 RECEPTACLE 2X6 SEALED ASSEMBLY MAT SEAL  
BOM AND PIN OUT SHEET

ASSEMBLY DESCRIPTION	ASSEMBLY PART NUMBER	COMPONENT						BLOCKED TERMINALS												STATUS	COMMENTS	OPTIONAL ATTACHMENTS SOLD SEPERATELY	
		THE PRESENCE OF AN ABBREVIATION INDICATES THE PRESENCE OF THAT COMPONENT.						CAVITY WITH A NUMBER INDICATES BLOCKED TERMINAL POSITION CAVITY WITHOUT A NUMBER INDICATES OPEN TERMINAL POSITION														BACKSHELL WITH RIBS	BACKSHELL WITHOUT RIBS
		HOUSING KEY/COLOR	GROMMET CAP	PLR	CPA	MAT SEAL	RING SEAL	1	2	3	4	5	6	7	8	9	10	11	12				
KEY A, BLACK, W/CPA	33472-1256	A-BLK	GC	PLR	CPA	M	R								9	10	11	12	SALEABLE		34951-1210	34951-1220	
KEY A, BLACK, W/O CPA	33472-1257	A-BLK	GC	PLR		M	R							8		10	11	12	SALEABLE		34951-1210	34951-1220	
KEY A, BLACK, W/O CPA	33472-1258	A-BLK	GC	PLR		M	R	1	2	3	4	5	6	7	8	9	10	11	12	SALEABLE		34951-1210	34951-1220
KEY C, DARK GRAY, W/CPA	33472-1259	C-DG	GC	PLR	CPA	M	R												SALEABLE		34951-1210	34951-1220	
KEY D, STONE GRAY, W/CPA	33472-1260	D-SG	GC	PLR	CPA	M	R												SALEABLE		34951-1210	34951-1220	
KEY A, BLACK, W/O CPA	33472-1261	A-BLK	GC	PLR		M	R								9	10	11	12	SALEABLE		34951-1210	34951-1220	
KEY A, BLACK, W/CPA	33472-1262	A-BLK	GC	PLR	CPA	M	R							8	9	10	11	12	SALEABLE		34951-1210	34951-1220	
KEY B, LIGHT GRAY, W/CPA	33472-1263	B-LG	GC	PLR	CPA	M	R												SALEABLE		34951-1210	34951-1220	
KEY C, DARK GRAY, W/CPA	33472-1264	C-DG	GC	PLR	CPA	M	R										11	12	SALEABLE		34951-1210	34951-1220	
KEY D, STONE GRAY, W/CPA	33472-1265	D-SG	GC	PLR	CPA	M	R												SALEABLE		34951-1210	34951-1220	
KEY A, BLACK, W/CPA	33472-1266	A-BLK	GC	PLR	CPA	M	R										11	12	SALEABLE		34951-1210	34951-1220	
KEY D, STONE GRAY, W/CPA	33472-1267	D-SG	GC	PLR	CPA	M	R	1					6	7					SALEABLE		34951-1210	34951-1220	
KEY A, BLACK, W/CPA	33472-1268	A-BLK	GC	PLR	CPA	M	R	1						7					SALEABLE		34951-1210	34951-1220	
KEY A, BLACK, W/CPA	33472-1269	A-BLK	GC	PLR	CPA	M	R	1	2		4		6	7	8		10	11	12	SALEABLE		34951-1210	34951-1220
KEY A, BLACK, W/CPA	33472-1270	A-BLK	GC	PLR	CPA	M	R							7					SALEABLE		34951-1210	34951-1220	
KEY A, BLACK, W/CPA	33472-1271	A-BLK	GC	PLR	CPA	M	R				4		6				10	11	12	SALEABLE		34951-1210	34951-1220
KEY A, BLACK, W/CPA	33472-1272	A-BLK	GC	PLR	CPA	M	R						6			9	10	11	12	SALEABLE		34951-1210	34951-1220
KEY A, BLACK, W/O CPA	33472-1273	A-BLK	GC	PLR		M	R						6			9	10	11	12	SALEABLE		34951-1210	34951-1220
KEY A, BLACK, W/CPA	33472-1274	A-BLK	GC	PLR	CPA	M	R						6	6				11	12	SALEABLE		34951-1210	34951-1220
KEY A, BLACK, W/O CPA	33472-1275	A-BLK	GC	PLR		M	R	1	2	3	4	5	6		8				SALEABLE		34951-1210	34951-1220	
KEY A, BLACK, W/O CPA	33472-1276	A-BLK	GC	PLR		M	R	1					6						SALEABLE		34951-1210	34951-1220	
KEY A, BLACK, W/O CPA	33472-1277	A-BLK	GC	PLR		M	R	1						7					SALEABLE		34951-1210	34951-1220	
KEY B, LIGHT GRAY, W/CPA	33472-1278	B-LG	GC	PLR	CPA	M	R									10	11	12	SALEABLE		34951-1210	34951-1220	
KEY A, BLACK, W/O CPA	33472-1279	A-BLK	GC	PLR		M	R							7				11	SALEABLE		34951-1210	34951-1220	
KEY A, BLACK, W/O CPA	33472-1280	A-BLK	GC	PLR		M	R		2					7					SALEABLE		34951-1210	34951-1220	
KEY A, BLACK, W/O CPA	33472-1281	A-BLK	GC	PLR		M	R	1			4								SALEABLE		34951-1210	34951-1220	
KEY A, BLACK, W/CPA	33472-1282	A-BLK	GC	PLR	CPA	M	R	1	2				6	7	8				SALEABLE		34951-1210	34951-1220	
KEY A, BLACK, W/CPA	33472-1283	A-BLK	GC	PLR	CPA	M	R	1						7					SALEABLE		34951-1210	34951-1220	
KEY A, BLACK, W/CPA	33472-1284	A-BLK	GC	PLR	CPA	M	R	1	2	3	4	5	6		8				SALEABLE		34951-1210	34951-1220	
KEY A, BLACK, W/CPA	33472-1285	A-BLK	GC	PLR	CPA	M	R	1					6						SALEABLE		34951-1210	34951-1220	
KEY C, DARK GRAY, W/CPA	33472-1286	C-DG	GC	PLR	CPA	M	R	1					6	7					SALEABLE		34951-1210	34951-1220	
KEY A, BLACK, W/CPA	33472-1287	A-BLK	GC	PLR	CPA	M	R									10	11	12	SALEABLE		34951-1210	34951-1220	
KEY C, DARK GRAY, W/CPA	33472-1288	C-DG	GC	PLR	CPA	M	R												SALEABLE		34951-1210	34951-1220	
KEY C, DARK GRAY, W/CPA	33472-1289	C-DG	GC	PLR	CPA	M	R								9	10	11	12	SALEABLE		34951-1210	34951-1220	
KEY A, BLACK, W/CPA	33472-1290	A-BLK	GC	PLR	CPA	M	R								9				SALEABLE		34951-1210	34951-1220	
KEY A, BLACK, W/CPA	33472-1291	A-BLK	GC	PLR	CPA	M	R	1				5	6	7	8				SALEABLE		34951-1210	34951-1220	
KEY A, YELLOW, W/CPA	33472-1292	A-YW	GC	PLR	CPA	M	R												SALEABLE		34951-1210	34951-1220	
KEY A, BLACK, W/CPA	33472-1293	A-BLK	GC	PLR	CPA	M	R	1											SALEABLE		34951-1210	34951-1220	
KEY A, BLACK, W/CPA	33472-1294	A-BLK	GC	PLR	CPA	M	R				4			7	8				SALEABLE		34951-1210	34951-1220	
KEY D, STONE GRAY, W/CPA	33472-1295	D-SG	GC	PLR	CPA	M	R								8		10	11	12	SALEABLE		34951-1210	34951-1220
KEY A, BLACK, W/CPA	33472-1296	A-BLK	GC	PLR	CPA	M	R								8	9	10	11	12	SALEABLE		34951-1210	34951-1220
KEY A, BLACK, W/CPA	33472-1297	A-BLK	GC	PLR	CPA	M	R	1	2	3	4	5	6		9	10	11	12	SALEABLE		34951-1210	34951-1220	
KEY A, BLACK, WITH CLIPSLOT, W/O CPA	33472-1301	A-BLK-CLIP	GC	PLR		M	R												SALEABLE				
KEY B, LIGHT GRAY, WITH CLIPSLOT, W/O CPA	33472-1302	B-LG-CLIP	GC	PLR		M	R												SALEABLE				
KEY C, BROWN, WITH CLIPSLOT, W/O CPA	33472-1303	C-BR-CLIP	GC	PLR		M	R												NOT RECOMMENDED	SEE P/N 33472-1407			
KEY D, GREEN, WITH CLIPSLOT, W/O CPA	33472-1304	D-GR-CLIP	GC	PLR		M	R												NOT RECOMMENDED	SEE P/N 33472-1408			
VOID KEY	33472-1305																						
KEY A, BLACK, WITH CLIPSLOT, W/CPA	33472-1306	A-BLK-CLIP	GC	PLR	CPA	M	R												SALEABLE				
KEY B, LIGHT GRAY, WITH CLIPSLOT, W/CPA	33472-1307	B-LG-CLIP	GC	PLR	CPA	M	R												SALEABLE				
KEY C, BROWN, WITH CLIPSLOT, W/CPA	33472-1308	C-BR-CLIP	GC	PLR	CPA	M	R												NOT RECOMMENDED	SEE P/N 33472-1409			
KEY D, GREEN, WITH CLIPSLOT, W/CPA	33472-1309	D-GR-CLIP	GC	PLR	CPA	M	R												NOT RECOMMENDED	SEE P/N 33472-1410			
VOID KEY	33472-1310																						
KEY A, BLACK, WITH CLIPSLOT, W/O CPA	33472-1311	A-BLK-CLIP	GC	PLR		M	R	1	2	3	4	5	6	7	8	9	10	11	12	SALEABLE			
KEY B, LIGHT GRAY, WITH CLIPSLOT, W/O CPA	33472-1312	B-LG-CLIP	GC	PLR		M	R	1	2	3	4	5	6	7	8	9	10	11	12	SALEABLE			
KEY C, BROWN, WITH CLIPSLOT, W/O CPA	33472-1313	C-BR-CLIP	GC	PLR		M	R	1	2	3	4	5	6	7	8	9	10	11	12	NOT RECOMMENDED	SEE P/N 33472-1411		
KEY D, GREEN, WITH CLIPSLOT, W/O CPA	33472-1314	D-GR-CLIP	GC	PLR		M	R	1	2	3	4	5	6	7	8	9	10	11	12	NOT RECOMMENDED	SEE P/N 33472-1412		
VOID KEY	33472-1315																						
KEY A, BLACK, WITH CLIPSLOT, W/CPA	33472-1316	A-BLK-CLIP	GC	PLR	CPA	M	R	1	2	3	4	5	6	7	8	9	10	11	12	SALEABLE			
KEY B, LIGHT GRAY, WITH CLIPSLOT, W/CPA	33472-1317	B-LG-CLIP	GC	PLR	CPA	M	R	1	2	3	4	5	6	7	8	9	10	11	12	SALEABLE			
KEY C, BROWN, WITH CLIPSLOT, W/CPA	33472-1318	C-BR-CLIP	GC	PLR	CPA	M	R	1	2	3	4	5	6	7	8	9	10	11	12	NOT RECOMMENDED	SEE P/N 33472-1413		
KEY D, GREEN, WITH CLIPSLOT, W/CPA	33472-1319	D-GR-CLIP	GC	PLR	CPA	M	R	1	2	3	4	5	6	7	8	9	10	11	12	NOT RECOMMENDED	SEE P/N 33472-1414		
VOID KEY	33472-1320																						
KEY A, BLACK, WITH CLIPSLOT, W/O CPA	33472-1321	A-BLK-CLIP	GC	PLR		M	R		2	3				8				11	SALEABLE				
KEY A, BLACK, WITH CLIPSLOT, W/O CPA	33472-1322	A-BLK-CLIP	GC	PLR		M	R		2	3		5	6	7	8			11	SALEABLE				
KEY A, BLACK, WITH CLIPSLOT, W/O CPA	33472-1323	A-BLK-CLIP	GC	PLR		M	R						6	7					SALEABLE				
KEY A, BLACK, WITH CLIPSLOT, W/O CPA	33472-1324	A-BLK-CLIP	GC	PLR		M	R			2	3		6	7	8		10	11	SALEABLE				
KEY A, BLACK, WITH CLIPSLOT, W/O CPA	33472-1325	A-BLK-CLIP	GC	PLR		M	R	1				5	6	7	8				SALEABLE				
KEY B, LIGHT GRAY, WITH CLIPSLOT, W/O CPA	33472-1326	B-LG-CLIP	GC	PLR		M	R	1				5	6	7	8		9	10	SALEABLE				
KEY A, BLACK, WITH CLIPSLOT, W/O CPA	33472-1327	A-BLK-CLIP	GC	PLR		M	R			2									SALEABLE				
KEY B, LIGHT GRAY, WITH CLIPSLOT, W/O CPA	33472-1328	B-LG-CLIP	GC	PLR		M	R			2						9	10		SALEABLE				
KEY A, BLACK, WITH CLIPSLOT, W/O CPA	33472-1329	A-BLK-CLIP	GC	PLR		M	R			2	3				8	9	10	11	SALEABLE				
KEY A, BLACK, WITH CLIPSLOT, W/O CPA	33472-1330	A-BLK-CLIP	GC	PLR		M	R							7	8	9	10	11	SALEABLE				
KEY A, BLACK, WITH CLIPSLOT, W/O CPA	33472-1331	A-BLK-CLIP	GC	PLR		M	R							7	8				SALEABLE				
KEY A, BLACK, WITH CLIPSLOT, W/O CPA	33472-1332	A-BLK-CLIP	GC	PLR		M	R			2						9	10		SALEABLE				
KEY A, BLACK, WITH CLIPSLOT, W/O CPA	33472-1333	A-BLK-CLIP	GC	PLR		M	R																

MX150 RECEPTACLE 2X6 SEALED ASSEMBLY MAT SEAL  
BOM AND PIN OUT SHEET

ASSEMBLY DESCRIPTION	ASSEMBLY PART NUMBER	COMPONENT						BLOCKED TERMINALS												STATUS	COMMENTS	OPTIONAL ATTACHMENTS SOLD SEPARATELY									
		THE PRESENCE OF AN ABBREVIATION INDICATES THE PRESENCE OF THAT COMPONENT.						CAVITY WITH A NUMBER INDICATES BLOCKED TERMINAL POSITION CAVITY WITHOUT A NUMBER INDICATES OPEN TERMINAL POSITION														BACKSHELL WITH RIBS	BACKSHELL WITHOUT RIBS								
		HOUSING KEY/COLOR	GROMMET CAP	PLR	CPA	MAT SEAL	RING SEAL	1	2	3	4	5	6	7	8	9	10	11	12												
KEY A, BLACK, WITH CLIPSLOT, W/O CPA	33472-1341	A-BLK-CLIP	GC	PLR		M	R		2			4	5			8		10	11		SALEABLE										
KEY A, BLACK, WITH CLIPSLOT, W/O CPA	33472-1342	A-BLK-CLIP	GC	PLR		M	R				3	4					9		10			SALEABLE									
KEY A, BLACK, WITH CLIPSLOT, W/O CPA	33472-1343	A-BLK-CLIP	GC	PLR		M	R	1						6	7							SALEABLE									
KEY A, BLACK, WITH CLIPSLOT, W/O CPA	33472-1344	A-BLK-CLIP	GC	PLR		M	R													11			SALEABLE								
KEY A, BLACK, WITH CLIPSLOT, W/O CPA	33472-1345	A-BLK-CLIP	GC	PLR		M	R								7								SALEABLE								
KEY A, BLACK, WITH CLIPSLOT, W/O CPA	33472-1346	A-BLK-CLIP	GC	PLR		M	R		2	3	4	5						10	11	12			SALEABLE								
KEY A, BLACK, WITH CLIPSLOT, W/O CPA	33472-1347	A-BLK-CLIP	GC	PLR		M	R	1						6	7					9			SALEABLE								
KEY A, BLACK, WITH CLIPSLOT, W/O CPA	33472-1348	A-BLK-CLIP	GC	PLR		M	R		2	3	4	5	6	7	8			10	11	12			SALEABLE								
KEY A, BLACK, WITH CLIPSLOT, W/O CPA	33472-1349	A-BLK-CLIP	GC	PLR	CPA	M	R				3		5							11			SALEABLE								
KEY A, BLACK, WITH CLIPSLOT, W/O CPA	33472-1350	A-BLK-CLIP	GC	PLR		M	R		2	3										11			SALEABLE								
KEY A, BLACK, WITH CLIPSLOT, W/O CPA	33472-1351	A-BLK-CLIP	GC	PLR		M	R	1	2	3	4	5						9	10	11	12			SALEABLE							
KEY A, BLACK, WITH CLIPSLOT, W/O CPA	33472-1352	A-BLK-CLIP	GC	PLR		M	R													11	12			SALEABLE							
KEY A, BLACK, WITH CLIPSLOT, W/O CPA	33472-1353	A-BLK-CLIP	GC	PLR		M	R		2	3								9	10	11				SALEABLE							
KEY A, BLACK, WITH CLIPSLOT, W/O CPA	33472-1354	A-BLK-CLIP	GC	PLR		M	R	1	2	3	4	5				8	9	10	11	12				SALEABLE							
KEY A, BLACK, WITH CLIPSLOT, W/O CPA	33472-1355	A-BLK-CLIP	GC	PLR		M	R	1	2	3	4	5									12				SALEABLE						
KEY A, BLACK, WITH CLIPSLOT, W/O CPA	33472-1356	A-BLK-CLIP	GC	PLR		M	R				3	4	5											SALEABLE							
KEY A, BLACK, WITH CLIPSLOT, W/O CPA	33472-1357	A-BLK-CLIP	GC	PLR		M	R				3	4	5	6	7	8	9	10	11					SALEABLE							
KEY A, BLACK, WITH CLIPSLOT, W/O CPA	33472-1358	A-BLK-CLIP	GC	PLR		M	R		2	3						8	9	10	11	12				SALEABLE							
KEY A, BLACK, WITH CLIPSLOT, W/O CPA	33472-1359	A-BLK-CLIP	GC	PLR	CPA	M	R						5			8	9			11				SALEABLE							
KEY A, BLACK, WITH CLIPSLOT, W/O CPA	33472-1360	A-BLK-CLIP	GC	PLR		M	R		2	3						8	9							SALEABLE							
KEY A, BLACK, WITH CLIPSLOT, W/O CPA	33472-1361	A-BLK-CLIP	GC	PLR		M	R	1	2	3										11	12				SALEABLE						
KEY A, BLACK, WITH CLIPSLOT, W/O CPA	33472-1362	A-BLK-CLIP	GC	PLR		M	R	1	2	3	4			6		8			10	11	12				SALEABLE						
KEY A, BLACK, WITH CLIPSLOT, W/O CPA	33472-1363	A-BLK-CLIP	GC	PLR		M	R		2		4			6		8			10	11	12				SALEABLE						
KEY A, BLACK, WITH CLIPSLOT, W/O CPA	33472-1364	A-BLK-CLIP	GC	PLR		M	R														11	12				SALEABLE					
KEY A, BLACK, WITH CLIPSLOT, W/O CPA	33472-1365	A-BLK-CLIP	GC	PLR		M	R	1	2	3	4	5	6							9					SALEABLE						
KEY A, BLACK, WITH CLIPSLOT, W/O CPA	33472-1366	A-BLK-CLIP	GC	PLR		M	R						6							9					SALEABLE						
KEY A, BLACK, WITH CLIPSLOT, W/O CPA	33472-1367	A-BLK-CLIP	GC	PLR		M	R		2						7	8	9								SALEABLE						
KEY A, BLACK, WITH CLIPSLOT, W/O CPA	33472-1368	A-BLK-CLIP	GC	PLR		M	R				3	4	5	6	7										SALEABLE						
KEY A, BLACK, WITH CLIPSLOT, W/O CPA	33472-1369	A-BLK-CLIP	GC	PLR		M	R	1	2	3	4	5	6	7								12				SALEABLE					
KEY A, BLACK, WITH CLIPSLOT, W/O CPA	33472-1370	A-BLK-CLIP	GC	PLR		M	R	1	2	3	4	5			7	8	9	10	11						SALEABLE						
KEY A, BLACK, WITH CLIPSLOT, W/O CPA	33472-1371	A-BLK-CLIP	GC	PLR		M	R		2		4			6		8			10	11					SALEABLE						
KEY A, BLACK, WITH CLIPSLOT, W/O CPA	33472-1372	A-BLK-CLIP	GC	PLR		M	R									8									SALEABLE						
KEY A, BLACK, WITH CLIPSLOT, W/O CPA	33472-1373	A-BLK-CLIP	GC	PLR		M	R	1			3	4	5	6	7	8			10	11	12				SALEABLE						
KEY A, BLACK, WITH CLIPSLOT, W/O CPA	33472-1374	A-BLK-CLIP	GC	PLR		M	R							6				9	10	11	12				SALEABLE						
KEY A, BLACK, WITH CLIPSLOT, W/O CPA	33472-1375	A-BLK-CLIP	GC	PLR		M	R																		SALEABLE						
KEY A, BLACK, WITH CLIPSLOT, W/O CPA	33472-1376	A-BLK-CLIP	GC	PLR		M	R							6											SALEABLE						
KEY A, BLACK, WITH CLIPSLOT, W/O CPA	33472-1377	A-BLK-CLIP	GC	PLR		M	R	1	2				5	6	7	8					11	12				SALEABLE					
KEY A, BLACK, WITH CLIPSLOT, W/O CPA	33472-1378	A-BLK-CLIP	GC	PLR		M	R													9						SALEABLE					
KEY A, BLACK, WITH CLIPSLOT, W/O CPA	33472-1379	A-BLK-CLIP	GC	PLR		M	R				3	4							9	10	11	12				SALEABLE					
KEY A, BLACK, WITH CLIPSLOT, W/O CPA	33472-1380	A-BLK-CLIP	GC	PLR		M	R	1	2	3	4	5	6	7	8	9						12				SALEABLE					
KEY A, BLACK, WITH CLIPSLOT, W/O CPA	33472-1381	A-BLK-CLIP	GC	PLR		M	R	1	2				5	6	7	8										SALEABLE					
KEY A, BLACK, WITH CLIPSLOT, W/O CPA	33472-1382	A-BLK-CLIP	GC	PLR		M	R				4					8			10							SALEABLE					
KEY A, BLACK, WITH CLIPSLOT, W/O CPA	33472-1383	A-BLK-CLIP	GC	PLR		M	R	1	2	3	4	5	6					9	10	11	12					SALEABLE					
KEY A, BLACK, WITH CLIPSLOT, W/O CPA	33472-1384	A-BLK-CLIP	GC	PLR		M	R	1			4									11						SALEABLE					
KEY A, BLACK, WITH CLIPSLOT, W/O CPA	33472-1385	A-BLK-CLIP	GC	PLR		M	R													9	10	11	12				SALEABLE				
KEY A, BLACK, WITH CLIPSLOT, W/O CPA	33472-1386	A-BLK-CLIP	GC	PLR		M	R	1	2	3	4	5	6	7	8											SALEABLE					
KEY A, BLACK, WITH CLIPSLOT, W/O CPA	33472-1387	A-BLK-CLIP	GC	PLR		M	R	1	2					6	7	8						12				SALEABLE					
KEY A, BLACK, WITH CLIPSLOT, W/O CPA	33472-1388	A-BLK-CLIP	GC	PLR		M	R	1	2						7	8										SALEABLE					
KEY A, BLACK, WITH CLIPSLOT, W/O CPA	33472-1389	A-BLK-CLIP	GC	PLR		M	R	1						6	7	8						12				SALEABLE					
KEY A, BLACK, WITH CLIPSLOT, W/O CPA	33472-1390	A-BLK-CLIP	GC	PLR		M	R								7	8						12				SALEABLE					
KEY A, BLACK, WITH CLIPSLOT, W/O CPA	33472-1391	A-BLK-CLIP	GC	PLR		M	R		2		4				7	8			9	10						SALEABLE					
KEY A, BLACK, WITH CLIPSLOT, W/O CPA	33472-1392	A-BLK-CLIP	GC	PLR		M	R				3		5	6	7	8	9	10	11	12						SALEABLE					
KEY A, BLACK, WITH CLIPSLOT, W/O CPA	33472-1393	A-BLK-CLIP	GC	PLR		M	R				3					7			9	10	11	12					SALEABLE				
KEY A, BLACK, WITH CLIPSLOT, W/O CPA	33472-1394	A-BLK-CLIP	GC	PLR		M	R													10	11	12					SALEABLE				
KEY A, BLACK, WITH CLIPSLOT, W/O CPA	33472-1395	A-BLK-CLIP	GC	PLR		M	R	1	2	3	4			6	7	8	9	10	11	12						SALEABLE					
KEY A, BLACK, WITH CLIPSLOT, W/O CPA	33472-1396	A-BLK-CLIP	GC	PLR		M	R	1	2	3	4					7	8	9	10							SALEABLE					
KEY A, BLACK, WITH CLIPSLOT, W/O CPA	33472-1397	A-BLK-CLIP	GC	PLR		M	R							6		8	9	10	11	12						SALEABLE					
KEY B, LIGHT GRAY, WITH CLIPSLOT, W/O CPA	33472-1398	B-LG-CLIP	GC	PLR		M	R													10	11	12					SALEABLE				
KEY B, LIGHT GRAY, WITH CLIPSLOT, W/O CPA	33472-1399	B-LG-CLIP	GC	PLR		M	R							6	7					10	11	12					SALEABLE				
KEY B, LIGHT GRAY, WITH CLIPSLOT, W/O CPA	33472-1400	B-LG-CLIP	GC	PLR		M	R	1	2	3	4	5	6	7						10	11	12					SALEABLE				
KEY B, LIGHT GRAY, WITH CLIPSLOT, W/O CPA	33472-1401	B-LG-CLIP	GC	PLR		M	R	1	2	3	4	5	6						9	10	11	12					SALEABLE				
KEY B, LIGHT GRAY, WITH CLIPSLOT, W/O CPA	33472-1402	B-LG-CLIP	GC	PLR		M	R														11	12					SALEABLE				
KEY B, LIGHT GRAY, WITH CLIPSLOT, W/O CPA	33472-1403	B-LG-CLIP	GC	PLR		M	R						5	6					9	10	11	12					SALEABLE				
KEY B, LIGHT GRAY, WITH CLIPSLOT, W/O CPA	33472-1404	B-LG-CLIP	GC	PLR		M	R						5	6					9	10							SALEABLE				
KEY A, BLACK, WITH CLIPSLOT, W/O CPA	33472-1405	A-BLK-CLIP	GC	PLR		M	R									8	9	10	11	12						SALEABLE					
KEY A, BLACK, WITH CLIPSLOT, W/O CPA	33472-1406	A-BLK-CLIP	GC	PLR		M	R									8	9			11						SALEABLE					



MX150 RECEPTACLE 2X6 SEALED ASSEMBLY MAT SEAL  
BOM AND PIN OUT SHEET

ASSEMBLY DESCRIPTION	ASSEMBLY PART NUMBER	COMPONENT						BLOCKED TERMINALS												STATUS	COMMENTS	OPTIONAL ATTACHMENTS SOLD SEPERATELY		
		THE PRESENCE OF AN ABBREVIATION INDICATES THE PRESENCE OF THAT COMPONENT.						CAVITY WITH A NUMBER INDICATES BLOCKED TERMINAL POSITION CAVITY WITHOUT A NUMBER INDICATES OPEN TERMINAL POSITION														BACKSHELL WITH RIBS	BACKSHELL WITHOUT RIBS	
		HOUSING KEY/COLOR	GROMMET CAP	PLR	CPA	MAT SEAL	RING SEAL	1	2	3	4	5	6	7	8	9	10	11	12					
KEY A, BLACK, WITH CLIPSLOT, W/O CPA	33472-1423	A-BLK-CLIP	GC	PLR		M	R	1	2	3	4	5	6	7	8	9				SALEABLE				
KEY A, BLACK, WITH CLIPSLOT, W/O CPA	33472-1424	A-BLK-CLIP	GC	PLR		M	R	1	2	3			6	7	8					SALEABLE				
KEY A, BLACK, WITH CLIPSLOT, W/O CPA	33472-1425	A-BLK-CLIP	GC	PLR		M	R				4									SALEABLE				
KEY A, BLACK, WITH CLIPSLOT, W/O CPA	33472-1426	A-BLK-CLIP	GC	PLR		M	R	1							8					SALEABLE				
KEY A, BLACK, WITH CLIPSLOT, W/O CPA	33472-1427	A-BLK-CLIP	GC	PLR		M	R	1	2			5	6							NOT RECOMMENDED	SEE P/N 33472-1433			
KEY A, BLACK, WITH CLIPSLOT, W/O CPA	33472-1428	A-BLK-CLIP	GC	PLR		M	R			3	4									NOT RECOMMENDED	SEE P/N 33472-1434			
KEY A, BLACK, WITH CLIPSLOT, W/O CPA	33472-1429	A-BLK-CLIP	GC	PLR		M	R	1	2	3	4									NOT RECOMMENDED	SEE P/N 33472-1435			
KEY A, BLACK, WITH CLIPSLOT, W/O CPA	33472-1430	A-BLK-CLIP	GC	PLR		M	R	1	2	3	4	5	6							NOT RECOMMENDED	SEE P/N 33472-1436			
KEY A, BLACK, WITH CLIPSLOT, W/CPA	33472-1431	A-BLK-CLIP	GC	PLR	CPA	M	R							7	8					SALEABLE				
KEY A, BLACK, WITH CLIPSLOT, W/O CPA	33472-1432	A-BLK-CLIP	GC	PLR		M	R			3	4	5	6			9	10	11		SALEABLE				
KEY C, DARK GRAY, WITH CLIPSLOT, W/O CPA	33472-1433	C-DG-CLIP	GC	PLR		M	R	1	2			5	6							SALEABLE				
KEY C, DARK GRAY, WITH CLIPSLOT, W/O CPA	33472-1434	C-DG-CLIP	GC	PLR		M	R			3	4									SALEABLE				
KEY C, DARK GRAY, WITH CLIPSLOT, W/O CPA	33472-1435	C-DG-CLIP	GC	PLR		M	R	1	2	3	4									SALEABLE				
KEY C, DARK GRAY, WITH CLIPSLOT, W/O CPA	33472-1436	C-DG-CLIP	GC	PLR		M	R	1	2	3	4	5	6							SALEABLE				
KEY A, BLACK, WITH CLIPSLOT, W/O CPA	33472-1437	A-BLK-CLIP	GC	PLR		M	R								8	9	10			SALEABLE				
KEY A, BLACK, WITH CLIPSLOT, W/O CPA	33472-1438	A-BLK-CLIP	GC	PLR		M	R	1	2		4				7	8		10		SALEABLE				
KEY A, BLACK, WITH CLIPSLOT, W/O CPA	33472-1439	A-BLK-CLIP	GC	PLR		M	R		2	3		5								SALEABLE				
KEY A, BLACK, WITH CLIPSLOT, W/O CPA	33472-1440	A-BLK-CLIP	GC	PLR		M	R	1	2	3						9				SALEABLE				
KEY A, BLACK, WITH CLIPSLOT, W/O CPA	33472-1441	A-BLK-CLIP	GC	PLR		M	R	1	2	3	PLR		5			9				SALEABLE				
KEY A, BLACK, WITH CLIPSLOT, W/O CPA	33472-1442	A-BLK-CLIP	GC	PLR		M	R	1	2	3	4	5		7	8					SALEABLE				
KEY A, BLACK, WITH CLIPSLOT, W/O CPA	33472-1443	A-BLK-CLIP	GC	PLR		M	R					5			8					SALEABLE				
KEY A, BLACK, WITH CLIPSLOT, W/O CPA	33472-1444	A-BLK-CLIP	GC	PLR		M	R		2			5				9				SALEABLE				
KEY A, BLACK, WITH CLIPSLOT, W/O CPA	33472-1445	A-BLK-CLIP	GC	PLR		M	R		2			5		7		9				SALEABLE				
KEY A, BLACK, WITH CLIPSLOT, W/O CPA	33472-1446	A-BLK-CLIP	GC	PLR		M	R			2					9					SALEABLE				
KEY A, BLACK, WITH CLIPSLOT, W/O CPA	33472-1447	A-BLK-CLIP	GC	PLR		M	R	1	2	3	4		6							SALEABLE				
KEY B, LIGHT GRAY, WITH CLIPSLOT, W/O CPA	33472-1448	B-LG-CLIP	GC	PLR		M	R	1	2	3	4				8	9	10	11	12	SALEABLE				
KEY B, LIGHT GRAY, WITH CLIPSLOT, W/O CPA	33472-1449	B-LG-CLIP	GC	PLR		M	R					5			8					SALEABLE				
KEY B, LIGHT GRAY, WITH CLIPSLOT, W/O CPA	33472-1450	B-LG-CLIP	GC	PLR		M	R					5			8	9	10	11	12	SALEABLE				
KEY B, LIGHT GRAY, WITH CLIPSLOT, W/O CPA	33472-1451	B-LG-CLIP	GC	PLR		M	R					5			8					SALEABLE				
KEY A, BLACK, WITH CLIPSLOT, W/CPA	33472-1452	A-BLK-CLIP	GC	PLR	CPA	M	R											11	12	SALEABLE				
KEY A, BLACK, WITH CLIPSLOT, W/O CPA	33472-1453	A-BLK-CLIP	GC	PLR		M	R		2						8					SALEABLE				
KEY A, BLACK, WITH CLIPSLOT, W/O CPA	33472-1454	A-BLK-CLIP	GC	PLR		M	R		2						8					SALEABLE				
KEY A, BLACK, WITH CLIPSLOT, W/O CPA	33472-1455	A-BLK-CLIP	GC	PLR		M	R	1	2	3	4	5	6		8			10	11	12	SALEABLE			
KEY A, BLACK, WITH CLIPSLOT, W/O CPA	33472-1456	A-BLK-CLIP	GC	PLR		M	R	1	2	3	4	5	6		8			10	11	12	SALEABLE			
KEY A, BLACK, WITH CLIPSLOT, W/O CPA	33472-1457	A-BLK-CLIP	GC	PLR		M	R	1	2	3	4	5	6		8			10	11	12	SALEABLE			
KEY A, BLACK, WITH CLIPSLOT, W/O CPA	33472-1458	A-BLK-CLIP	GC	PLR		M	R	1		3		5	6		8	9	10	11	12	SALEABLE				
KEY A, BLACK, WITH CLIPSLOT, W/O CPA	33472-1459	A-BLK-CLIP	GC	PLR		M	R				4	5	6	7	8	9	10	11	12	SALEABLE				
KEY A, BLACK, WITH CLIPSLOT, W/O CPA	33472-1460	A-BLK-CLIP	GC	PLR		M	R				4			7	8	9	10	11	12	SALEABLE				
KEY A, BLACK, WITH CLIPSLOT, W/O CPA	33472-1461	A-BLK-CLIP	GC	PLR		M	R	1	2	3	4	5	6		8	9	10	11	12	SALEABLE				
KEY A, BLACK, W/O CPA	33472-1462	A-BLK	GC	PLR		M	R				4				9	10	11	12		SALEABLE				
KEY A, BLACK, W/O CPA	33472-1463	A-BLK	GC	PLR		M	R													SALEABLE				
KEY A, BLACK, W/O CPA	33472-1464	A-BLK	GC	PLR		M	R	1	2	3	4	5	6	7	8	9	10			SALEABLE				
KEY A, BLACK, W/CPA	33472-1465	A-BLK	GC	PLR	CPA	M	R					5			9					SALEABLE				
KEY A, BLACK, W/CPA	33472-1466	A-BLK	GC	PLR	CPA	M	R	1	2	3				6	7					SALEABLE				
KEY A, BLACK, W/CPA	33472-1467	A-BLK	GC	PLR	CPA	M	R	1	2					6	7	8	9	10	11	12	SALEABLE			
KEY A, BLACK, W/CPA	33472-1468	A-BLK	GC	PLR	CPA	M	R							6	7	8	9	10	11	12	SALEABLE			
KEY A, BLACK, WITH CLIPSLOT, W/O CPA	33472-1469	A-BLK-CLIP	GC	PLR		M	R				5	6	7				10			SALEABLE				
KEY A, BLACK, WITH CLIPSLOT, W/O CPA	33472-1470	A-BLK-CLIP	GC	PLR		M	R	1	2		4	5	6	7						SALEABLE				
KEY B, LIGHT GRAY, W/CPA	33472-1471	B-LG	GC	PLR	CPA	M	R					5								SALEABLE				
KEY A, BLACK, WITH CLIPSLOT, W/O CPA	33472-1472	A-BLK-CLIP	GC	PLR		M	R							7	8					SALEABLE				
KEY A, BLACK, WITH CLIPSLOT, W/O CPA	33472-1473	A-BLK-CLIP	GC	PLR		M	R	1	2	3	4				7	8	9	10	11		SALEABLE			
KEY A, BLACK, WITH CLIPSLOT, W/O CPA	33472-1474	A-BLK-CLIP	GC	PLR		M	R					5	6	7						SALEABLE				
KEY A, BLACK, W/CPA	33472-1475	A-BLK	GC	PLR	CPA	M	R		2	3	4				9					SALEABLE				
KEY A, BLACK, W/CPA	33472-1476	A-BLK	GC	PLR	CPA	M	R		2	3	4				9	10	11			SALEABLE				
KEY A, BLACK, WITH CLIPSLOT, W/O CPA	33472-1477	A-BLK-CLIP	GC	PLR		M	R					5								SALEABLE				
KEY A, BLACK, WITH CLIPSLOT, W/O CPA	33472-1478	A-BLK-CLIP	GC	PLR		M	R				3	4								SALEABLE				
KEY A, BLACK, WITH CLIPSLOT, W/O CPA	33472-1479	A-BLK-CLIP	GC	PLR		M	R						6							SALEABLE				
KEY A, BLACK, WITH CLIPSLOT, W/O CPA	33472-1480	A-BLK-CLIP	GC	PLR		M	R	1	2		4	5	6	7						SALEABLE				
KEY A, BLACK, WITH CLIPSLOT, W/O CPA	33472-1481	A-BLK-CLIP	GC	PLR		M	R					5			8	9				SALEABLE				
KEY A, BLACK, WITH CLIPSLOT, W/O CPA	33472-1482	A-BLK-CLIP	GC	PLR		M	R					5			7	8	9			SALEABLE				
KEY A, BLACK, W/CPA	33472-1483	A-BLK	GC	PLR	CPA	M	R				4									SALEABLE				
KEY A, BLACK, W/O CPA	33472-1484	A-BLK	GC	PLR		M	R							7	8	9	10	11	12	SALEABLE				
KEY A, BLACK, W/O CPA	33472-1485	A-BLK	GC	PLR		M	R				4	5								SALEABLE				
KEY A, BLACK, W/CPA	33472-1486	A-BLK	GC	PLR	CPA	M	R	1		3		5			8					SALEABLE				
KEY A, BLACK, W/CPA	33472-1487	A-BLK	GC	PLR	CPA	M	R		2		4			6	7	8	9	10	11	12	SALEABLE			
KEY A, BLACK, W/O CPA	33472-1488	A-BLK	GC	PLR		M	R				3			6	7	8	9	10	11	12	SALEABLE			
KEY A, BLACK, W/O CPA	33472-1489	A-BLK	GC	PLR		M	R				3				7	8	9			SALEABLE				
KEY A, BLACK, W/O CPA	33472-1490	A-BLK	GC	PLR		M	R				3	PLR			6					SALEABLE				
KEY A, BLACK, W/O CPA	33472-1491	A-BLK	GC	PLR		M	R						6	7	8					SALEABLE				
KEY A, BLACK, W/O CPA	33472-1492	A-BLK	GC	PLR		M	R						6							SALEABLE				
KEY A, BLACK, W/O CPA	33472-1493	A-BLK	GC	PLR		M	R				3					9				SALEABLE				
KEY A, BLACK, W/O CPA	33472-1494	A-BLK	GC	PLR		M	R					5	6	7						SALEABLE				
KEY A, BLACK, W/O CPA	33472-1495	A-BLK	GC	PLR		M	R				2				6					SALEABLE				
KEY A, BLACK, W/O CPA	33472-1496	A-BLK	GC	PLR		M	R				2				6					SALEABLE				
KEY A, BLACK, W/O CPA	33472-1497	A-BLK	GC	PLR		M	R	1						6	7					SALEABLE				
KEY A, BLACK, W/O CPA	33472-1498	A-BLK	GC	PLR		M	R	1			3	4	5	6	7	8				SALEABLE				
KEY A, BLACK, W/O CPA	33472-1499	A-BLK	GC</																					



MX150 RECEPTACLE 2X8 SEALED ASSEMBLY MAT SEAL  
BOM AND PIN OUT SHEET

ASSEMBLY DESCRIPTION	ASSEMBLY PART NUMBER	COMPONENT						BLOCKED TERMINALS																STATUS	COMMENTS	OPTIONAL ATTACHMENTS SOLD SEPERATELY				
		THE PRESENCE OF AN ABBREVIATION INDICATES THE PRESENCE OF THAT COMPONENT.						CAVITY WITH A NUMBER INDICATES BLOCKED TERMINAL POSITION CAVITY WITHOUT A NUMBER INDICATES OPEN TERMINAL POSITION																		BACKSHELL WITH RIBS	BACKSHELL WITHOUT RIBS			
		HOUSING KEY/COLOR	GROMMET CAP	PLR	CPA	MAT SEAL	RING SEAL	1	2	3	4	5	6	7	8	9	10	11	12	13	14	15	16							
KEY A, BLACK, W/O CPA	33472-1663	A-BLK	GC	PLR		M	R	1			4		6	7	8	9			12	13	14				SALEABLE					
KEY A, BLACK, W/O CPA	33472-1664	A-BLK	GC	PLR		M	R			3	4	5		7	8	9	10	11	12	13	14	15	16		SALEABLE					
KEY A, BLACK, W/O CPA	33472-1665	A-BLK	GC	PLR		M	R							7	8	9			12	13	14				SALEABLE					
KEY A, BLACK, W/O CPA	33472-1666	A-BLK	GC	PLR		M	R			3	4	5					10	11	12	13	14	15	16		SALEABLE					
KEY A, BLACK, W/O CPA	33472-1667	A-BLK	GC	PLR		M	R				3	4	5			9	10	11	12	13	14	15	16		SALEABLE					
KEY A, BLACK, W/O CPA	33472-1668	A-BLK	GC	PLR		M	R	1																	SALEABLE					
KEY B, LIGHT GRAY, W/O CPA	33472-1669	B-LG	GC	PLR		M	R							8					12	13	14	15	16		SALEABLE					
KEY B, LIGHT GRAY, W/O CPA	33472-1670	B-LG	GC	PLR		M	R							8						13	14	15	16		SALEABLE					
KEY B, LIGHT GRAY, W/O CPA	33472-1671	B-LG	GC	PLR		M	R									10	11								SALEABLE					
KEY B, LIGHT GRAY, W/O CPA	33472-1672	B-LG	GC	PLR		M	R									10	11	12							SALEABLE					
KEY A, BLACK, W/CPA	33472-1673	A-BLK	GC	PLR	CPA	M	R									10	11		13	14	15	16		SALEABLE						
KEY B, LIGHT GRAY, W/O CPA	33472-1674	B-LG	GC	PLR		M	R											12							SALEABLE					
KEY A, BLACK, W/CPA	33472-1675	A-BLK	GC	PLR	CPA	M	R									10	11					15	16		SALEABLE					
KEY A, BLACK, W/CPA	33472-1676	A-BLK	GC	PLR	CPA	M	R							8	9	10	11	12				15	16		SALEABLE					
KEY B, LIGHT GRAY, W/O CPA	33472-1677	B-LG	GC	PLR		M	R				4		6	7	8				12		14				SALEABLE					
KEY A, BLACK, W/O CPA	33472-1678	A-BLK	GC	PLR		M	R					5													SALEABLE					
KEY A, BLACK, W/O CPA	33472-1679	A-BLK	GC	PLR		M	R					5													SALEABLE					
KEY A, BLACK, W/CPA	33472-1680	A-BLK	GC	PLR	CPA	M	R															15	16		SALEABLE					
KEY A, BLACK, W/O CPA	33472-1681	A-BLK	GC	PLR		M	R						2		5		7				14				SALEABLE					
KEY B, LIGHT GRAY, W/O CPA	33472-1682	B-LG	GC	PLR		M	R				4														SALEABLE					
KEY A, BLACK, W/O CPA	33472-1683	A-BLK	GC	PLR		M	R																	16	SALEABLE					
KEY A, BLACK, W/O CPA	33472-1684	A-BLK	GC	PLR		M	R				4								12						SALEABLE					
KEY B, LIGHT GRAY, W/O CPA	33472-1685	B-LG	GC	PLR		M	R																16		SALEABLE					
KEY B, LIGHT GRAY, W/O CPA	33472-1686	B-LG	GC	PLR		M	R				4								12		14				SALEABLE					
KEY B, LIGHT GRAY, W/O CPA	33472-1687	B-LG	GC	PLR		M	R														14				SALEABLE					
KEY A, BLACK, W/O CPA	33472-1688	A-BLK	GC	PLR		M	R			2															SALEABLE					
KEY B, LIGHT GRAY, W/O CPA	33472-1689	B-LG	GC	PLR		M	R			2		4							12		14				SALEABLE					
KEY B, LIGHT GRAY, W/O CPA	33472-1690	B-LG	GC	PLR		M	R			2											14				SALEABLE					
KEY A, BLACK, W/O CPA	33472-1691	A-BLK	GC	PLR		M	R			2		4							12						SALEABLE					
KEY A, BLACK, W/O CPA	33472-1692	A-BLK	GC	PLR		M	R				4			8					12						SALEABLE					
KEY B, LIGHT GRAY, W/O CPA	33472-1693	B-LG	GC	PLR		M	R				4			8					12		14				SALEABLE					
KEY B, LIGHT GRAY, W/O CPA	33472-1694	B-LG	GC	PLR		M	R							8							14				SALEABLE					
KEY A, BLACK, W/O CPA	33472-1695	A-BLK	GC	PLR		M	R			2				8											SALEABLE					
NOT AVAILABLE	33472-1696																													
NOT AVAILABLE	33472-1697																													
NOT AVAILABLE	33472-1698																													
NOT AVAILABLE	33472-1699																													
NOT AVAILABLE	33472-1700																													
KEY A, BLACK, W/O CPA	33472-1701	A-BLK	GC	PLR		M	R				2		4						12						SALEABLE					
KEY B, LIGHT GRAY, W/O CPA	33472-1702	B-LG	GC	PLR		M	R			2		4							12		14				SALEABLE					
KEY B, LIGHT GRAY, W/O CPA	33472-1703	B-LG	GC	PLR		M	R			2				8							14				SALEABLE					
KEY A, BLACK, W/O CPA	33472-1704	A-BLK	GC	PLR		M	R				2		4												SALEABLE					
KEY B, LIGHT GRAY, W/O CPA	33472-1705	B-LG	GC	PLR		M	R			2		4									14				SALEABLE					
KEY A, BLACK, W/O CPA	33472-1706	A-BLK	GC	PLR		M	R			2						6			10		13	14	15	16	SALEABLE					
KEY A, BLACK, W/O CPA	33472-1707	A-BLK	GC	PLR		M	R			2				6			10	11		13	14	15	16		SALEABLE					
KEY A, BLACK, W/O CPA	33472-1708	A-BLK	GC	PLR		M	R			2				6			10			13	14				SALEABLE					
KEY A, BLACK, W/O CPA	33472-1709	A-BLK	GC	PLR		M	R					4				8									SALEABLE					
KEY A, BLACK, W/O CPA	33472-1710	A-BLK	GC	PLR		M	R			2				6				11							SALEABLE					
KEY A, BLACK, W/O CPA	33472-1711	A-BLK	GC	PLR		M	R			2				6											SALEABLE					
KEY A, BLACK, W/CPA	33472-1712	A-BLK	GC	PLR	CPA	M	R						5	6	7	8				13				SALEABLE						
KEY A, BLACK, W/CPA	33472-1713	A-BLK	GC	PLR	CPA	M	R						5	6	7	8			11	12	13	14		SALEABLE						
KEY A, BLACK, W/CPA	33472-1714	A-BLK	GC	PLR	CPA	M	R						5	6	7	8				12	13	14		SALEABLE						
KEY B, LIGHT GRAY, W/CPA	33472-1715	B-LG	GC	PLR	CPA	M	R	1	2	3	4	5	6	7	8				10		12	13		SALEABLE						
KEY B, LIGHT GRAY, W/CPA	33472-1716	B-LG	GC	PLR	CPA	M	R	1		3	4	5	6	7	8				10					SALEABLE						
KEY B, LIGHT GRAY, W/CPA	33472-1717	B-LG	GC	PLR	CPA	M	R	1			4	5	6	7	8				10					SALEABLE						
KEY A, BLACK, W/CPA	33472-1718	A-BLK	GC	PLR	CPA	M	R					5	6	7	8						13				SALEABLE					
KEY A, BLACK, W/CPA	33472-1719	A-BLK	GC	PLR	CPA	M	R					4	5	6	7	8						15	16		SALEABLE					
KEY A, BLACK, W/CPA	33472-1720	A-BLK	GC	PLR	CPA	M	R				3	4	5	6	7	8						15	16		SALEABLE					
KEY A, BLACK, W/CPA	33472-1721	A-BLK	GC	PLR	CPA	M	R								8					13	14	15	16		SALEABLE					
KEY A, BLACK, W/CPA	33472-1722	A-BLK	GC	PLR	CPA	M	R	1	2	3	4	5	6	7	8					13	14	15	16		SALEABLE					
KEY A, BLACK, W/CPA	33472-1723	A-BLK	GC	PLR	CPA	M	R								7	8			11	12	13	14		SALEABLE						
KEY A, BLACK, W/CPA	33472-1724	A-BLK	GC	PLR	CPA	M	R								7	8				12	13	14		SALEABLE						
KEY A, BLACK, W/CPA	33472-1725	A-BLK	GC	PLR	CPA	M	R								7	8					13				SALEABLE					
KEY A, BLACK, W/CPA	33472-1726	A-BLK	GC	PLR	CPA	M	R								7	8									SALEABLE					
KEY A, BLACK, W/CPA	33472-1727	A-BLK	GC	PLR	CPA	M	R													11		13	14	15	16	SALEABLE				
KEY B, LIGHT GRAY, W/CPA	33472-1728	B-LG	GC	PLR	CPA	M	R					4	5	6	7	8				12				SALEABLE						
KEY B, LIGHT GRAY, W/CPA	33472-1729	B-LG	GC	PLR	CPA	M	R	1	2		4	5	6	7	8				10		12	13		SALEABLE						
KEY B, LIGHT GRAY, W/CPA	33472-1730	B-LG	GC	PLR	CPA	M	R			2		4	5	6	7	8				10	11	12	13	16	SALEABLE					
KEY B, LIGHT GRAY, W/CPA	33472-1731	B-LG	GC	PLR	CPA	M	R					4	5	6	7	8					12	13			SALEABLE					
KEY B, LIGHT GRAY, W/CPA	33472-1732	B-LG	GC	PLR	CPA	M	R			2		4	5	6	7</															

BOM AND PIN OUT SHEET

ASSEMBLY DESCRIPTION	ASSEMBLY PART NUMBER	COMPONENT						BLOCKED TERMINALS																STATUS	COMMENTS	OPTIONAL ATTACHMENTS SOLD SEPERATELY			
		THE PRESENCE OF AN ABBREVIATION INDICATES THE PRESENCE OF THAT COMPONENT.						CAVITY WITH A NUMBER INDICATES BLOCKED TERMINAL POSITION CAVITY WITHOUT A NUMBER INDICATES OPEN TERMINAL POSITION																		BACKSHELL WITH RIBS	BACKSHELL WITHOUT RIBS		
		HOUSING KEY/COLOR	GROMMET CAP	PLR	CPA	MAT SEAL	RING SEAL	1	2	3	4	5	6	7	8	9	10	11	12	13	14	15	16						
KEY A, BLACK, W/O CPA	33472-1752	A-BLK	GC	PLR		M	R											10	11	12	13	14	15	16	SALEABLE				
KEY A, BLACK, W/O CPA	33472-1753	A-BLK	GC	PLR		M	R												11	12	13	14	15	16	SALEABLE				
KEY A, BLACK, W/O CPA	33472-1754	A-BLK	GC	PLR		M	R	1	2	3	4	5	6												SALEABLE				
KEY A, BLACK, W/O CPA	33472-1755	A-BLK	GC	PLR		M	R							8	9						14	15	16	SALEABLE					
KEY A, BLACK, W/O CPA	33472-1756	A-BLK	GC	PLR		M	R												12	13	14	15	16	SALEABLE					
KEY A, BLACK, W/O CPA	33472-1757	A-BLK	GC	PLR		M	R					7	8	9	10									SALEABLE					
KEY A, BLACK, W/O CPA	33472-1758	A-BLK	GC	PLR		M	R														14	15	16	SALEABLE					
KEY A, BLACK, W/O CPA	33472-1759	A-BLK	GC	PLR		M	R		2			6	7	8										SALEABLE					
KEY A, BLACK, W/O CPA	33472-1760	A-BLK	GC	PLR		M	R		2		4	6	7	8					12					SALEABLE					
KEY A, BLACK, W/O CPA	33472-1761	A-BLK	GC	PLR		M	R		2			5	6	7	8	9	10				14	15	16	SALEABLE					
KEY A, BLACK, W/O CPA	33472-1762	A-BLK	GC	PLR		M	R		2			5	6	7	8						14	15	16	SALEABLE					
KEY A, BLACK, W/O CPA	33472-1763	A-BLK	GC	PLR		M	R		2							9	10						15	16	SALEABLE				
KEY A, BLACK, W/O CPA	33472-1764	A-BLK	GC	PLR		M	R		2								10							SALEABLE					
KEY A, BLACK, W/O CPA	33472-1765	A-BLK	GC	PLR		M	R	1	2	3	4	5	6	7	8	9	10							SALEABLE					
KEY A, BLACK, W/O CPA	33472-1766	A-BLK	GC	PLR		M	R	1	2	3	4	5	6				10	11	12	13	14	15	16	SALEABLE					
KEY C, DARK GRAY, W/O CPA	33472-1767	C-DG	GC	PLR		M	R																	SALEABLE					
KEY D, STONE GRAY, W/O CPA	33472-1768	D-SG	GC	PLR		M	R																	SALEABLE					
KEY C, DARK GRAY, W/CPA	33472-1769	C-DG	GC	PLR	CPA	M	R																	SALEABLE					
KEY D, STONE GRAY, W/CPA	33472-1770	D-SG	GC	PLR	CPA	M	R																	SALEABLE					
KEY B, LIGHT GRAY, W/O CPA	33472-1771	B-LG	GC	PLR		M	R	1	2	3	4	5	6	7	8	9	10					14	15	16	SALEABLE				
KEY B, LIGHT GRAY, W/O CPA	33472-1772	B-LG	GC	PLR		M	R	1	2	3	4	5	6	7	8	9	10					14	15	SALEABLE					
KEY B, LIGHT GRAY, W/CPA	33472-1773	B-LG	GC	PLR	CPA	M	R				4	5					10	11	12	13				SALEABLE					
KEY B, LIGHT GRAY, W/CPA	33472-1774	B-LG	GC	PLR	CPA	M	R				4	5		8			10	11	12	13				SALEABLE					
KEY B, LIGHT GRAY, W/CPA	33472-1775	B-LG	GC	PLR	CPA	M	R				4	5		8			10	11	12	13			16	SALEABLE					
KEY B, LIGHT GRAY, W/CPA	33472-1776	B-LG	GC	PLR	CPA	M	R				4	5		8			10	11	12	13				SALEABLE					
KEY B, LIGHT GRAY, W/CPA	33472-1777	B-LG	GC	PLR	CPA	M	R				4	5		8			10	11	12	13				SALEABLE					
KEY A, BLACK, W/O CPA	33472-1778	A-BLK	GC	PLR		M	R			3	4				9	10							15	16	SALEABLE				
KEY A, BLACK, W/O CPA	33472-1779	A-BLK	GC	PLR		M	R		2		4		6	7		9	10			11			15	16	SALEABLE				
KEY A, BLACK, W/CPA	33472-1780	A-BLK	GC	PLR	CPA	M	R															14	15	16	SALEABLE				
KEY A, BLACK, W/O CPA	33472-1781	A-BLK	GC	PLR		M	R				4	5		7										SALEABLE					
KEY A, BLACK, W/CPA	33472-1782	A-BLK	GC	PLR	CPA	M	R												12	13	14	15	16	SALEABLE					
KEY A, BLACK, W/O CPA	33472-1783	A-BLK	GC	PLR		M	R	1	2	3	4			7	8	9	10	11	12			15	16	SALEABLE					
KEY A, BLACK, W/O CPA	33472-1784	A-BLK	GC	PLR		M	R	1	2	3	4			8	9	10	11	12					16	SALEABLE					
KEY A, BLACK, W/O CPA	33472-1785	A-BLK	GC	PLR		M	R		2	3	4				9	10							15	16	SALEABLE				
KEY A, BLACK, W/O CPA	33472-1786	A-BLK	GC	PLR		M	R		2	3	4	5	6	7	8	9	10	12			14	15	16	SALEABLE					
KEY A, BLACK, W/O CPA	33472-1787	A-BLK	GC	PLR		M	R					5		8			10	11		13			15	SALEABLE					
KEY A, BLACK, W/O CPA	33472-1788	A-BLK	GC	PLR		M	R			3		5		8			10	11		13			15	SALEABLE					
KEY A, BLACK, W/O CPA	33472-1789	A-BLK	GC	PLR		M	R					5		8			10	11			14			SALEABLE					
KEY A, BLACK, W/O CPA	33472-1790	A-BLK	GC	PLR		M	R				3	4	5		8		10	11	12	13	14	15		SALEABLE					
KEY A, BLACK, W/O CPA	33472-1791	A-BLK	GC	PLR		M	R				3	4	5		8	9	10					15	16	SALEABLE					
KEY A, BLACK, W/O CPA	33472-1792	A-BLK	GC	PLR		M	R	1		3		5		7	8		10	11				14	15	16	SALEABLE				
KEY A, BLACK, W/O CPA	33472-1793	A-BLK	GC	PLR		M	R														13	14	15	16	SALEABLE				
KEY A, BLACK, W/O CPA	33472-1794	A-BLK	GC	PLR		M	R		2		4		6	7	8				12					SALEABLE					
KEY A, BLACK, W/CPA	33472-1795	A-BLK	GC	PLR	CPA	M	R															14		SALEABLE					
KEY A, BLACK, W/O CPA	33472-1796	A-BLK	GC	PLR		M	R	1				5		7	8		10	11					15	SALEABLE					
KEY A, BLACK, W/O CPA	33472-1797	A-BLK	GC	PLR		M	R					5		8			10	11						SALEABLE					
KEY A, BLACK, W/O CPA	33472-1798	A-BLK	GC	PLR		M	R	1		3		5		7				11					15	SALEABLE					
KEY B, LIGHT GRAY, W/CPA	33472-1799	B-LG	GC	PLR	CPA	M	R		2		4			8					12			14		SALEABLE					
KEY A, BLACK, W/O CPA	33472-1800	A-BLK	GC	PLR		M	R	1		3		5												SALEABLE					
KEY B, LIGHT GRAY, W/CPA	33472-1801	B-LG	GC	PLR	CPA	M	R				4	5			8					12	13			SALEABLE					
KEY B, LIGHT GRAY, W/CPA	33472-1802	B-LG	GC	PLR	CPA	M	R		2		4	5	6		8					12	13			SALEABLE					
KEY B, LIGHT GRAY, W/CPA	33472-1803	B-LG	GC	PLR	CPA	M	R		2		4	5	6		8			10			12	13		SALEABLE					
KEY B, LIGHT GRAY, W/CPA	33472-1804	B-LG	GC	PLR	CPA	M	R		2	3	4	5	6		8					12	13			SALEABLE					
KEY A, BLACK, W/O CPA	33472-1805	A-BLK	GC	PLR		M	R														14	15		SALEABLE					
KEY A, BLACK, W/CPA	33472-1806	A-BLK	GC	PLR	CPA	M	R	1		3	4									12	13	14	15	16	SALEABLE				
KEY A, BLACK, W/CPA	33472-1807	A-BLK	GC	PLR	CPA	M	R	1	2	3	4	5		8				11	12	13	14	15	16	SALEABLE					
KEY A, BLACK, W/CPA	33472-1808	A-BLK	GC	PLR	CPA	M	R		2	3	4	5		8				11						SALEABLE					
KEY A, BLACK, W/CPA	33472-1809	A-BLK	GC	PLR	CPA	M	R			3	4													SALEABLE					
KEY A, BLACK, W/O CPA	33472-1810	A-BLK	GC	PLR		M	R	1	2	3	4	5	6	7	8						13	14	15	16	SALEABLE				
KEY A, BLACK, W/O CPA	33472-1811	A-BLK	GC	PLR		M	R	1	2	3											13	14	15	SALEABLE					
KEY A, BLACK, W/O CPA	33472-1812	A-BLK	GC	PLR		M	R	1	2												13	14	15	SALEABLE					
KEY B, LIGHT GRAY, W/O CPA	33472-1813	B-LG	GC	PLR		M	R					6	7	8				11						SALEABLE					
KEY B, LIGHT GRAY, W/O CPA	33472-1814	B-LG	GC	PLR		M	R					6	7	8							14			SALEABLE					
KEY B, LIGHT GRAY, W/O CPA	33472-1815	B-LG	GC	PLR		M	R					6			9			11	12	13		15	16	SALEABLE					
KEY B, LIGHT GRAY, W/O CPA	33472-1816	B-LG	GC	PLR		M	R					6			9	10	11	12	13	14	15	16	SALEABLE						
KEY B, LIGHT GRAY, W/O CPA	33472-1817	B-LG	GC	PLR		M	R	1	2	3	4	5	6		9	10	11	12	13	14	15	16	SALEABLE						
KEY A, BLACK, W/O CPA	33472-1818	A-BLK	GC	PLR		M	R								9	10	11	12	13	14	15	16	SALEABLE						
KEY A, BLACK, W/CPA	33472-1819	A-BLK	GC	PLR	CPA	M	R				4	5	6	7	8	9	10	11	12	13	14	15	16	SALEABLE					
KEY A, BLACK,																													



**MX150 RECEPTACLE 2X8 SEALED ASSEMBLY MAT SEAL  
BOM AND PIN OUT SHEET**

ASSEMBLY DESCRIPTION	ASSEMBLY PART NUMBER	COMPONENT						BLOCKED TERMINALS																STATUS	COMMENTS	OPTIONAL ATTACHMENTS SOLD SEPERATELY							
		THE PRESENCE OF AN ABBREVIATION INDICATES THE PRESENCE OF THAT COMPONENT.						CAVITY WITH A NUMBER INDICATES BLOCKED TERMINAL POSITION CAVITY WITHOUT A NUMBER INDICATES OPEN TERMINAL POSITION																		BACKSHELL WITH RIBS	BACKSHELL WITHOUT RIBS						
		HOUSING KEY/COLOR	GROMMET CAP	PLR	CPA	MAT SEAL	RING SEAL	1	2	3	4	5	6	7	8	9	10	11	12	13	14	15	16										
KEY A, BLACK, W/O CPA	33472-1932	A-BLK	GC	PLR		M	R	1	2		4	5	6									10						14			SALEABLE		