

APPLICABLE FFC LAYOUT

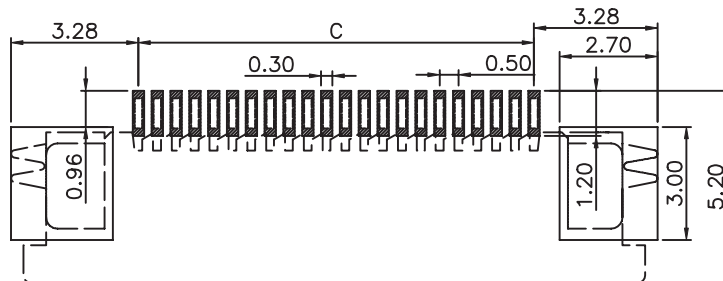

RECOMMENDED PCB LAYOUT - COMPONENT VIEW

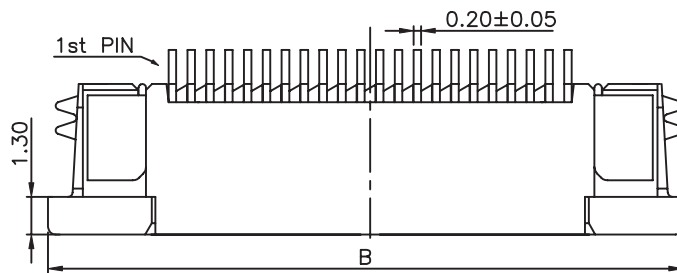
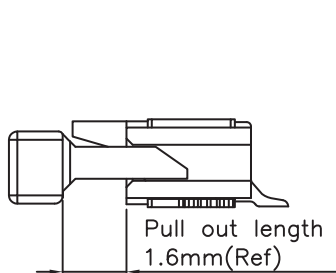
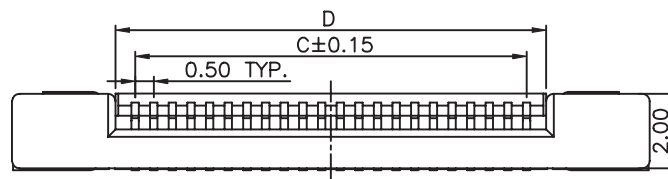
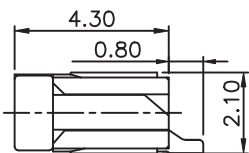
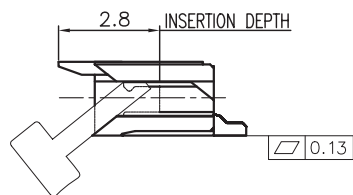

MATERIAL:  
 HOUSING MATERIAL: LCP  
 COLOR: IVORY  
 ACTUATOR MATERIAL: LCP  
 COLOR: BLACK  
 CONTACT MATERIAL: PHOSPOR BRONZE  
 CONTACT PLATING: 100µ" TIN OVER 50µ" NI  
 QUALITY CLASS: 25 MATING CYCLES\*

ENVIRONMENTAL:  
 OPERATING TEMPERATURE: -25°C UP TO 85°C  
 FLAMABILITY RATING: UL94-V0  
 COMPLIANCE: LEAD FREE AND ROHS

ELECTRICAL:  
 CURRENT RATING: 0.5 A  
 WORKING VOLTAGE: 50 V  
 INSULATION RESISTANCE: >100 MOHM  
 DIELECTRIC WITHSTANDING VOLT.: 250 VAC/MN  
 CONTACT RESISTANCE: 20 MOHM MAX

STANDARD  
 A CERTIFIED: E323964 / MODEL NUMBER 687  
 FOLLOWED BY 1, FOLLOWED BY 04 THRU 50, FOLLOWED  
 BY 140 OR 145, FOLLOWED BY NUMERIC DIGITS



SOLDERING:  
 REFLOW PROCESS ONLY

DIMENSION:  
 B = 0.50 x NB PINS + 6.50  
 C = 0.50 x (NB PINS - 1)  
 D = 0.50 x (NB PINS + 1) + 0.10  
 E = 0.50 x (NB PINS + 1)

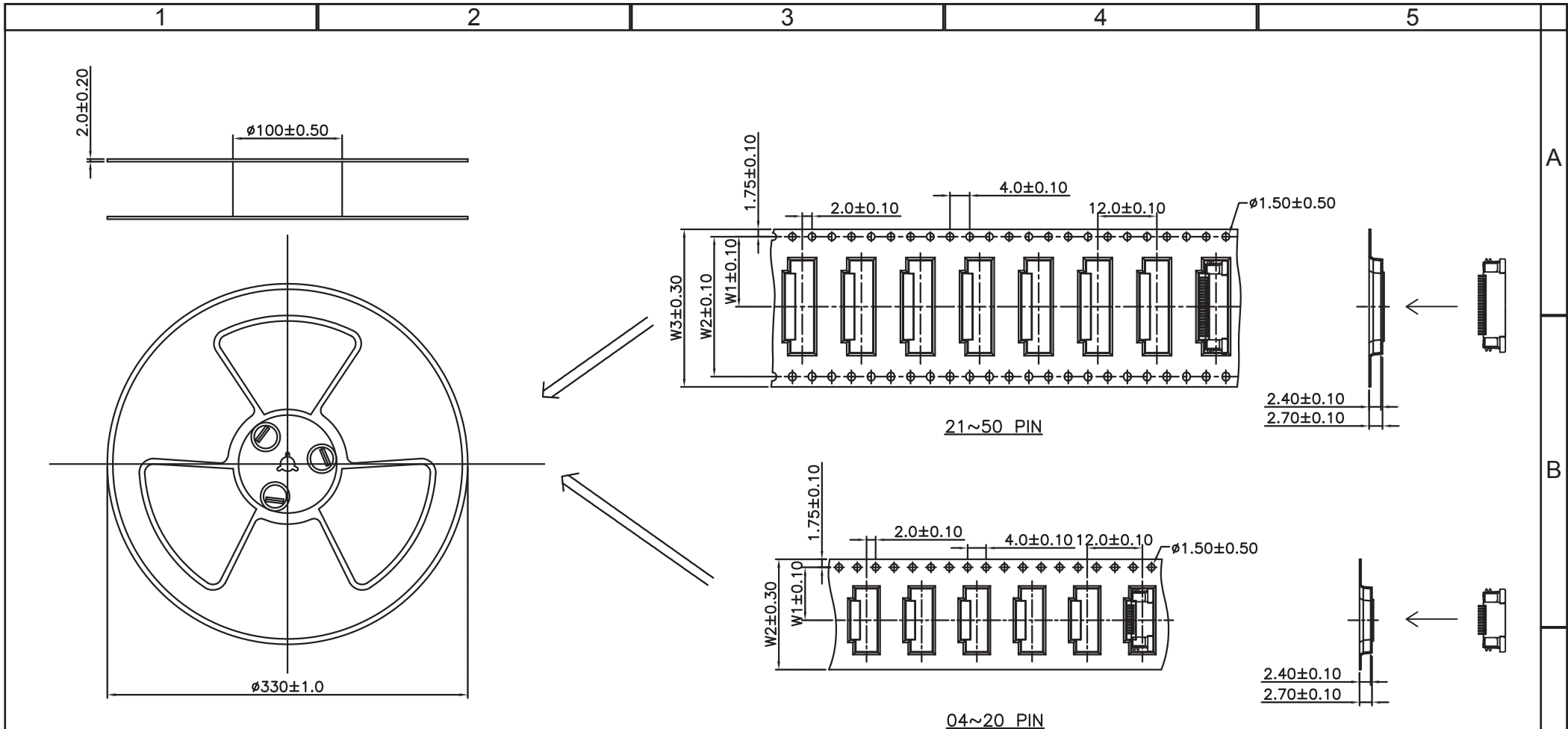
RoHS Compliant		*NOTE: theoretical value related to the Tin plating; however, due to the sensitive actuator, we recommend not to make more than 1 or 2 cycles in order to maintain acceptable mechanical & electrical conditions					
				PROJECTION: 	GENERAL TOLERANCE .X = +/- 0.2 .XX = +/- 0.15		
J	07-JAN-16	DRAWING	AK	APPROVAL: GMo	 <b>WÜRTH ELEKTRONIK</b>		
I	01-JUN-15	TPK UPDATE	QL				
H	13-DEC-13	TPK UPDATE	QL				
REV	DATE	FILE	BY				
					UNIT: MM	DESCRIPTION: 0.5MM ZIF FPC HORIZONTAL TOP CONTACT TYPE - TAPE & REEL PACKAGING	SIZE <b>A4</b>
					SCALE:		
					SHEET: 1/3		
					DRAW: PEARL	WERI PART NO: 687 1xx 140 22	

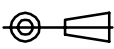

NOTE: 1. 04~06PIN: DIM W1:7.5mm W2:16.0mm PH:12mm  
 07~20PIN: DIM W1:11.5mm W2:24.0mm PH:12mm BUT 16PIN AND 20PIN PH:8mm  
 21~30PIN: DIM W1:14.2mm W2:28.4mm W3:32.0mm PH:12mm  
 31~50PIN: DIM W1:20.2mm W2:40.4mm W3:44.0mm PH:12mm  
 2. 2000PCS/REEL

RoHS Compliant				PROJECTION: 	GENERAL TOLERANCE .X = $\pm 0.2$ .XX = $\pm 0.15$		DESCRIPTION: 0.5MM ZIF FPC HORIZONTAL TOP CONTACT TYPE - TAPE & REEL PACKAGING WERI PART NO: 6871 xx 14022	SIZE <b>A4</b>
G								
F								
E								
D								
C				APPROVAL: Gm0	UNIT: MM			
B					SCALE:			
A					SHEET: 2/3			
REV	DATE	FILE	BY		DRAW: QL			

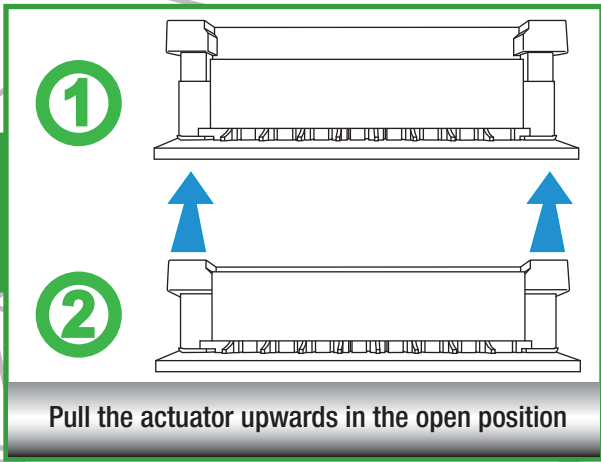

A

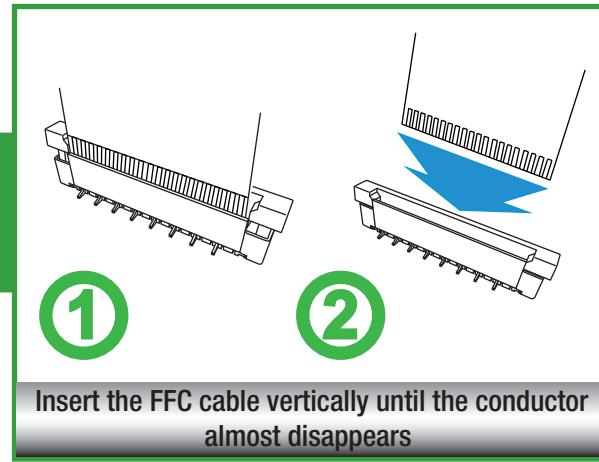

B

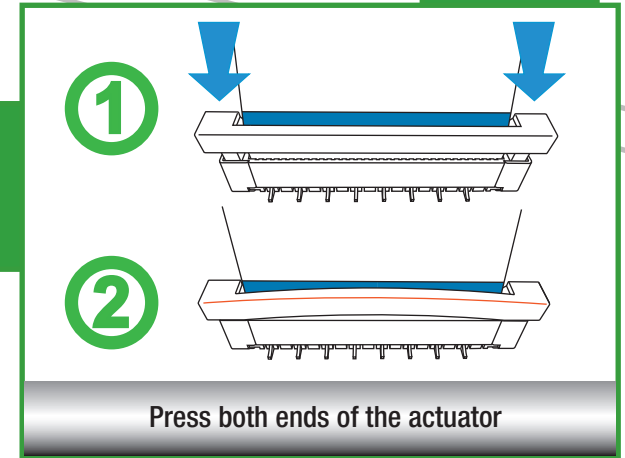
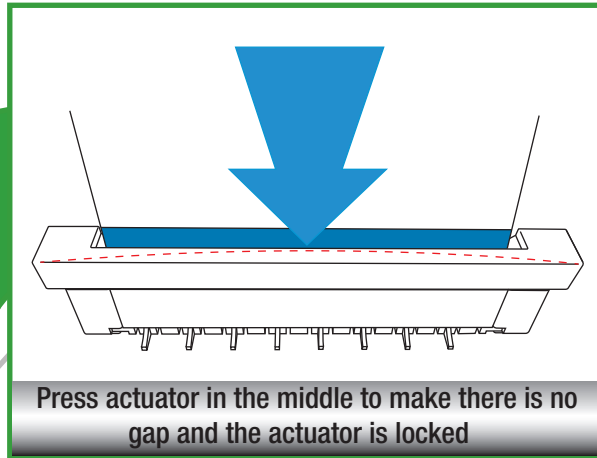

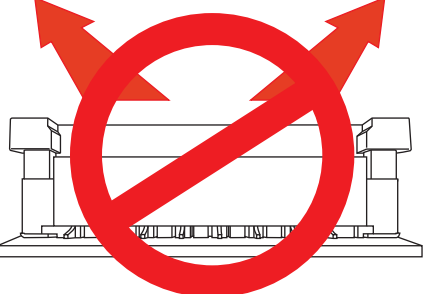

**Pull the actuator as horizontally as possible by a proper force**

**A**

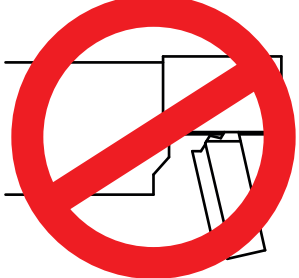

**Do not pull the actuator too far otherwise the stop limit (hook on actuator) may be broken**

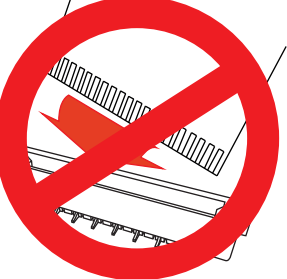

**Do not keep FFC inclined when insertion**

**B**

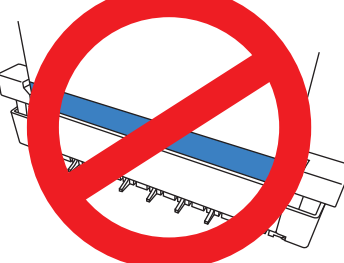

**Don't keep conductor toward actuator**