

Designed to comply with physical, electrical and environmental requirements of Micro USB Standard (USB2.0)
A/B types support USB On-The-GO (OTG) interface.

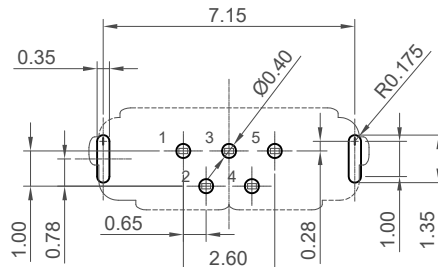

Recommended PCB Layout
As viewed from component side General Tolerance: ±0.05
□ Component Outline

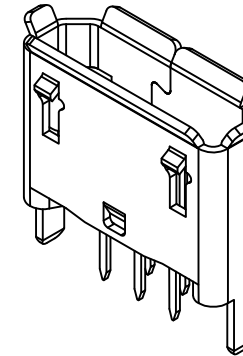
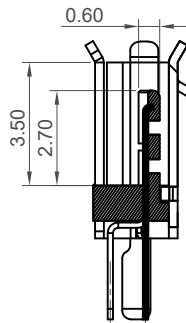

Section A:A

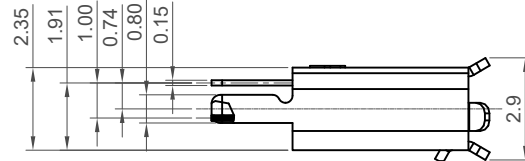

Ordering Grid
USB3131 - **30** - **0230** - **A** [Request Samples and Quotation](#)
 Contact Plating
 30 = 30µ" Gold
 Packing Options
 A = Tape & Reel
 (1,500 Pieces per Reel)
 Shell Stake Length "S"
 0230 = 2.30mm
 (recommended for 1.6mm PCB thickness)

Specifications 规格:

Materials 材料:

Plastic Housing 胶芯: LCP, UL94V-0, Black
 Contact Terminal 端子: Copper Alloy
 Metallic Shell 金属外壳: Stainless Steel SUS304-1/2H T=0.25mm

Plating 电镀:

Underplating 底层电镀: Nickel 50µ" min.
 Contact Area 接触区: 30µ" Gold plating
 Solder Tails 焊接区: Gold Flash
 Metallic Shell 金属外壳: Nickel 50-100µ"

Electrical 电气:

Voltage Rating 电压额定值: 30V
 Current Rating 电流额定值: Signal (Pins 2,3,4)信号: 1.0 A
 Power (Pins 1,5)电源: 1.8 A
 Operating Temperature 工作温度: -55°C to +85°C
 Contact Resistance 接触电阻值: 30 mΩ max.
 Insulating Resistance 绝缘电阻值: 1000 MΩ min.
 Dielectric Withstand Voltage 耐电压: 100V AC for 1 minute

Mechanical & Environmental 机械 & 环境

Mating Force 插入力: 35N max.
 Unmating Force 拨出力: Initial 10N min.
 Final 8N min after durability test.
 Durability 耐久性: 10,000 Cycles

Part Number		Product Description	
USB3131		Micro USB Receptacle, Type B, Through-Hole, Vertical, With 2.30mm (Standard) Shell Stakes	
Drawing Date		28th October 2013	
By	CC	Tolerances (Except as Noted)	Units:
Detail	USB3131 B PCN	Length	Metric (mm)
Revision	B3	Angle	3rd Angle Projection
Date	22/03/17		



This drawing is confidential and copyright of Global Connector Technology, Ltd (GCT). This drawing must not be copied or disclosed without written consent. E & OE



Not to Scale
 Drawn By AJO
 Sheet No. 1/2

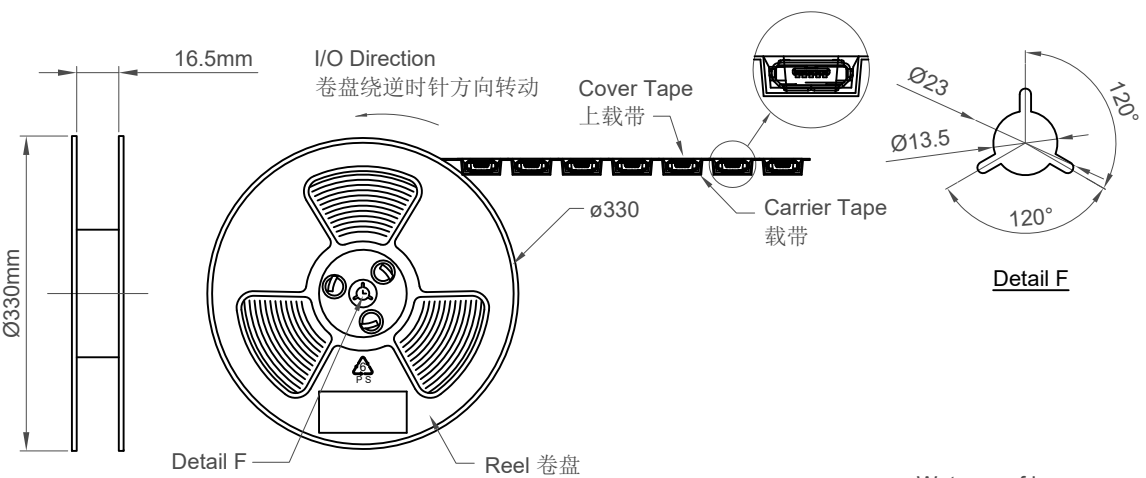
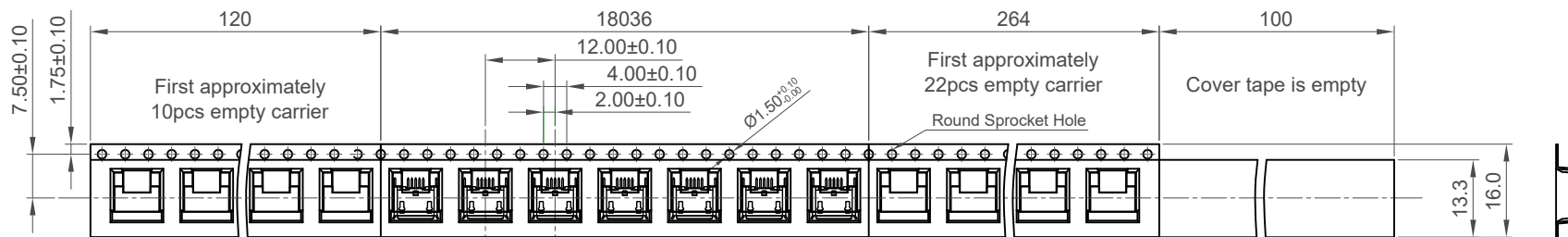

Products P/N	PCS/Reel	Reels/Carton	PCS/Carton
USB3131	1,500	10	15,000

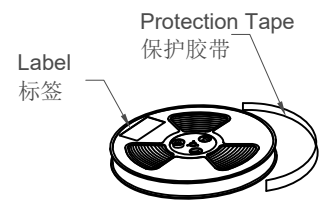

1,500 Pieces/Reel
1,500 件/卷

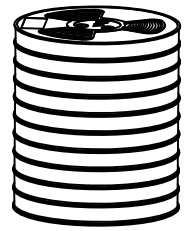

10 Reels
10 卷

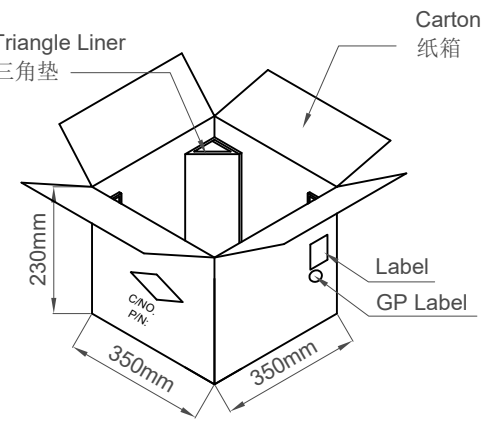
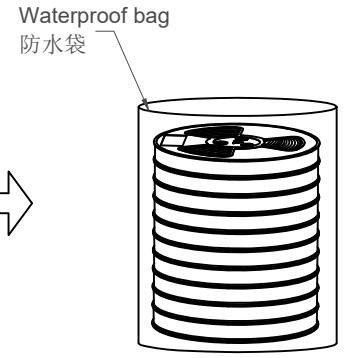

Part Number		Product Description	
USB3131		Micro USB Receptacle, Type B, Through-Hole, Vertical, With 2.30mm (Standard) Shell Stakes	
Drawing Date		28th October 2013	
By	CC	Tolerances (Except as Noted)	Units:
Detail	USB3131 B PCN	Length	Metric (mm)
Revision	B3	Angle	3rd Angle Projection
Date	22/03/17		



This drawing is confidential and copyright of Global Connector Technology, Ltd (GCT). This drawing must not be copied or disclosed without written consent. E & OE



Not to Scale Drawn By AJO Sheet No. 2/2