

SHAPE OF 4CKTS

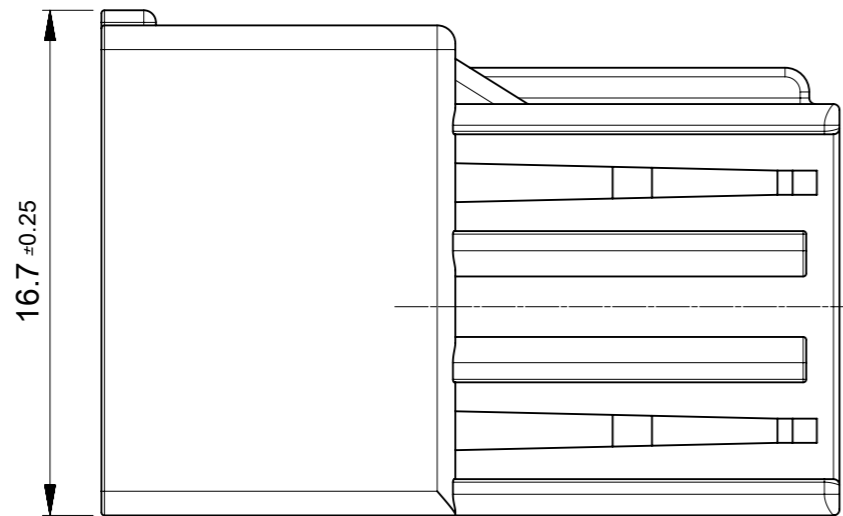

ターミナル嵌合状態図
TERMINAL MATING DRAWING

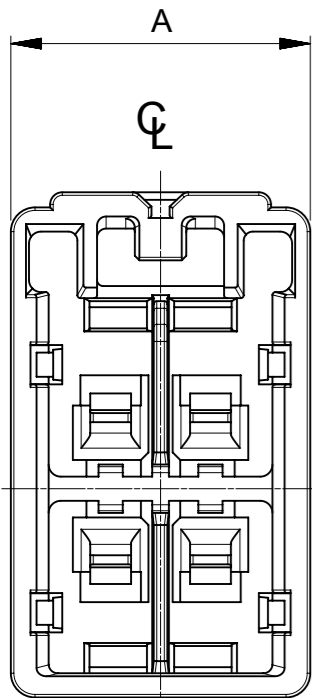
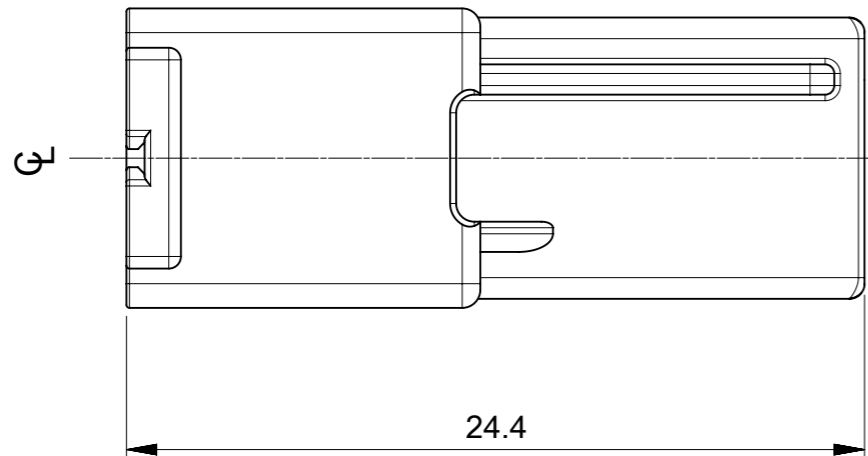
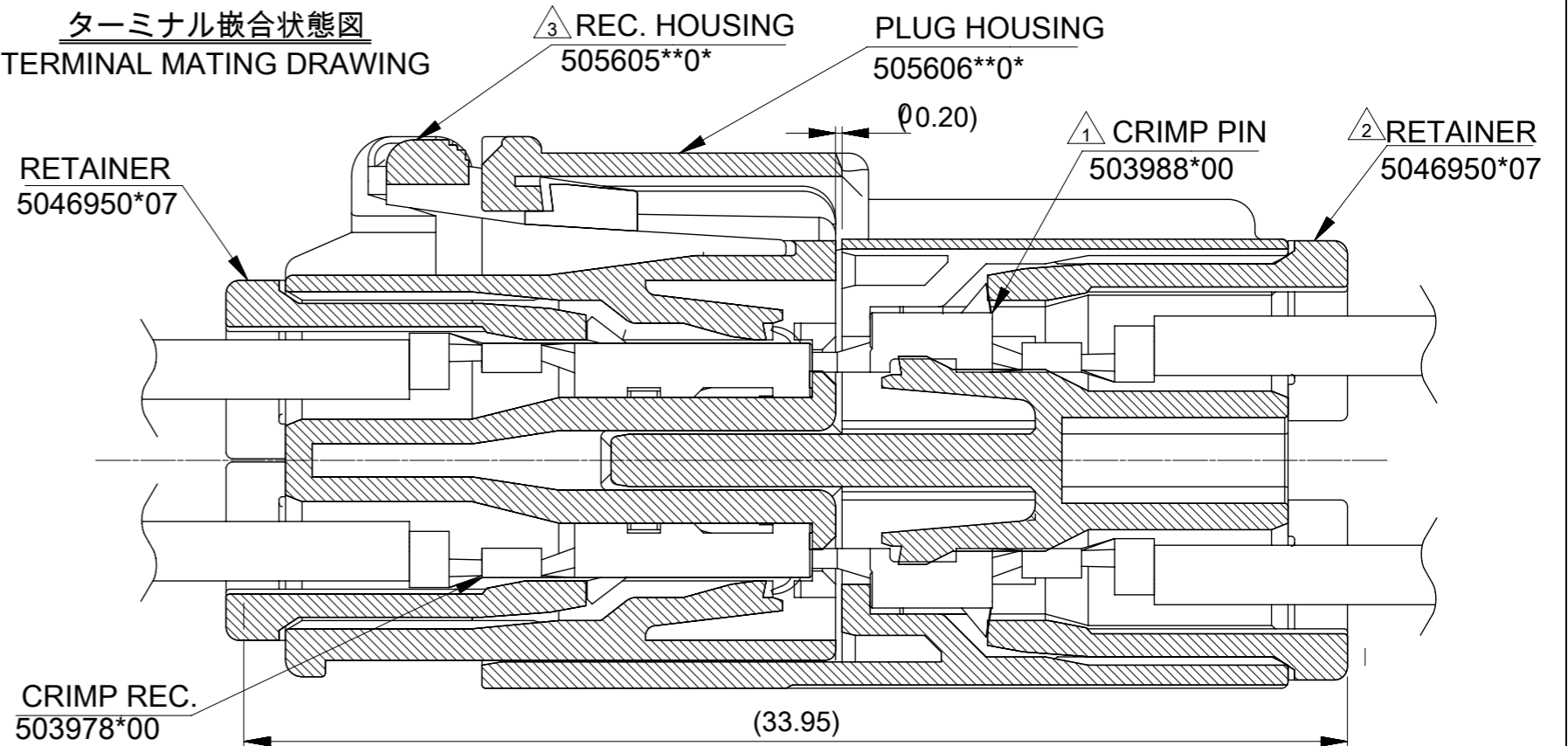

注記
NOTES

- △1 適合ターミナル:50398 シリーズ。
APPLICABLE TERMINAL: 50398 SERIES.
- △2 適合リテーナー : 504695 シリーズ。
APPLICABLE RETAINER:504695 SERIES.
- △3 嵌合相手:505605 シリーズ。
MATE WITH : 505605 SERIES.
- 4. 材質 : POLYESTER(PBT),UL94V-0
MATERIAL:POLYESTER(PBT),UL94V-0

5. MATERIAL NO. は以下の内容を示す。
MATERIAL NO.
505606 **0*

極数 CKT	色 COLOR
0	自然色 NATURAL
1	黒 BLACK
2	赤 RED
3	黄 YELLOW

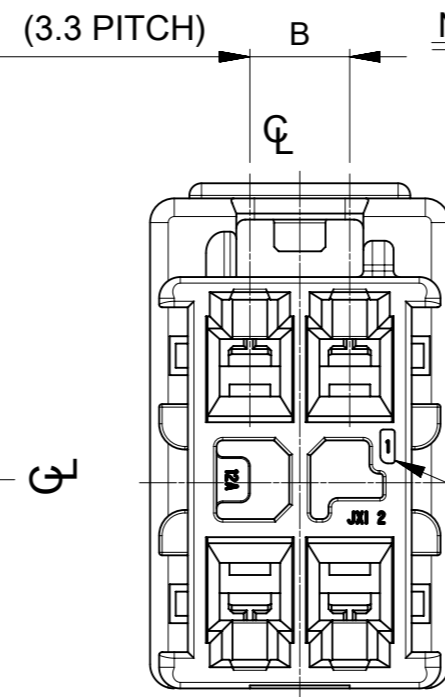

16.5	23.1	12	505606120*	505606**0*
13.2	19.8	10	505606100*	
9.9	16.5	8	505606080*	
6.6	13.2	6	505606060*	
3.3	9.9	4	505606040*	
(B)	A	極数 CKT.	BAG PACKAGE	MODEL NO.
			オーダー番号	ORDER NO.

THIS DRAWING CONTAINS INFORMATION THAT IS PROPRIETARY TO MOLEX ELECTRONIC TECHNOLOGIES, LLC AND SHOULD NOT BE USED WITHOUT WRITTEN PERMISSION

EC NO: 113316 DRWN: NITO CHK'D: SAKIYAMA APPR: TKANEKO	2017/02/08 2017/02/13 2017/02/13	GENERAL TOLERANCES (UNLESS SPECIFIED) ANGULAR TOL ± 3.0 ° 4 PLACES ± 0.2 3 PLACES ± 0.2 2 PLACES ± 0.2 1 PLACE ± 0.2 0 PLACES ± 0.2	DIMENSION UNITS: MM SCALE: 4:1 DRWN BY: QHE31 DATE: 2016/11/01 CHK'D BY: SAKIYAMA DATE: 2017/02/08 APPR BY: TKANEKO DATE: 2017/02/08	<p>CP 3.3 W/W DUAL ROW PLUG HOUSING</p> <p>PRODUCT CUSTOMER DRAWING</p>	
	DRAFT WHERE APPLICABLE MUST REMAIN WITHIN DIMENSIONS		DRAWING SIZE: A3 THIRD ANGLE PROJECTION		SERIES: 505606 MATERIAL NUMBER: 5056060000 CUSTOMER: GENERAL
			DOCUMENT NUMBER: 5056060000 DOC TYPE: PSD DOC PART: 000 SHEET NUMBER: 1 OF 2		

RELEASE STATUS	RELEASE DATE

MATING
KEY TYPE & COLOR

REFERENCE 4 CKTS

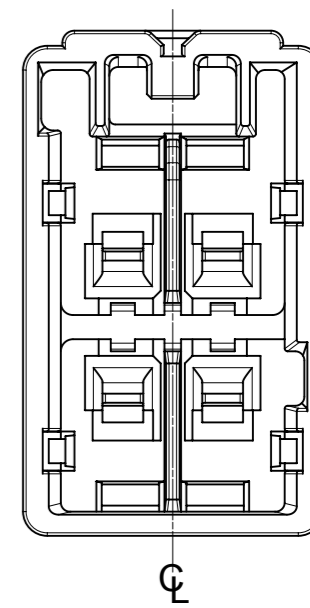
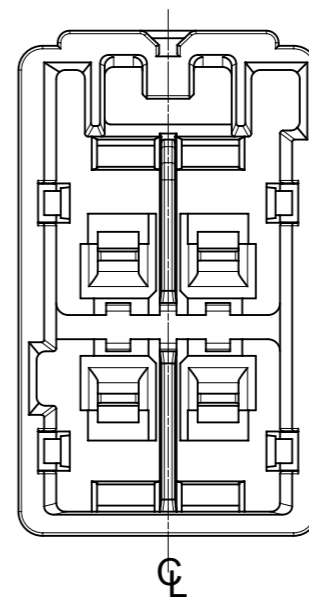
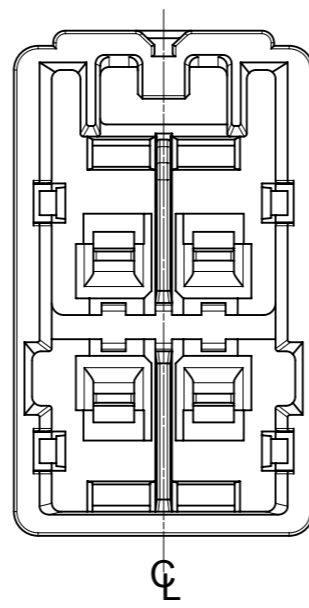
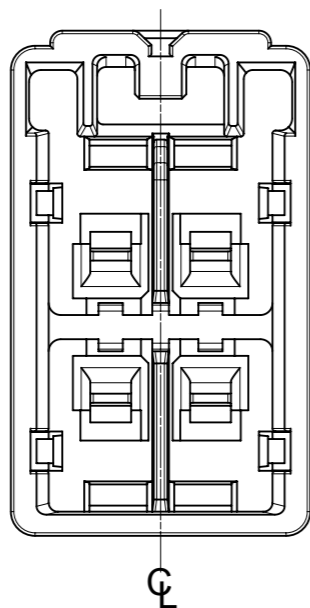

KEY TYPE : 1 COLOR : NATURAL
MATERIAL NO. : 5056060400

KEY TYPE : 2 COLOR : BLACK
MATERIAL NO. : 5056060401

KEY TYPE : 3 COLOR : RED
MATERIAL NO. : 5056060402

KEY TYPE : 4 COLOR : YELLOW
MATERIAL NO. : 5056060403

505605120*	5046950607	12	5056061203	5056061202	5056061201	5056061200
505605100*	5046950507	10	5056061003	5056061002	5056061001	5056061000
505605080*	5046950407	8	5056060803	5056060802	5056060801	5056060800
505605060*	5046950307	6				
505605040*	5046950207	4				
MATE WITH	CONFORTABLE-RETAINER	極数 CKT.	YELLOW	RED	BLACK	NATURAL
			BAG PACKAGE			
			オーダー番号 ORDER NO.			

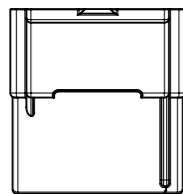
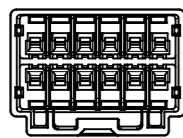

CKT1 MARK

VIEW OF 4,6,8,10,12CKTS
(SCALE 1:1)

THIS DRAWING CONTAINS INFORMATION THAT IS PROPRIETARY TO MOLEX ELECTRONIC TECHNOLOGIES, LLC AND SHOULD NOT BE USED WITHOUT WRITTEN PERMISSION

EC NO: 113316 DRWN: NITO CHK'D: SAKIYAMA APPR: TKANEKO	2017/02/08	GENERAL TOLERANCES (UNLESS SPECIFIED)	DIMENSION UNITS	SCALE				
	2017/02/13		MM	4:1				
	2017/02/13		ANGULAR TOL ± 3.0 °	DRWN BY		DATE		
			4 PLACES ± 0.2	QHE31		2016/11/01		
	3 PLACES ± 0.2		CHK'D BY	DATE	CP 3.3 W/W DUAL ROW PLUG HOUSING			
	2 PLACES ± 0.2	SAKIYAMA	2017/02/08					
	1 PLACE ± 0.2	TKANEKO	2017/02/08					
	0 PLACES ± 0.2		APPR BY	DATE	PRODUCT CUSTOMER DRAWING			
		DRAFT WHERE APPLICABLE MUST REMAIN WITHIN DIMENSIONS	DRAWING SIZE	THIRD ANGLE PROJECTION	SERIES	MATERIAL NUMBER	CUSTOMER	
			A3		505606	5056060000	GENERAL	
					DOCUMENT NUMBER	DOC TYPE	DOC PART	SHEET NUMBER
					5056060000	PSD	000	2 OF 2

RELEASE STATUS	RELEASE DATE
----------------	--------------