

This document is the property of Amphenol Corporation and is delivered on the express condition that it is not to be disclosed, reproduced or used, in whole or in part, for manufacture or sale by anyone other than Amphenol Corporation without its prior consent, and that no right is granted to disclose or to use any information in this document.  
The marking on this product doesn't contain environmental hazardous materials per Material Specification SS-00259 for Sony GP compliant or per directive 2011/65/EU for RoHS compliant.



ORIGINAL



| REVISIONS |          |                         |            |           |
|-----------|----------|-------------------------|------------|-----------|
| SYM       | ECN No.  | DESCRIPTION             | DATE       | APPROVED  |
| A         | NE-15011 | NON-RELEASE REVISION    | 01/23/2015 | Arron Lin |
| B         | NE-16190 | UPDATE PACKING QUANTITY | 08/22/2016 | Arron Lin |

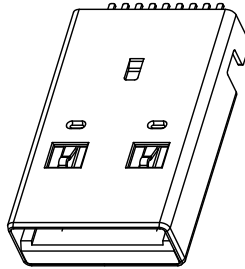
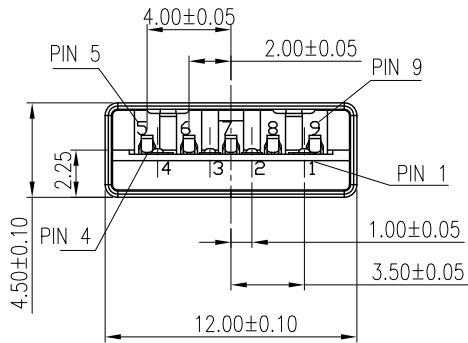
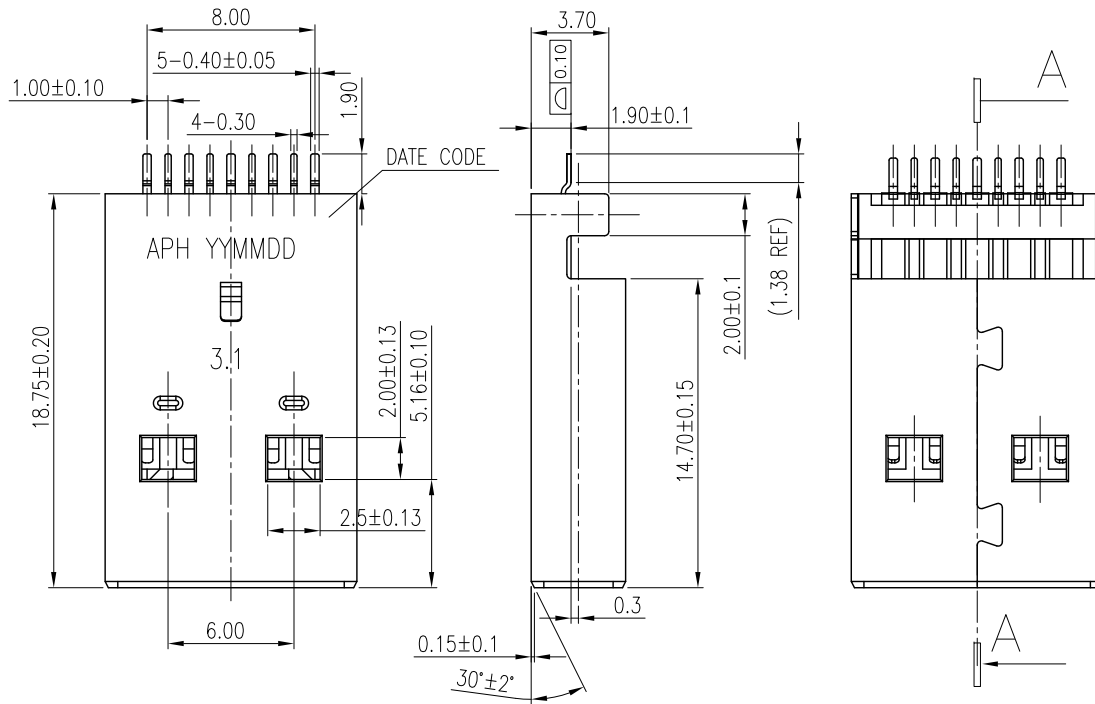

P/N : GSB4164 X 5 X HR  
CONTACT FINISH : 4: 30u" GOLD  
PACKING OPTIONS : C: T&R, 3: TRAY

- NOTES:
- MATERIAL:  
HOUSING: HIGH TEMPERATURE THERMAL PLASTIC LCP UL94-V0, COLOR: BLUE 300C.  
TERMINAL: COPPER ALLOY.  
SHIELD: SPCC.
  - FINISH:  
TERMINAL:  
CONTACT AREA: SELECTIVE PLATING;  
SOLDERING AREA: MATTE TIN PLATING 100 μ" THICKNESS MIN.;  
UNDER PLATING: NICKEL PLATING 50 μ" THICKNESS MIN. OVERALL.  
SHIELD:  
NICKEL PLATING 50 μ" THICKNESS MIN. OVERALL.
  - PACKING IS PER AMTA PACKING SPECIFICATION PKS-0001.
  - THIS PRODUCT DOESN'T CONTAIN ENVIRONMENTAL HAZARDOUS PER DIRECTIVE 2011/65/EU FOR RoHS COMPLIANT.
  - PRODUCT SPECIFICATION REFER TO : PS-7530.

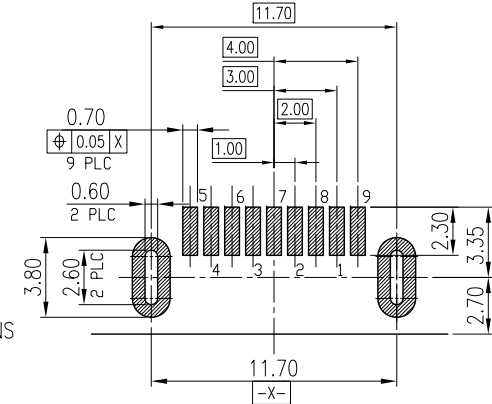

RECOMMEND P.C.B LAYOUT (THICKNESS=1.2mm)  
(COMPONENT SIDE) TOLERANCE

| TOLERANCE                  |       | APPROVALS |            | DATE         |            | TITLE   |  | Amphenol®   |  |              |      |
|----------------------------|-------|-----------|------------|--------------|------------|---|--|---|--|--------------|------|
| X.                         |       | DRAWN     | Debby Hung |              | 08/22/2016 | USB 3.1 A TYPE PLUG, SMT<br>0.3mm OFFSET CENTER LINE. |  | Amphenol Corporation<br>Amphenol Taiwan Corporation |  |              |      |
| X.X                        | ±0.30 | CHECKED   | Roger Tsai |              | 08/22/2016 |   |  |   |  |              |      |
| X.XX                       | ±0.20 | APPROVED  | Arron Lin  |              | 08/22/2016 |   |  |   |  |              |      |
| X.XXX                      | ±0.10 | DWG TYPE  |            | PROJECT CODE |            | UNIT  |  | SIZE  |  | PART No.     |      |
| ANGULAR                    | ±1°   | CUST DWG  |            | OTHER        |            | mm  |  | A3  |  | GSB4164X5XHR |      |
| UNLESS OTHERWISE SPECIFIED |       |           |            |              |            | SCALE   |  | SHEET   |  | DWG No.      | REV. |
|                            |       |           |            |              |            | NA  |  | 1 OF 3  |  | GSB4164X5XHR | B    |

This document is the property of Amphenol Corporation and is delivered on the express condition that it is not to be disclosed, reproduced or used, in whole or in part, for manufacture or sale by anyone other than Amphenol Corporation without its prior consent, and that no right is granted to disclose or to use any information in this document.

The marking on this product doesn't contain environmental hazardous materials per Material Specification 55-00259 for Sony GP compliant or per directive 2011/65/EU for RoHS compliant.



ORIGINAL



| REVISIONS |          |                         |            |           |
|-----------|----------|-------------------------|------------|-----------|
| SYM       | ECN No.  | DESCRIPTION             | DATE       | APPROVED  |
| A         | NE-15011 | NON-RELEASE REVISION    | 01/23/2015 | Arron Lin |
| B         | NE-16190 | UPDATE PACKING QUANTITY | 08/22/2016 | Arron Lin |

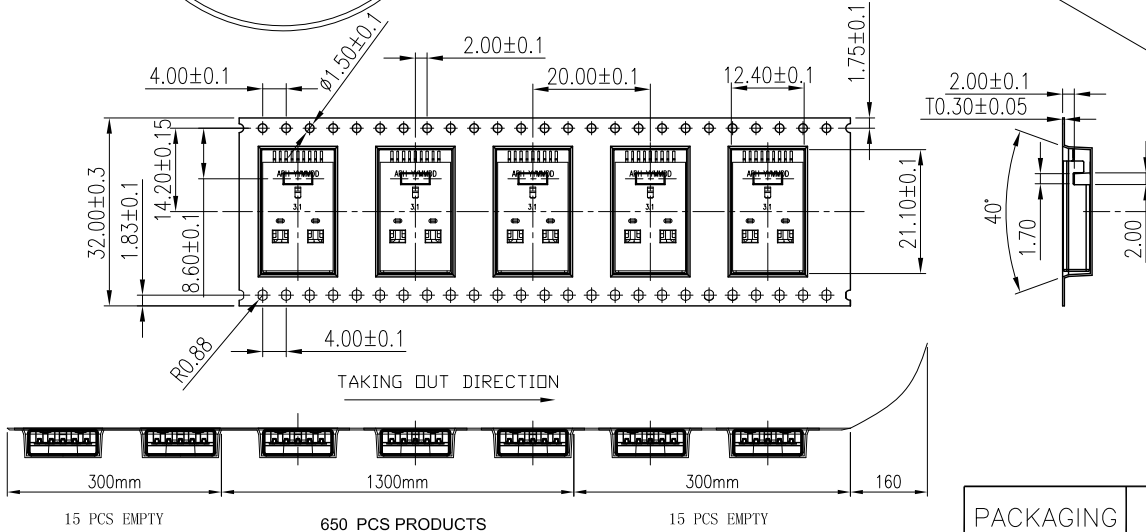
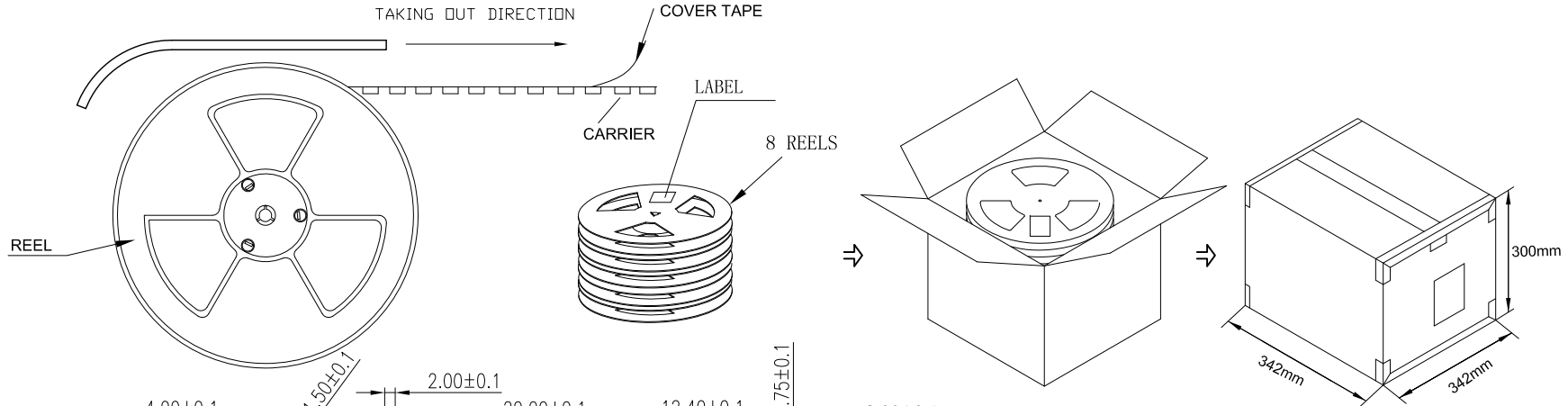

|                  |        |        |           |            |                |              |
|------------------|--------|--------|-----------|------------|----------------|--------------|
| PACKAGING BY T&R | 10.0   | 7.68   | 650       | 8          | 5200           | GSB4164X5CHR |
|                  | G/W KG | N/W KG | PCS/ REEL | REELS/ BOX | QUANTITY (PCS) | PART NUMBER  |

| TOLERANCE                  | APPROVALS          | DATE               | TITLE   |              | PART No.  |  |
|----------------------------|--------------------|--------------------|---|--------------|---|--|
| X. ±0.30                   | DRAWN Debby Hung   | 08/22/2016         | USB 3.0 A TYPE PLUG, SMT<br>0.3mm OFFSET CENTER LINE. |              | <b>Amphenol®</b><br>Amphenol Corporation<br>Amphenol Taiwan Corporation |  |
| X.X ±0.20                  | CHECKED Roger Tsai | 08/22/2016         |   |              |   |  |
| X.XXX ±0.10                | APPROVED Arron Lin | 08/22/2016         | UNIT mm   | SIZE A3      | PART No. GSB4164X5XHR   |  |
| ANGULAR ±1°                | DWG TYPE CUST DWG  | PROJECT CODE OTHER | SCALE NA  | SHEET 2 OF 3 | DWG No. GSB4164X5XHR REV. B   |  |
| UNLESS OTHERWISE SPECIFIED |                    |                    |   |              |   |  |

This document is the property of Amphenol Corporation and is delivered on the express condition that is not to be disclosed, reproduced or used, in whole or in part, for manufacture or sale by anyone other than Amphenol Corporation without its prior consent, and that no right is granted to disclose or to use any information in this document.

The marking on this product doesn't contain environmental hazardous materials per Material Specification SS-00259 for Sony GP compliant or per directive 2011/65/EU for RoHS compliant.



ORIGINAL



| REVISIONS |          |                         |            |           |
|-----------|----------|-------------------------|------------|-----------|
| SYM       | ECN No.  | DESCRIPTION             | DATE       | APPROVED  |
| A         | NE-15011 | NON-RELEASE REVISION    | 01/23/2015 | Arron Lin |
| B         | NE-16190 | UPDATE PACKING QUANTITY | 08/22/2016 | Arron Lin |

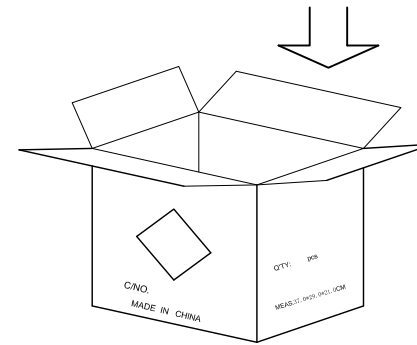
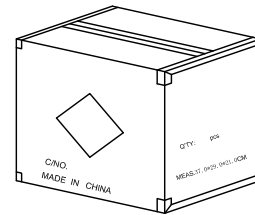
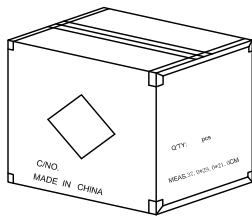
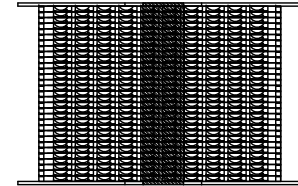
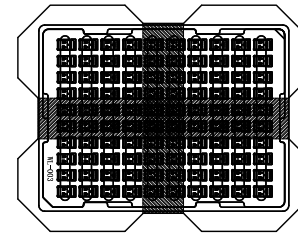
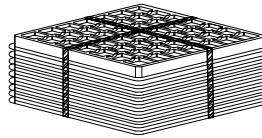
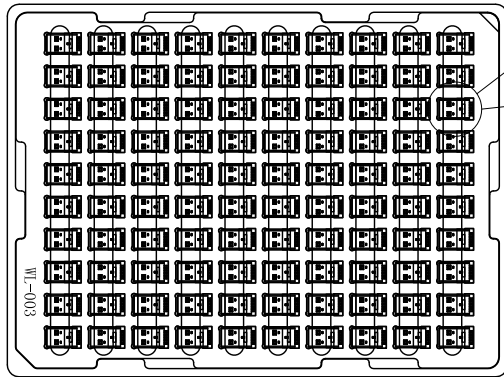

NOTES:  
1. CARTON SIZE: 370 X 290 X 210 mm

|                   |        |        |          |           |                |              |
|-------------------|--------|--------|----------|-----------|----------------|--------------|
| PACKAGING BY TRAY | 10     | 7.2    | 100      | 30        | 3000           | GSB4164X53HR |
|                   | G/W KG | N/W KG | PCS/TRAY | TRAYS/BOX | QUANTITY (PCS) | PART NUMBER  |

| TOLERANCE                  | APPROVALS          | DATE               |
|----------------------------|--------------------|--------------------|
| X. ±0.30                   | DRAWN Debby Hung   | 08/22/2016         |
| X.X ±0.20                  | CHECKED Roger Tsai | 08/22/2016         |
| X.XXX ±0.10                | APPROVED Arron Lin | 08/22/2016         |
| ANGULAR ±1°                | DWG TYPE CUST DWG  | PROJECT CODE OTHER |
| UNLESS OTHERWISE SPECIFIED |                    |                    |

TITLE  
USB 3.1 A TYPE PLUG, SMT  
0.3mm OFFSET CENTER LINE.

UNIT mm  
SCALE NA

SIZE A3  
SHEET 3 OF 3

**Amphenol®**  
Amphenol Corporation  
Amphenol Taiwan Corporation

PART No. GSB4164X5XHR  
DWG No. GSB4164X5XHR  
REV. B