

WiFIRE

Copyright 2014-2016, Digilent Inc.

Engineer: KRU

SHEET: ICSP, USB Serial, BTNs, LEDs

Author: GMA

TITLE: WiFIRE

Rev: D.0

Doc#: 500-302

Date: 7/21/2016

Sheet: 1/7

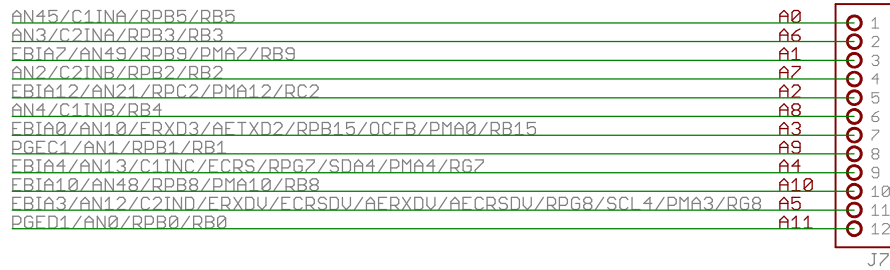
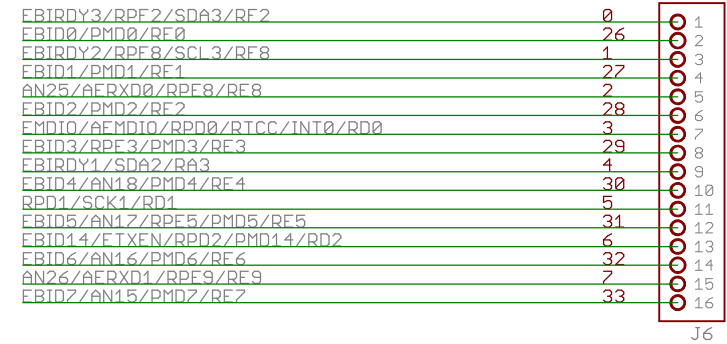
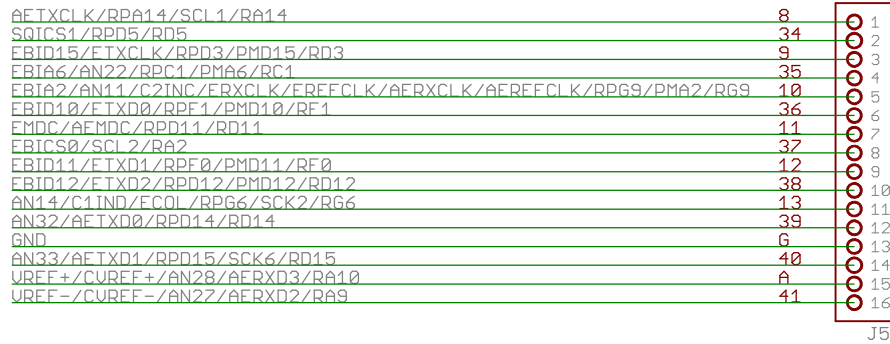
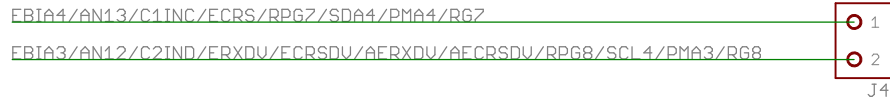

WiFIRE	
Copyright 2014-2016, Digilent Inc.	Engineer: KRU
SHEET: chipKit I/O connectors	Author: GMA
TITLE: WiFIRE	Rev: D.0
Doc#: 500-302	Date: 7/21/2016
	Sheet: 2/7

PORT A	
TMS/EBIA16/AN24/RA0	17
TCK/EBIA19/AN29/RA1	38
EBICS0/SCL2/RA2	59
EBIRDY1/SDA2/RA3	60
EBIA14/PMCS1/PMA14/RA4	61
EBIA5/AN34/PMA5/RA5	2
TRCLK/SQICLK/RA6	89
TRD3/SQID3/RA7	90
UREF-/CUREF-/AN27/AERXD2/RA9	28
UREF+/CUREF+/AN28/AERXD3/RA10	29
AETXCLK/RPA14/SCL1/RA14	66
AETXEN/RPA15/SDA1/RA15	67

TMS/EBIA16/AN24/RA0	17
TCK/EBIA19/AN29/RA1	38
EBICS0/SCL2/RA2	59
EBIRDY1/SDA2/RA3	60
EBIA14/PMCS1/PMA14/RA4	61
EBIA5/AN34/PMA5/RA5	2
TRCLK/SQICLK/RA6	89
TRD3/SQID3/RA7	90
UREF-/CUREF-/AN27/AERXD2/RA9	28
UREF+/CUREF+/AN28/AERXD3/RA10	29
AETXCLK/RPA14/SCL1/RA14	66
AETXEN/RPA15/SDA1/RA15	67

IC1PA

PORT B	
PGED1/AN0/RPB0/RB0	25
PGEC1/AN1/RPB1/RB1	24
AN2/C2INB/RPB2/RB2	23
AN3/C2INA/RPB3/RB3	22
AN4/C1INB/RB4	21
AN4/C1INB/RB4	20
AN45/C1INA/RPB5/RB5	26
PGEC2/AN46/RPB6/RB6	27
PGED2/AN47/RPB7/RB7	32
EBIA10/AN48/RPB8/PMA10/RB8	33
EBIA7/AN49/RPB9/PMA7/RB9	34
EBIA13/CUREFOUT/AN5/RPB10/PMA13/RB10	35
AN6/ERXERR/AETXERR/RB11	41
EBIA11/AN7/ERXD0/AECRS/PMA11/RB12	42
AN8/ERXD1/AECOL/RB13	43
EBIA1/AN9/ERXD2/AETXD3/RPB14/SCK3/PMA1/RB14	44
EBIA0/AN10/ERXD3/AETXD2/RPB15/OCFB/PMA0/RB15	

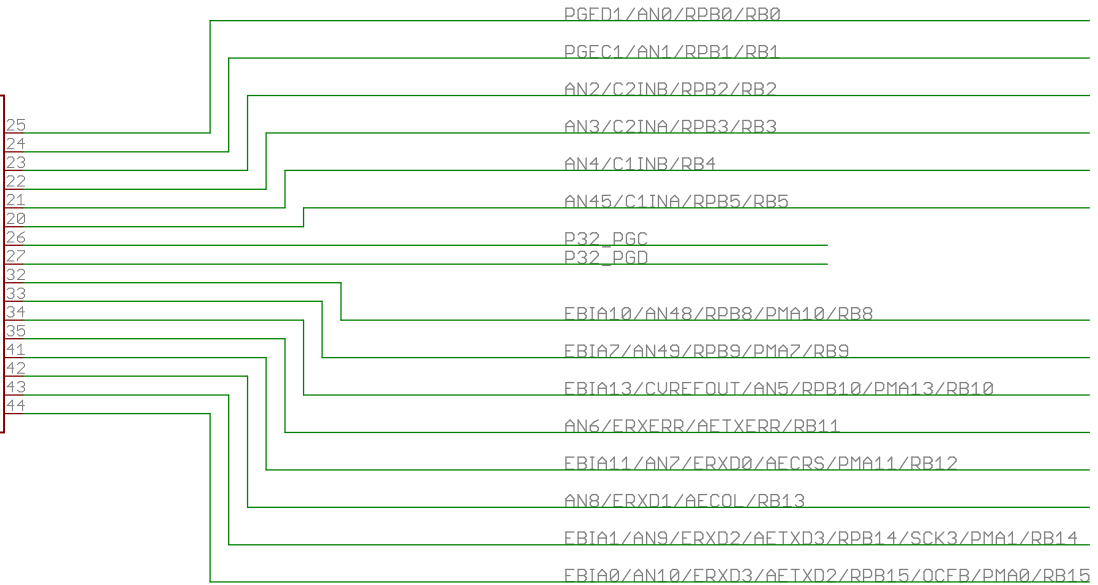

IC1PB

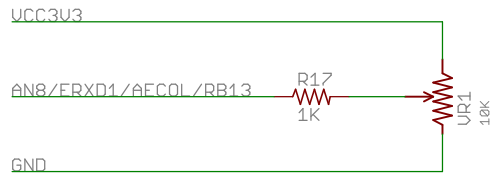

WiFIRE	
Copyright 2014-2016, Digilent Inc.	Engineer: KRU
SHEET: PIC32 I/O	Author: GMA
TITLE: WiFIRE	Rev: D.0
Doc#: 500-302	Date: 7/21/2016
	Sheet: 3/7

PORT D		
EMDIO/AEMDIO/RPD0/RTCC/INT0/RD0	71	FMDIO/AEMDIO/RPD0/RTCC/INT0/RD0
RPD1/SCK1/RD1	76	RPD1/SCK1/RD1
EBID14/ETXEN/RPD2/PMD14/RD2	77	EBID14/ETXEN/RPD2/PMD14/RD2
EBID15/ETXCLK/RPD3/PMD15/RD3	78	EBID15/ETXCLK/RPD3/PMD15/RD3
SQIC0/RPD4/RD4	81	SQIC0/RPD4/RD4
SQIC1/RPD5/RD5	82	SQIC1/RPD5/RD5
EBIA15/RPD9/PMCS2/PMA15/RD9	68	EBIA15/RPD9/PMCS2/PMA15/RD9
RPD10/SCK4/RD10	69	RPD10/SCK4/RD10
EMDC/AEMDC/RPD11/RD11	70	FMDC/AEMDC/RPD11/RD11
EBID12/ETXD2/RPD12/PMD12/RD12	79	EBID12/ETXD2/RPD12/PMD12/RD12
EBID13/ETXD3/PMD13/RD13	80	EBID13/ETXD3/PMD13/RD13
AN32/AETXD0/RPD14/RD14	47	AN32/AETXD0/RPD14/RD14
AN33/AETXD1/RPD15/SCK6/RD15	48	AN33/AETXD1/RPD15/SCK6/RD15

IC1PD

PORT E		
EBID0/PMD0/RE0	91	EBID0/PMD0/RE0
EBID1/PMD1/RE1	94	EBID1/PMD1/RE1
EBID2/PMD2/RE2	98	EBID2/PMD2/RE2
EBID3/RPE3/PMD3/RE3	99	EBID3/RPE3/PMD3/RE3
EBID4/AN18/PMD4/RE4	100	EBID4/AN18/PMD4/RE4
EBID5/AN17/RPE5/PMD5/RE5	3	EBID5/AN17/RPE5/PMD5/RE5
EBID6/AN16/PMD6/RE6	4	EBID6/AN16/PMD6/RE6
EBID7/AN15/PMD7/RE7	5	EBID7/AN15/PMD7/RE7
AN25/AERXD0/RPE8/RE8	18	AN25/AERXD0/RPE8/RE8
AN26/AERXD1/RPE9/RE9	19	AN26/AERXD1/RPE9/RE9

IC1PE

PORT F		
EBID11/ETXD1/RPF0/PMD11/RF0	85	EBID11/ETXD1/RPF0/PMD11/RF0
EBID10/ETXD0/RPF1/PMD10/RF1	86	EBID10/ETXD0/RPF1/PMD10/RF1
EBIRDY3/RPF2/SDA3/RF2	57	EBIRDY3/RPF2/SDA3/RF2
USBID/RPF3/RF3	56	USBID/RPF3/RF3
EBIA9/RPF4/SDA5/PMA9/RF4	64	EBIA9/RPF4/SDA5/PMA9/RF4
EBIA8/RPF5/SCL5/PMA8/RF5	65	EBIA8/RPF5/SCL5/PMA8/RF5
EBIRDY2/RPF8/SCL3/RF8	58	EBIRDY2/RPF8/SCL3/RF8
TDO/EBIA17/AN31/RPF12/RF12	40	TDO/EBIA17/AN31/RPF12/RF12
TDI/EBIA18/AN30/RPF13/SCK5/RF13	39	TDI/EBIA18/AN30/RPF13/SCK5/RF13

IC1PF

PORT G		
EBID8/RPG0/PMD8/RG0	88	EBID8/RPG0/PMD8/RG0
EBID9/ETXERR/RPG1/PMD9/RG1	87	EBID9/ETXERR/RPG1/PMD9/RG1
AN14/C1IND/ECOL/RPG6/SCK2/RG6	10	AN14/C1IND/ECOL/RPG6/SCK2/RG6
EBIA4/AN13/C1INC/ECRS/RPG7/SDA4/PMA4/RG7	11	EBIA4/AN13/C1INC/ECRS/RPG7/SDA4/PMA4/RG7
EBIA3/AN12/C2IND/ERXDU/ECRSDU/AECRSDU/RPG8/SCL4/PMA3/RG8	12	EBIA3/AN12/C2IND/ERXDU/ECRSDU/AECRSDU/RPG8/SCL4/PMA3/RG8
EBIA2/AN11/C2INC/ERXCLK/EREFCLK/RPG9/PMA2/RG9	16	EBIA2/AN11/C2INC/ERXCLK/EREFCLK/AERXCLK/AEREFCLK/RPG9/PMA2/RG9
TRD1/SQID1/RG12	96	TRD1/SQID1/RG12
TRD0/SQID0/RG13	97	TRD0/SQID0/RG13
TRD2/SQID2/RG14	95	TRD2/SQID2/RG14
AN23/AERXERR/RG15	1	AN23/AERXERR/RG15

IC1PG

PORT C		
EBIA6/AN22/RPC1/PMA6/RC1	6	EBIA6/AN22/RPC1/PMA6/RC1
EBIA12/AN21/RPC2/PMA12/RC2	7	EBIA12/AN21/RPC2/PMA12/RC2
EBIAE/AN20/RPC3/PMWR/RC3	8	EBIAE/AN20/RPC3/PMWR/RC3
EBIOE/AN19/RPC4/PMRD/RC4	9	EBIOE/AN19/RPC4/PMRD/RC4
OSCI/CLKI/RC12	49	PIC32_24MHZ
SOSCI/RPC13/RC13	72	
SOSCO/RPC14/T1CK/RC14	73	
OSCO/CLKO/RC15	50	

IC1PC

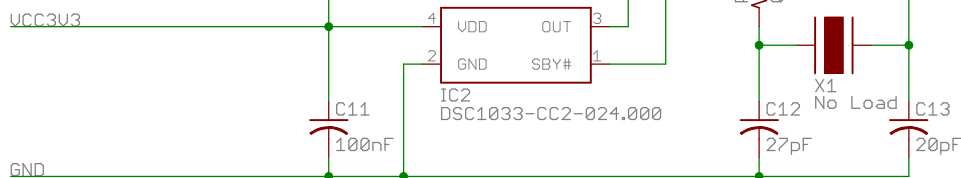

WiFIRE	
Copyright 2014-2016, Digilent Inc.	
Engineer: KRU	
SHEET: PIC32 I/0	Author: GMA
TITLE: WiFIRE	Rev: D.0
Doc#: 500-302	Date: 7/21/2016
	Sheet: 4/7

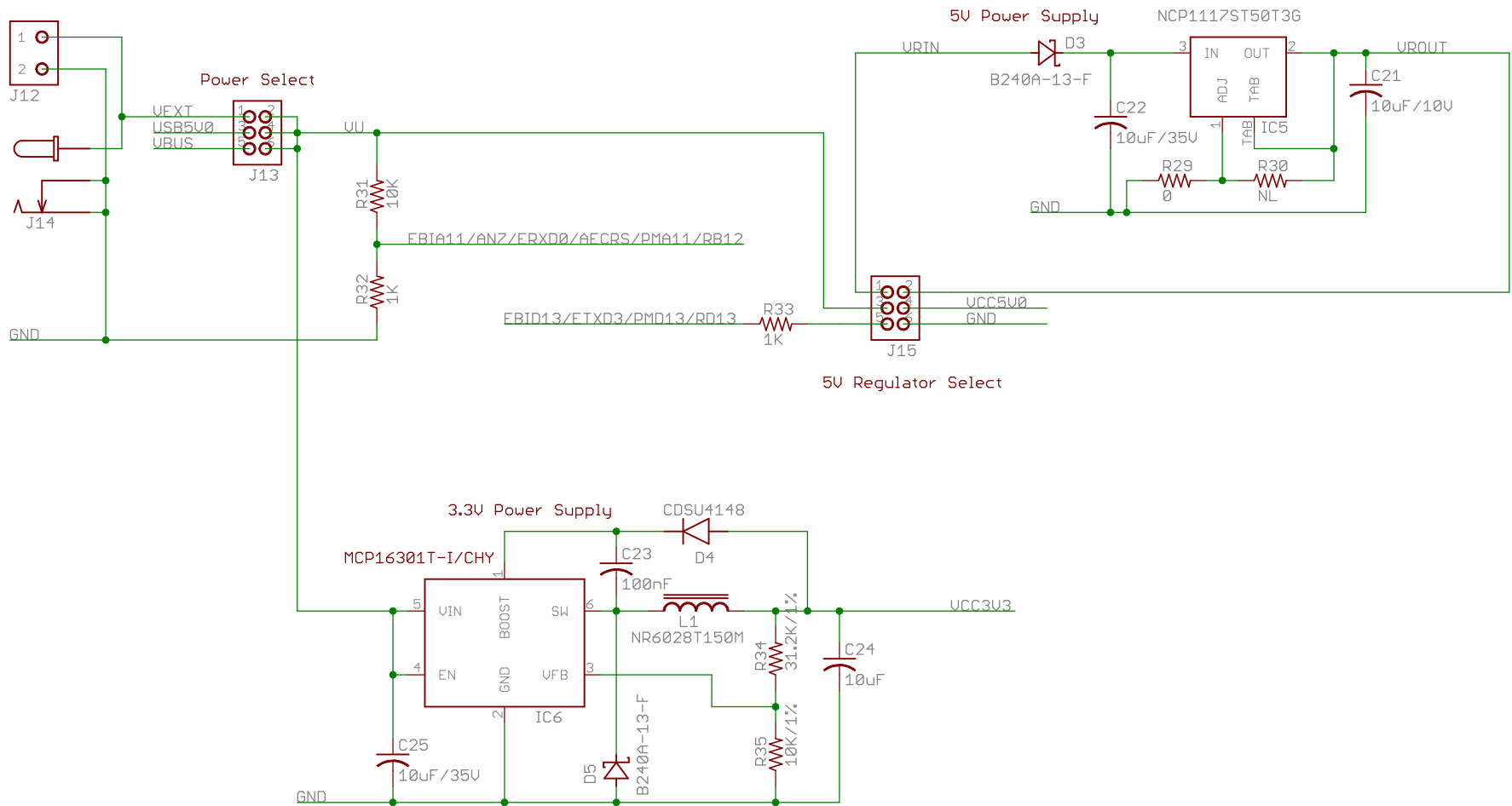

WiFIRE		Engineer: KRU
Copyright 2014-2016, Digilent Inc.		Author: GMA
SHEET: Power Supplies		Rev: D.0
TITLE: WiFIRE		Date: 7/21/2016
Doc#: 500-302	Date: 7/21/2016	Sheet: 6/7

