

THIS DRAWING IS UNPUBLISHED. RELEASED FOR PUBLICATION 20
 © COPYRIGHT 20 BY - ALL RIGHTS RESERVED.

REVISIONS

P	LTR	DESCRIPTION	DATE	DWN	APVD
	A	INITIAL RELEASE	29AUG2017	YC	CW

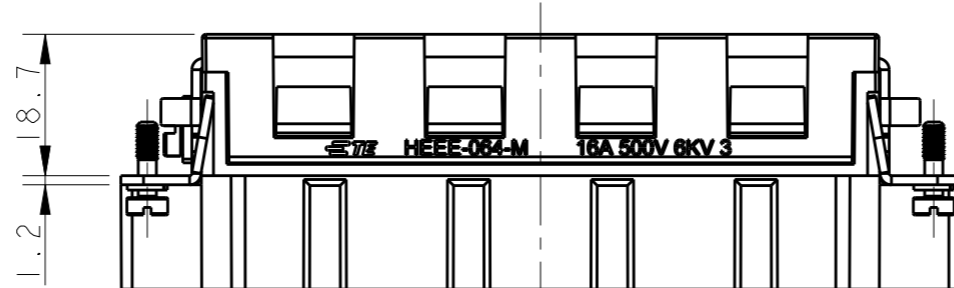
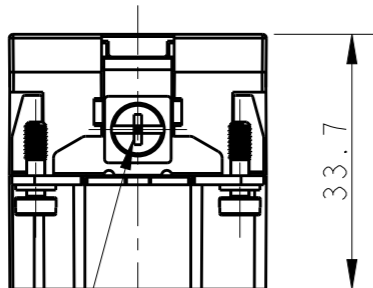
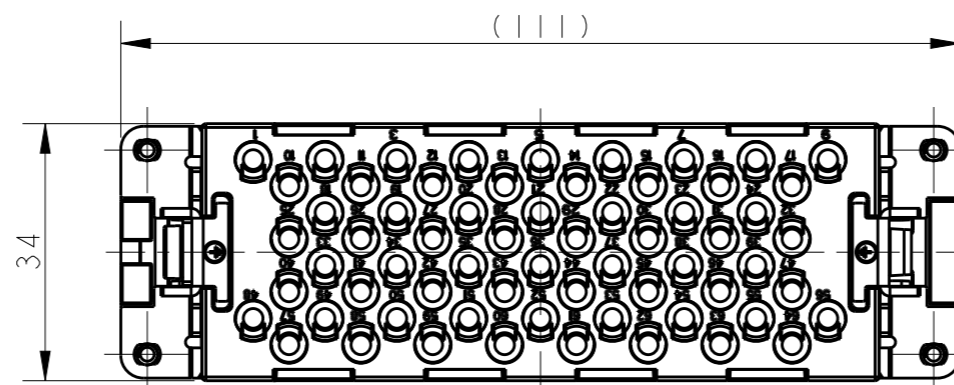
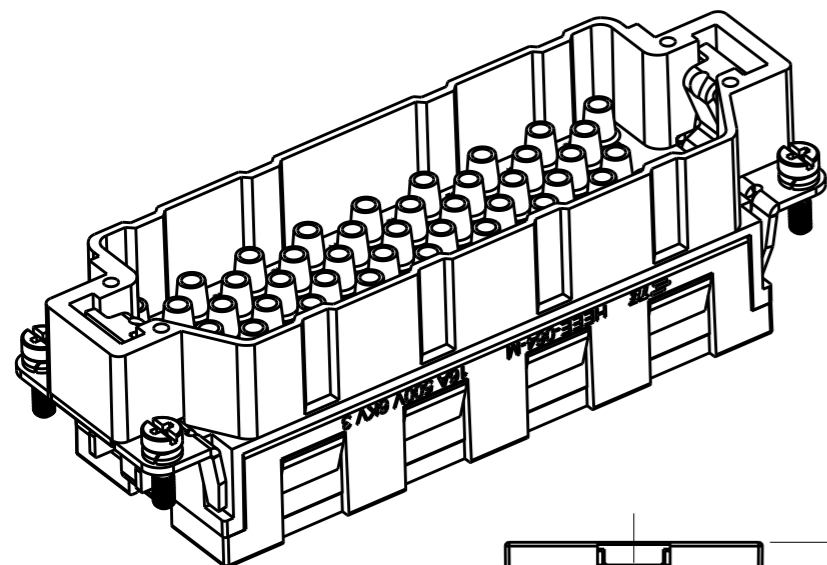

M4 SCREW, RECOMMENDED TIGHTENING TORQUE 1.2N.m
 M4 螺丝, 推荐拧紧力矩1.2N.m

4X M3 SCREW, RECOMMENDED TIGHTENING TORQUE 0.5N.m
 4X M3 螺丝, 推荐拧紧力矩0.5N.m

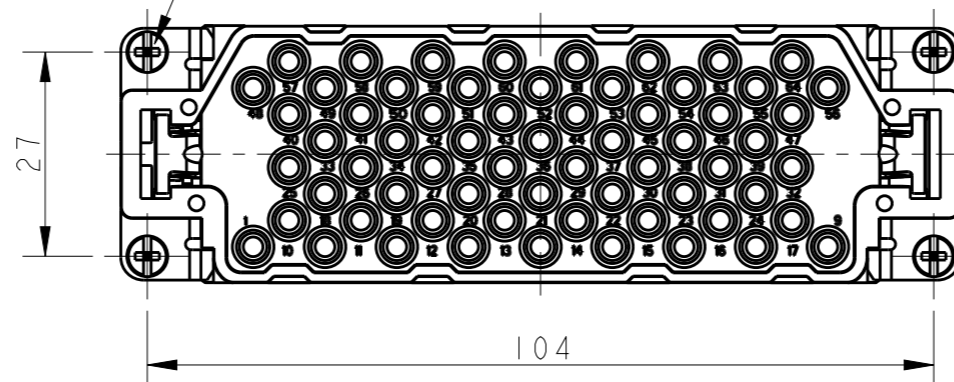

NOTES:

- TECHNICAL CHARACTERISTICS:
 INSULATION MATERIAL: PC
 RATED VOLTAGE: 500V
 RATED CURRENT: 16A
 INSULATION RESISTANCE: $\geq 400M\Omega$
 RATED IMPULSE VOLTAGE: 6KV
 POLLUTION DEGREE: 3
 FLAMMABILITY: UL94V-0
 MATING CYCLES: 500 CYCLES
 WIRE RANGE: $0.14mm^2 \sim 4mm^2$ (AWG26-AWG12)
 CONTACT TYPE: CRIMP CONTACT
- CONTACTS NEED TO BE ORDERED SEPARATELY.
 (ORDER No. REFER TO DRAWING: T20300X10XX000)

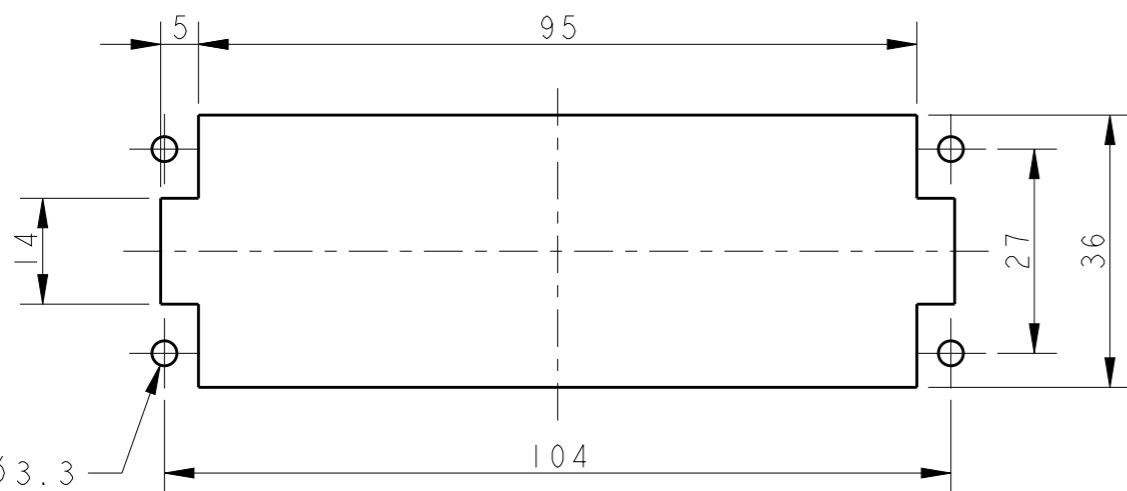

注释:

- 技术参数:
 绝缘材料: PC
 额定电压: 500V
 额定电流: 16A
 绝缘电阻: $\geq 400M\Omega$
 脉冲电压: 6KV
 污染等级: 3
 阻燃等级: UL94V-0
 插拔次数: 500次
 接线范围: $0.14mm^2 \sim 4mm^2$ (AWG26-AWG12)
 接线类型: 冷压接
- 端子需要单独订购.
 (订货号参考图面: T20300X10XX000)



PANEL CUT FOR INSERTS FOR USE WITHOUT HOODS/ HOUSINGS
 不使用防护外壳时芯件安装平面开孔图

T2050643101-007	HEEE-064-M	HEEE-064 MALE INSERT HEEE-064 公插
PART NUMBER 料号	PART DESCRIPTION 产品描述	

THIS DRAWING IS A CONTROLLED DOCUMENT.		DWN 29AUG2017 YORK CHEN		 TE Connectivity	
DIMENSIONS: mm		TOLERANCES UNLESS OTHERWISE SPECIFIED:			
		0 PLC ±- 1 PLC ±- 2 PLC ±- 3 PLC ±- 4 PLC ANGLES ±-		NAME HEEE-064-M	
MATERIAL		FINISH		PRODUCT SPEC 108-137068	
-		-		APPLICATION SPEC 114-137068	
-		-		WEIGHT -	
CUSTOMER DRAWING		SCALE 1:1		SIZE A3 00779 CAGE CODE T2050643101007	
		SHEET 1 OF 1		RESTRICTED TO -	
				REV A	