

THIS DRAWING IS UNPUBLISHED. RELEASED FOR PUBLICATION 20
 © COPYRIGHT 20 BY - ALL RIGHTS RESERVED.

REVISIONS

P	LTR	DESCRIPTION	DATE	DWN	APVD
	A	INITIAL RELEASE	29AUG2017	YC	CW

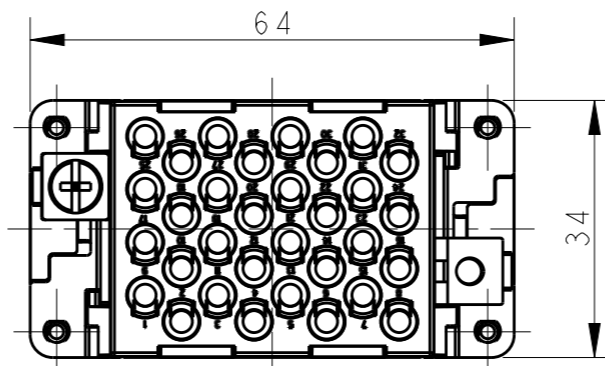
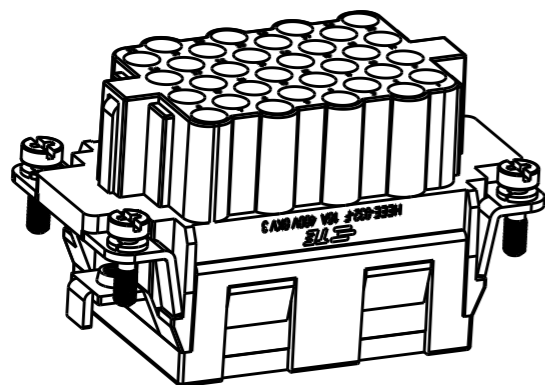

NOTES:

- TECHNICAL CHARACTERISTICS:
 INSULATION MATERIAL: PC
 RATED VOLTAGE: 400V
 RATED CURRENT: 16A
 INSULATION RESISTANCE: $\geq 400M\Omega$
 RATED IMPULSE VOLTAGE: 6KV
 POLLUTION DEGREE: 3
 FLAMMABILITY: UL94V-0
 MATING CYCLES: 500 CYCLES
 WIRE RANGE: $0.14mm^2 \sim 4mm^2$ (AWG26-AWG12)
 CONTACT TYPE: CRIMP CONTACT
- CONTACTS NEED TO BE ORDERED SEPARATELY.
 (ORDER No. REFER TO DRAWING: T20300X20XX000)

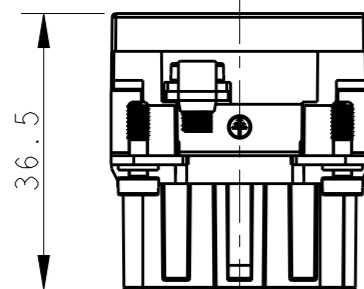

M4 SCREW, RECOMMENDED
 TIGHTENING TORQUE 1.2N.m
 M4 螺丝, 推荐拧紧力矩 1.2N.m

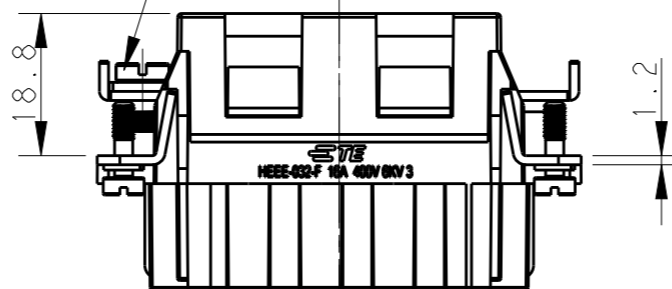

注释:

- 技术参数:
 绝缘材料: PC
 额定电压: 400V
 额定电流: 16A
 绝缘电阻: $\geq 400M\Omega$
 脉冲电压: 6KV
 污染等级: 3
 阻燃等级: UL94V-0
 插拔次数: 500次
 接线范围: $0.14mm^2 \sim 4mm^2$ (AWG26-AWG12)
 接线类型: 冷压接
- 端子需要单独订购,
 (订货号参考图面: T20300X20XX000)

4X M3 SCREW, RECOMMENDED
 TIGHTENING TORQUE 0.5N.m
 4X M3 螺丝, 推荐拧紧力矩 0.5N.m

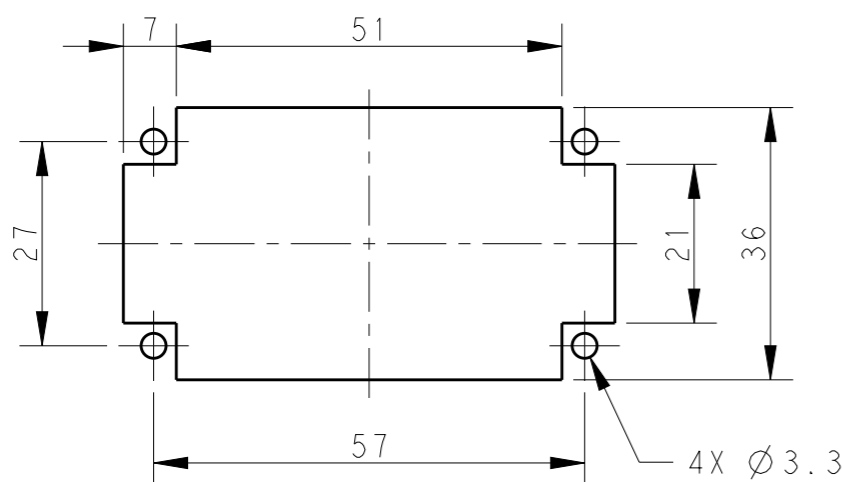
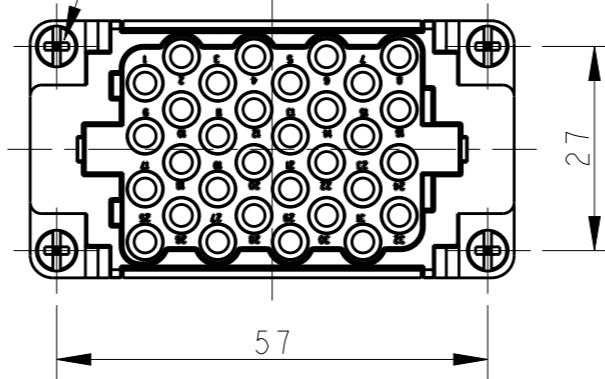

PANEL CUT FOR INSERTS FOR USE
 WITHOUT HOODS/ HOUSINGS
 不使用防护外壳时芯件安装平面开孔图

T2050323201-007	HEEE-032-F	HEEE-032 FEMALE INSERT HEEE-032 母插
PART NUMBER 料号	PART DESCRIPTION 产品描述	

THIS DRAWING IS A CONTROLLED DOCUMENT.		DWN 29AUG2017 YORK CHEN	 TE Connectivity	
DIMENSIONS: mm		CHK 29AUG2017 GINO YAO		
TOLERANCES UNLESS OTHERWISE SPECIFIED:		APVD 29AUG2017 CHRIS WANG	NAME HEEE-032-F	
0 PLC ±-		PRODUCT SPEC 108-137068	SIZE A3	
1 PLC ±-		APPLICATION SPEC 114-137068	CAGE CODE 00779	DRAWING NO T2050323201007
2 PLC ±-		WEIGHT -	RESTRICTED TO -	
3 PLC ±-		CUSTOMER DRAWING	SCALE 1:1	SHEET 1 OF 1
4 PLC ±-			REV A	
ANGLES ±-				
FINISH -				
MATERIAL -				