

LOC	DIST	REVISIONS			
P	LTN	DESCRIPTION	DATE	OWN	APVD
A		FIRST RELEASE	10AUG2016	SZ	SZ

- MATERIAL: HOUSING - THERMOPLASTIC, GLASS REINFORCED, COLOR: BLACK  
CONTACT - COPPER ALLOY
- FINISH: CONTACT - GOLD PLATED OVER NICKEL  
SOLDER TAILS - MATTE TIN OVER NICKEL
- CONNECTOR ASSEMBLY MARKED WITH PART NUMBER AND DATE CODE IN THE APPROXIMATE AREA SHOWN
- DATUMS AND BASIC DIMENSIONS TO BE ESTABLISHED BY CUSTOMER
- MANUFACTURING TOLERANCE FOR 1.07mm DIAMETER FINISHED HOLE:  
DRILLED HOLE = 1.15+/-0.03mm  
COPPER PLATE = 0.050/0.025mm (MAX HARDNESS 150 KNOOP)  
TIN/LEAD PLATE (HASL) = 0.010/0.004mm
- MANUFACTURING TOLERANCE FOR 0.70mm DIAMETER FINISHED HOLE:  
DRILLED HOLE = 0.78+/-0.03mm  
COPPER PLATE = 0.050/0.025mm (MAX HARDNESS 150 KNOOP)  
TIN/LEAD PLATE (HASL) = 0.010/0.004mm

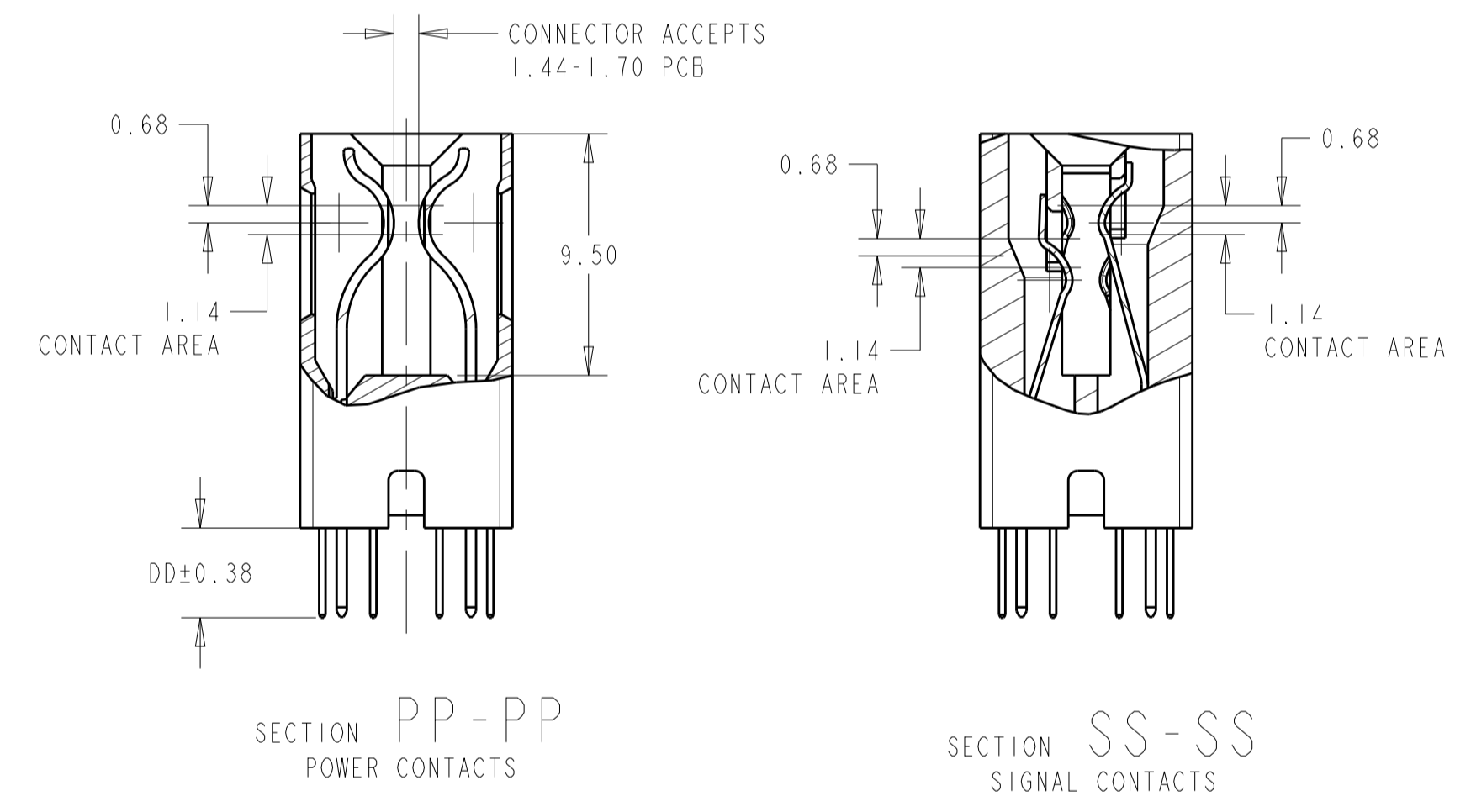

2214934-1 SHOWN

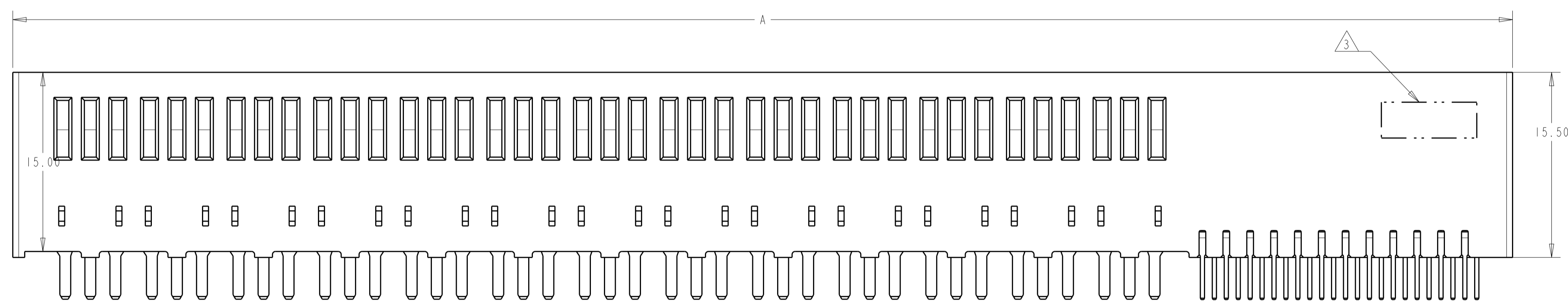
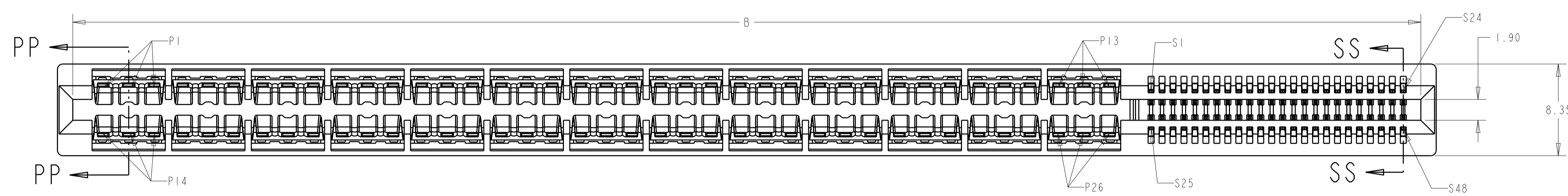
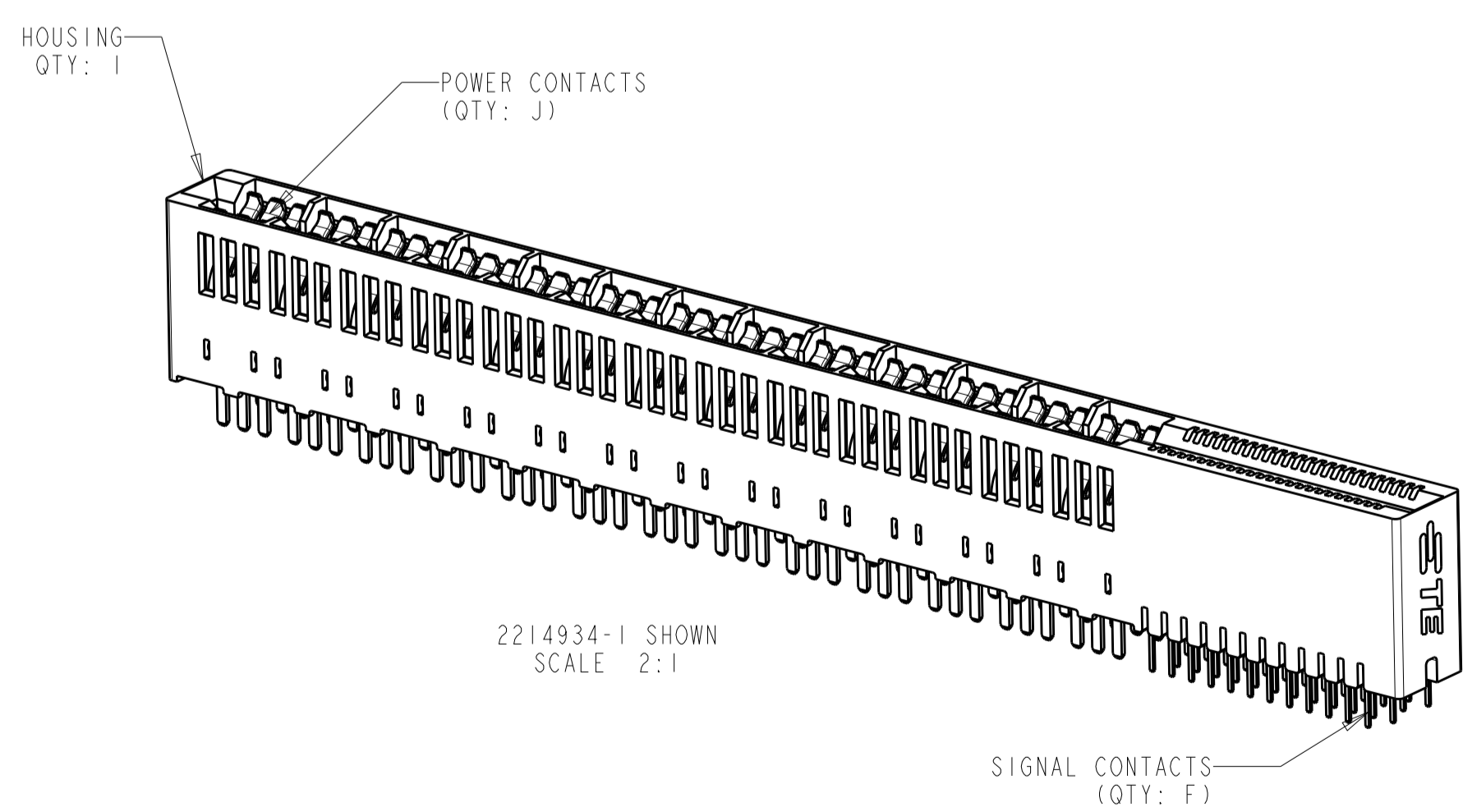

2214934-1 SHOWN  
SCALE 2:1

2.92	3.50	7.44	24.76	6	10.93	4.41	4	18.37	8	12	10	12	2	25.07	27.87	2 X 2 POWER 2 X 6 SIGNAL	1-2214934-4
2.92	3.50	1.81	13.50	2	5.30	2.78	2	7.11	4	4	2	6	0	13.81	16.61	2 X 1 POWER 2 X 2 SIGNAL	1-2214934-3
2.92	3.50	12.44	34.76	16	15.93	-0.59	4	28.37	8	32	30	12	2	35.07	37.87	2 X 2 POWER 2 X 16 SIGNAL	1-2214934-2
2.92	3.50	23.70	57.28	24	31.22	6.70	8	50.89	16	48	46	24	6	57.59	60.39	2 X 4 POWER 2 X 24 SIGNAL	1-2214934-1
2.92	3.50	10.44	30.76	12	13.93	1.41	4	24.37	8	24	22	12	2	31.07	33.87	2 X 2 POWER 2 X 12 SIGNAL	2214934-9
4.45	5.00	24.96	59.80	12	28.45	15.93	12	53.41	24	24	22	36	10	60.11	62.91	2 X 6 POWER 2 X 12 SIGNAL	2214934-8
2.92	3.50	24.96	59.80	12	28.45	15.93	12	53.41	24	24	22	36	10	60.11	62.91	2 X 6 POWER 2 X 12 SIGNAL	2214934-7
4.45	5.00	15.70	41.28	8	19.19	10.67	8	34.89	16	16	14	24	6	41.59	44.39	2 X 4 POWER 2 X 8 SIGNAL	2214934-6
2.92	3.50	15.70	41.28	8	19.19	10.67	8	34.89	16	16	14	24	6	41.59	44.39	2 X 4 POWER 2 X 8 SIGNAL	2214934-5
4.45	5.00	6.44	22.76	4	9.93	5.41	4	16.37	8	8	6	12	2	23.07	25.87	2 X 2 POWER 2 X 4 SIGNAL	2214934-4
2.92	3.50	6.44	22.76	4	9.93	5.41	4	16.37	8	8	6	12	2	23.07	25.87	2 X 2 POWER 2 X 4 SIGNAL	2214934-3
4.45	5.00	56.37	122.62	24	59.86	35.34	26	116.23	52	48	46	78	24	122.93	125.73	2 X 13 POWER X 2 X 24 SIGNAL	2214934-2
2.92	3.50	56.37	122.62	24	59.86	35.34	26	116.23	52	48	46	78	24	122.93	125.73	2 X 13 POWER X 2 X 24 SIGNAL	2214934-1

EE	DD	P	N	M	L	K	J	H	G	F	E	D	C	B	A	DESCRIPTION	PART NUMBER
----	----	---	---	---	---	---	---	---	---	---	---	---	---	---	---	-------------	-------------

THIS DRAWING IS A CONTROLLED DOCUMENT. DWN: L.A. HENSEL 18APR2012  
 CHG: D. DEE (RAIGH) 8APR2012  
 APVD: S. SELICKINGER 8APR2012  
 NAME: CONNECTOR ASSEMBLY, MULTI-BEAM CE, POWER/SIGNAL, VERTICAL, SOLDER MOUNT

TE CONNECTIVITY PRELIMINARY

APPROVALS: DIMENSIONS: mm; TOLERANCES UNLESS OTHERWISE SPECIFIED: 0 PLC ±0.5, 1 PLC ±0.25, 2 PLC ±0.25, 3 PLC ±0.25, 4 PLC ±0.25; FINISH: SEE NOTE 2; MATERIAL: SEE NOTE 1; WEIGHT: -; CUSTOMER DRAWING: A1 00779 ©=2214934; SCALE: 4:1; SHEET: 1 OF 2; REV: A

LOC	DIST	REVISIONS			
P	LTH	DESCRIPTION	DATE	OWN	APVD
-	-	SEE SHEET 1	-	-	-

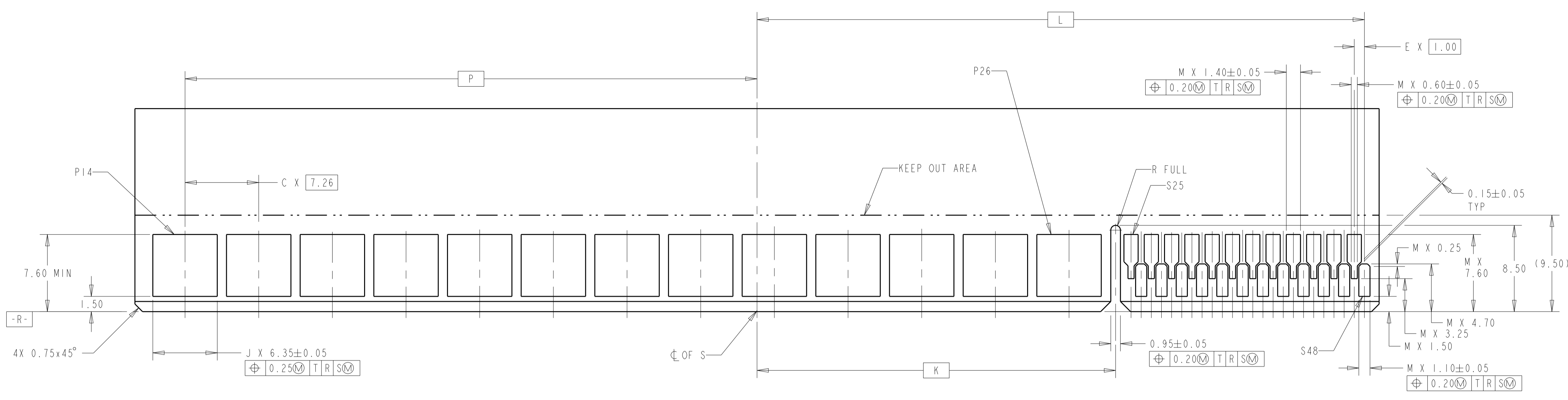

RECOMMENDED MATING BOARD EDGE CONFIGURATION  
(PRIMARY SIDE SHOWN)  
DAUGHTER CARD  
2214934-1

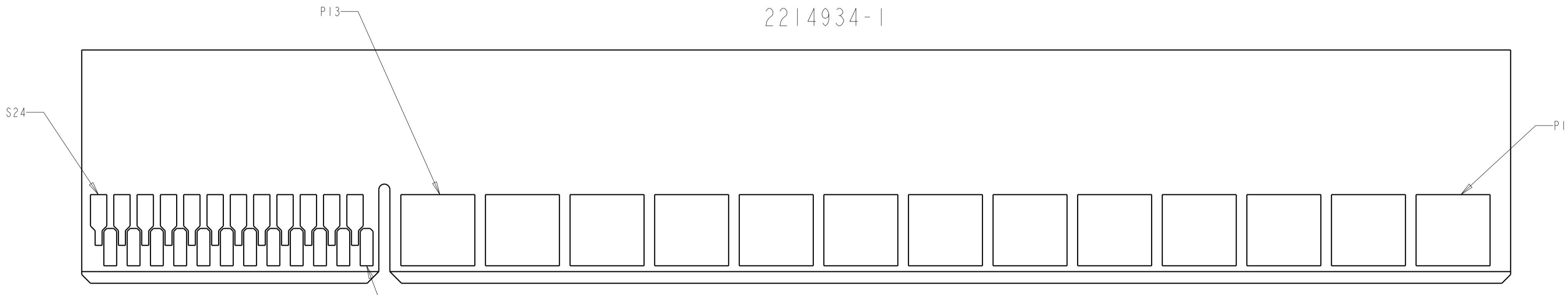

RECOMMENDED MATING BOARD EDGE CONFIGURATION  
(SECONDARY SIDE SHOWN)

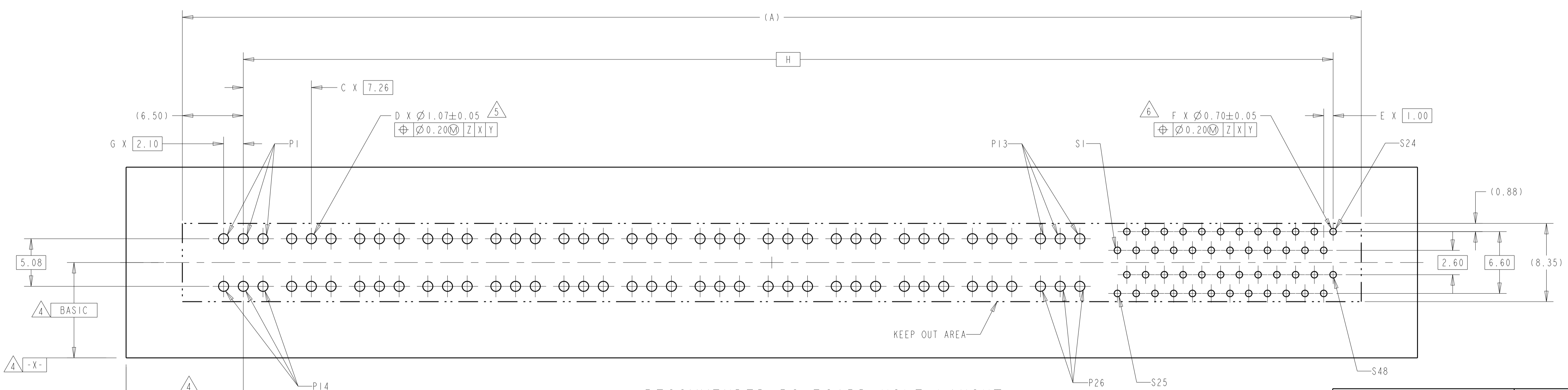

RECOMMENDED PC BOARD HOLE LAYOUT  
COMPONENT SIDE  
2214934-1 LAYOUT

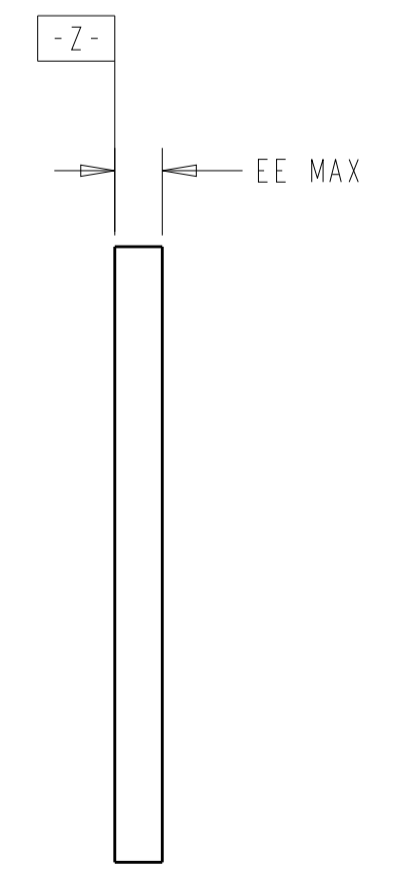

THIS DRAWING IS A CONTROLLED DOCUMENT.		OWN L.A. WENSEL 18APR2012	TE Connectivity
DIMENSIONS: mm		CHK D. DEFIBAUGH 18APR2012	
TOLERANCES UNLESS OTHERWISE SPECIFIED:		APVD S. FLICKINGER 18APR2012	NAME CONNECTOR ASSEMBLY, MULTI-BEAM CE, POWER/SIGNAL, VERTICAL, SOLDER MOUNT
		PRODUCT SPEC	APPLICATION SPEC
MATERIAL SEE NOTE 1		FINISH SEE NOTE 2	WEIGHT
CUSTOMER DRAWING		SCALE 4:1	RESTRICTED TO