

9.6 - 9.7

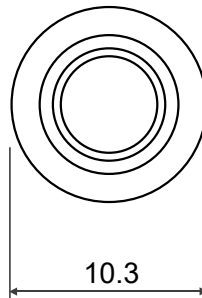
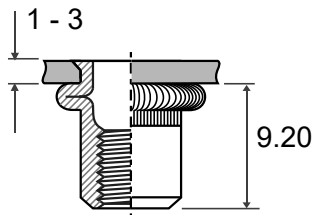

Approximate Performance in Laboratory Tests

Tensile Strength: 16500 N

Direct Torque: 11 Nm

Body Torque: 3.5 Nm

Shear Strength: 3000 N

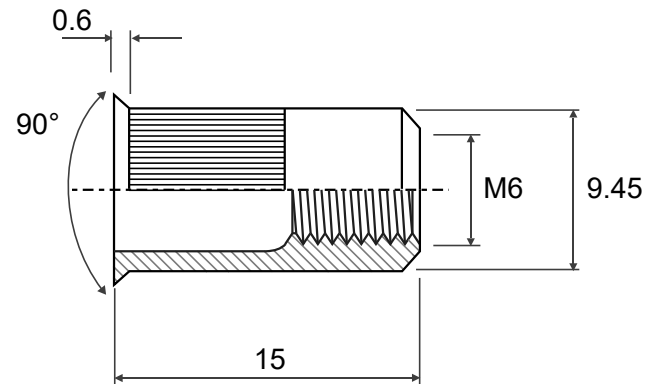

	Material		Customer Part No.	
	Finish		Web Ref No	