

Approximate Performance in Laboratory Tests

Tensile Strength: 25000 N  
Direct Torque: 20 Nm  
Body Torque: 4.5 Nm  
Shear Strength: 4400 N

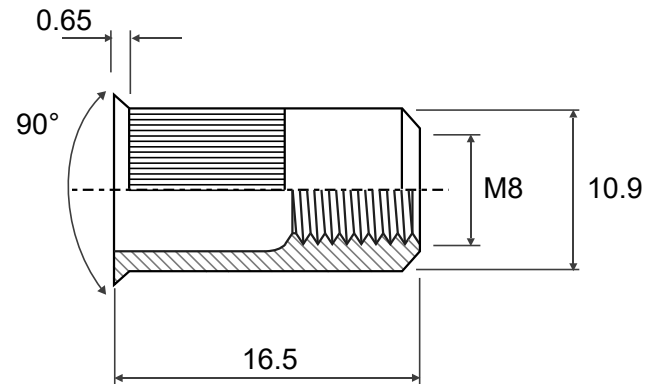

	Material		Customer Part No.	
	Finish		Web Ref No	