

DO NOT SCALE FROM THIS PRINT

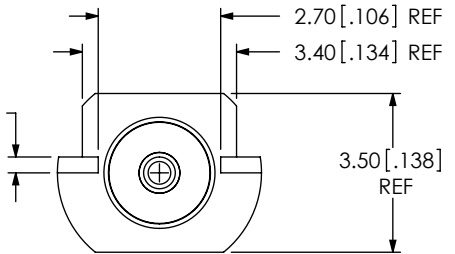

DESIGNED & DIMENSIONED IN MILLIMETERS [INCHES]

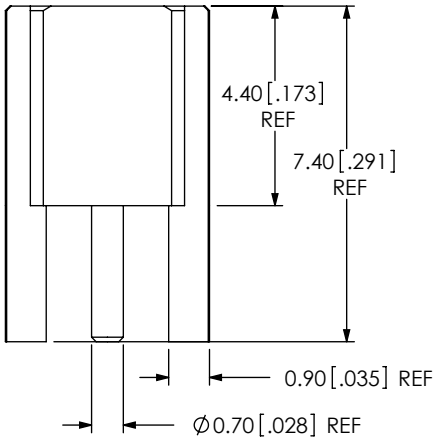
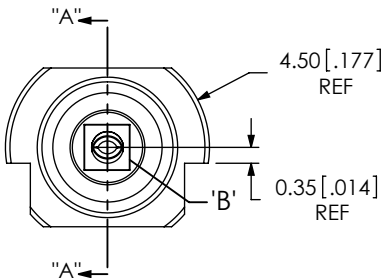
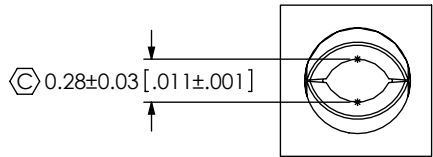

DETAIL 'B' SCALE 20:1

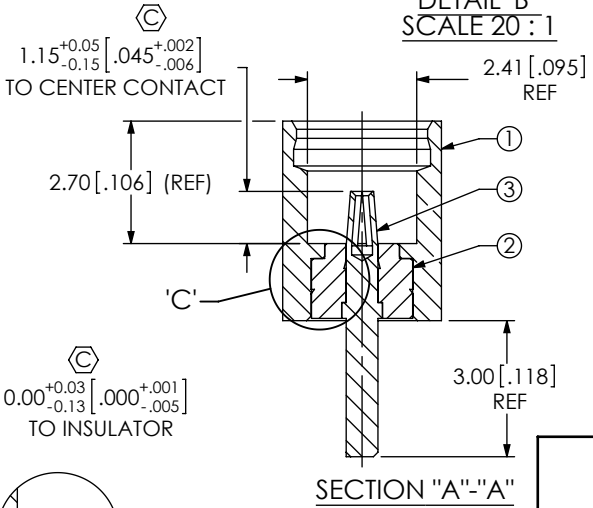

SECTION "A"- "A"

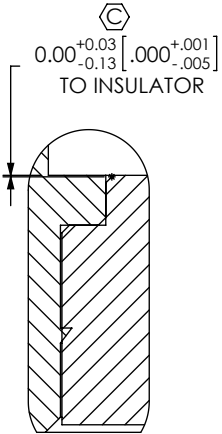

DETAIL 'C' SCALE 20:1

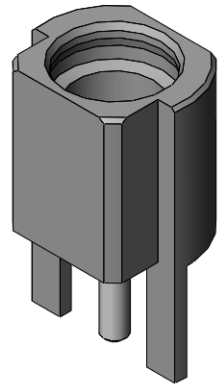

MMCX-J-P-X-ST-EM1

GENDER -J: JACK
 TYPE -P: PCB
 TERMINATION -EM1: EDGE MOUNT
 ORIENTATION -ST: STRAIGHT

PLATING SPECIFICATION
 -H: 30µ" GOLD CENTER CONTACT,
 3µ" GOLD OUTER CONTACT
 -(SEE TABLE 1)

RECOMMENDED PCB LAYOUT

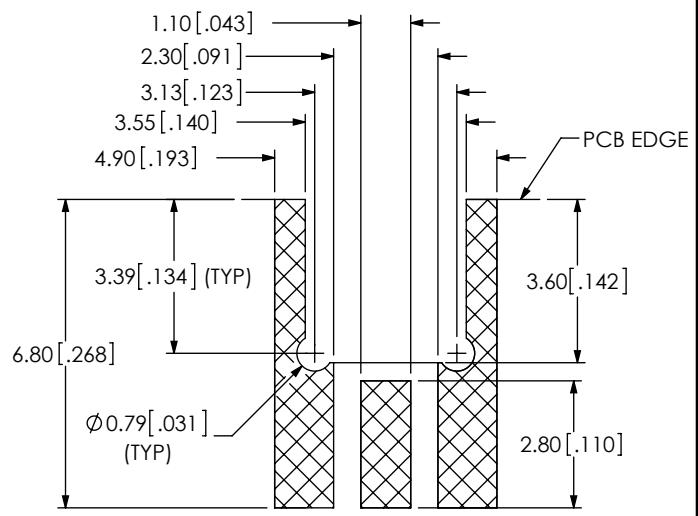

ITEM	COMPONENT	-H
1	SHELL	MMCX-J-P-F-ST-EM1-SHL
2	INSULATOR	MMCX-INS-008
3	SOCKET	MMCX-SKT-001-H

- NOTES:
- ⊗ REPRESENTS A CRITICAL DIMENSION.
 - PUSHOUT FORCE FOR INSULATOR: 22.24 N [5 LB] MIN.
 - PUSHOUT FORCE FOR CENTER CONTACT: 11.12 N [2.5 LB] MIN.
 - PRODUCT TO BE PACKAGED PER PACKING STANDARD CO-HD-WI-3040-M.
 TRAY: TY-SMA001-1
 COVER: TY-SMA001-2
 100 PARTS PER TRAY (1 PART PER POCKET)
 - NOTE DELETED.

F:\DWG\MISC\MKTG\MMCX-J-P-X-ST-EM1-MKT.SLDDRW

UNLESS OTHERWISE SPECIFIED, DIMENSIONS ARE IN MILLIMETERS [INCHES]. TOLERANCES ARE: DECIMALS ANGLES .X: ±0.3 [.01] 5° .XX: ±0.13 [.005] .XXX: ±0.051 [.0020]	PROPRIETARY NOTE THIS DOCUMENT CONTAINS INFORMATION CONFIDENTIAL AND PROPRIETARY TO SAMTEC, INC. AND SHALL NOT BE REPRODUCED OR TRANSFERRED TO OTHER DOCUMENTS OR DISCLOSED TO OTHERS OR USED FOR ANY PURPOSE OTHER THAN THAT WHICH IT WAS OBTAINED WITHOUT THE EXPRESSED WRITTEN CONSENT OF SAMTEC, INC.		
		520 PARK EAST BLVD, NEW ALBANY, IN 47150 PHONE: 812-944-6733 FAX: 812-948-5047 e-Mail: info@SAMTEC.com code: 55322	
MATERIAL: DO NOT SCALE DRAWING SHEET SCALE: 6:1		DESCRIPTION: MMCX STRAIGHT, EDGE MOUNT JACK- 50 OHM	
SHELL: BRASS C36048 INSULATOR: PTFE(WHITE) SOCKET: BeCu C17300		DWG. NO. MMCX-J-P-X-ST-EM1	
		BY:R MUSSER 11/30/2007 SHEET 1 OF 1	