

Frontplattenausschnitt
panel cut out

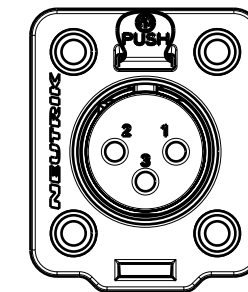

1:1

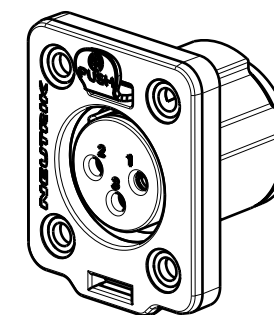
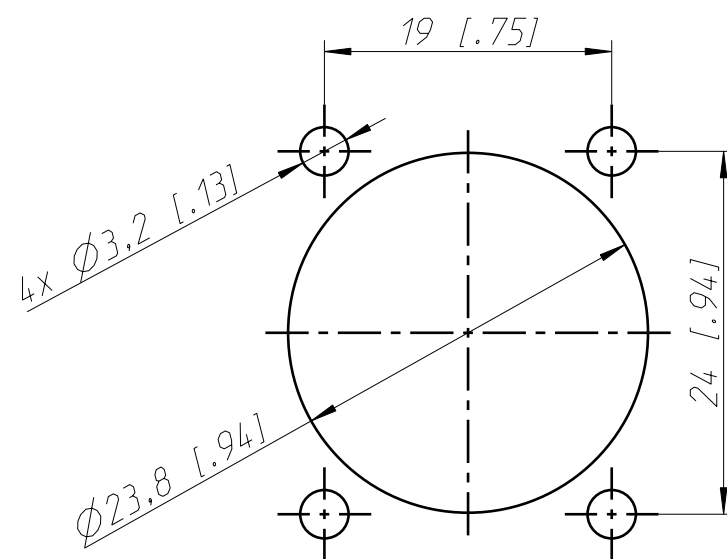
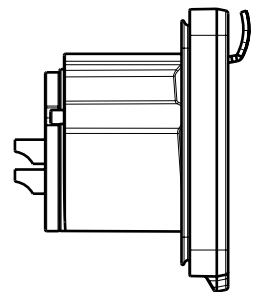

Refer to protection notice ISO 16016.	Scale 2:1 (A3)	Drawn	Date	Name
		Modified	01.03.18	jutz b
Name NC3FDX-TOP	Change-No.	Sheet-No.	Index	
		-	1 / 1	-
Replacement for:		Drawing-No.		
NEUTRIK		ST-NC3FDX-TOP		