

NOTES:

1. MATERIAL:
HOUSING LCP, UL94V-0 AND GLOW WIRE CAPABLE PER IEC 60335-1, BLACK. TERMINAL COPPER
2. FINISH (PLATING):
(TIN) 1.52 MICROMETER MIN (60 MICROINCH MIN) REFLOWED MATTE TIN OVER
1.27 MICROMETER MIN (50 MICROINCH MIN) MIN NICKEL OVERALL.
(15 GOLD) 0.38 MICROMETER MIN (15 MICROINCH MIN) SELECTIVE GOLD ON CONTACT AREA
WITH 2.54 MICROMETER MIN (100 MICROINCHES MIN) SELECTIVE TIN ON SOLDER AREA
BOTH OVER 1.27 MICROMETER MIN (50 MICROINCHES MIN) NICKEL OVERALL.
(30 GOLD) 0.76 MICROMETER MIN (30 MICROINCH MIN) SELECTIVE GOLD ON CONTACT AREA
WITH 2.54 MICROMETER MIN (100 MICROINCHES MIN) SELECTIVE TIN ON SOLDER AREA
BOTH OVER 1.27 MICROMETER MIN (50 MICROINCHES MIN) NICKEL OVERALL.
3. PRODUCT SPECIFICATION 1720631000-PS.
4. PART MATES WITH MOLEX PART NUMBER 200456 SERIES.
5. PARTS CONFORM TO CLASS "B" REQUIREMENTS OF COSMETIC SPECIFICATION PS-45499-002.
6. PARTS TO BE PACKAGED PER 2002411000.
7. APPLICATION SPECIFICATION: AS-76823-200

SYMBOLS		THIS DRAWING CONTAINS INFORMATION THAT IS PROPRIETARY TO MOLEX ELECTRONIC TECHNOLOGIES, LLC AND SHOULD NOT BE USED WITHOUT WRITTEN PERMISSION	
DIMENSION UNITS	SCALE	CURRENT REV DESC:	
$\nabla = 0$	mm	2:1	molex MEGA-FIT HDR ASMY TOP LATCH,VERT,2-8CKT
$\nabla = 6$	GENERAL TOLERANCES (UNLESS SPECIFIED)		
$\nabla = 0$	ANGULAR TOL $\pm 0.5^\circ$		EC NO: 624315 DRWN: ALUO02 2019/10/14 CHK'D: AYIN 2019/10/29 APPR: AYIN 2019/10/29
$\nabla = 0$	4 PLACES	\pm	
$\nabla = 0$	3 PLACES	\pm	INITIAL REVISION: DRWN: YXZHENG 2018/07/18 APPR: YXZHENG 2018/08/06
$\nabla = 0$	2 PLACES	± 0.25	
$\nabla = 0$	1 PLACE	± 0.35	DOCUMENT NUMBER 2002411000 DOC TYPE PSD DOC PART 000 REVISION C
$\nabla = 0$	0 PLACES	\pm	
$\square = 0$	DRAFT WHERE APPLICABLE MUST REMAIN WITHIN DIMENSIONS		MATERIAL NUMBER SEE CHART CUSTOMER GENERAL MARKET SHEET NUMBER 1 OF 3
$\nabla = 0$	THIRD ANGLE PROJECTION		
DRAWING		SERIES	
A3-SIZE		200241	

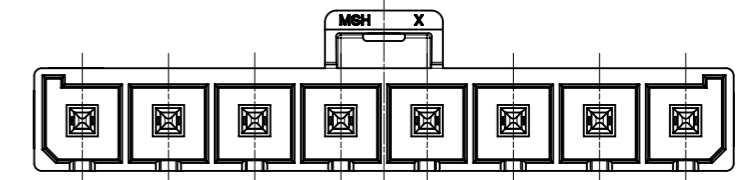
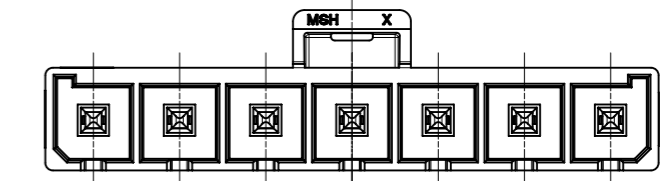
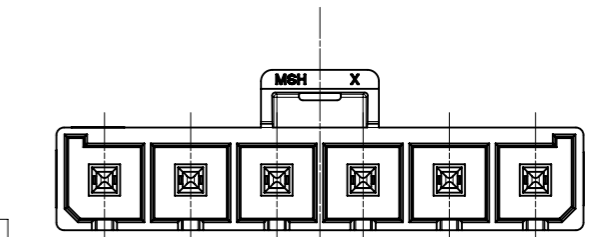
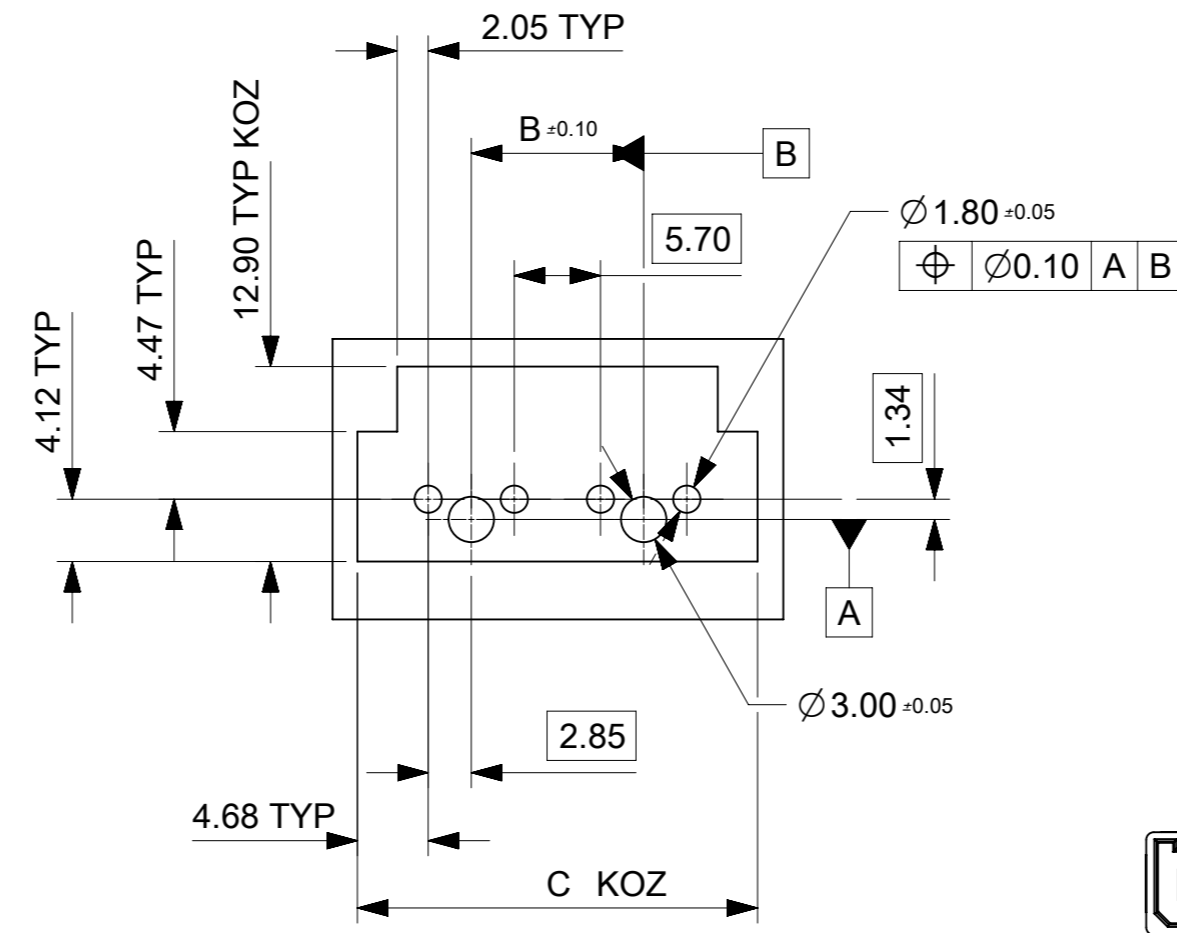
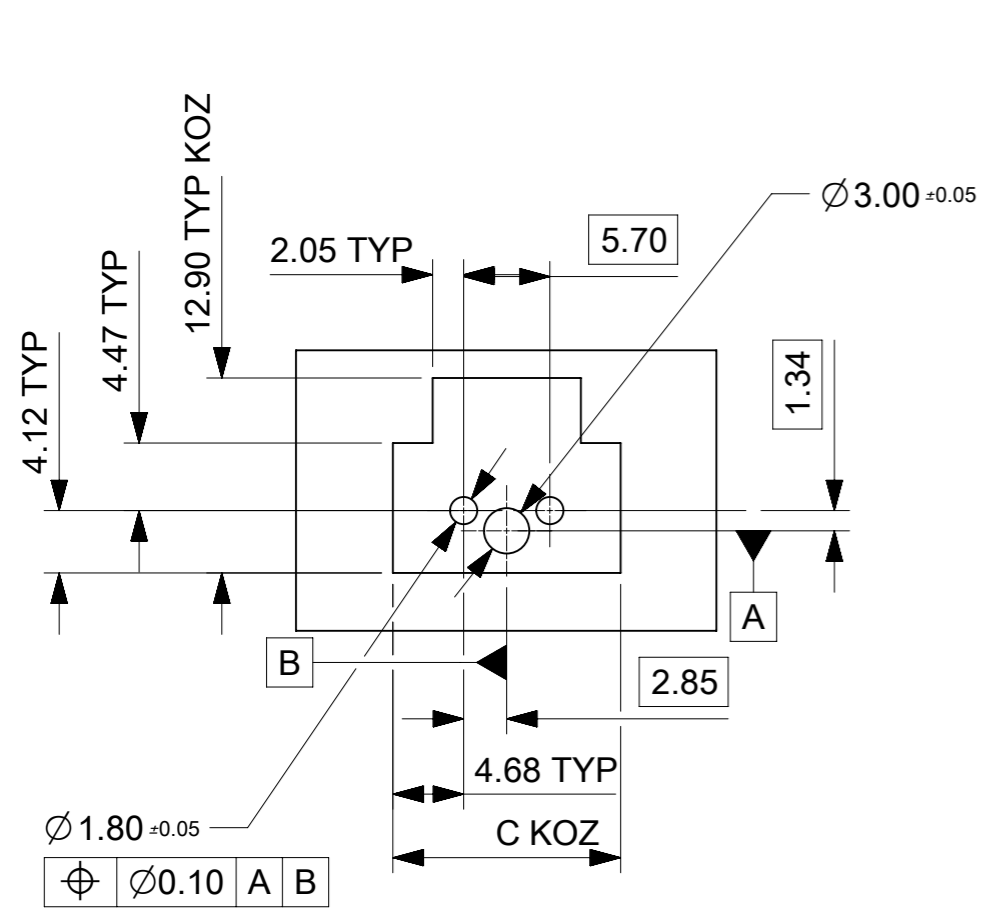
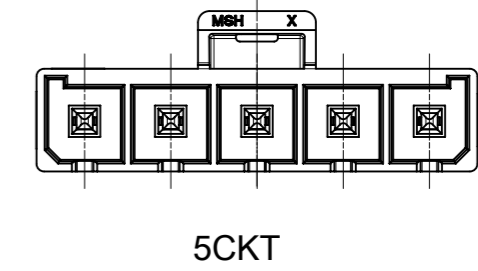
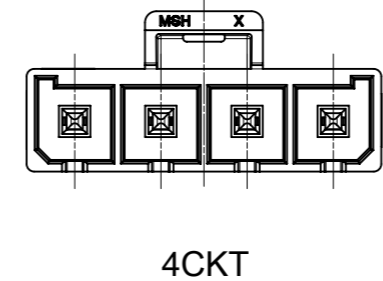
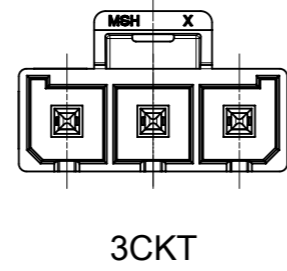
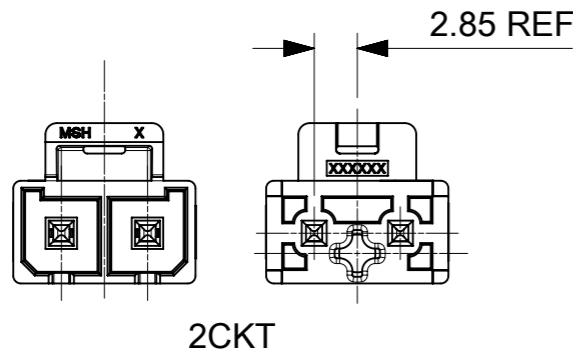

PCB LAYOUT: COMPONENT SIDE
RECOMMENDED PCB THICKNESS: 1.58 MM/.062 IN
TO2.36 MM/.093 IN

SYMBOLS	THIS DRAWING CONTAINS INFORMATION THAT IS PROPRIETARY TO MOLEX ELECTRONIC TECHNOLOGIES, LLC AND SHOULD NOT BE USED WITHOUT WRITTEN PERMISSION		CURRENT REV DESC:			molex		
	▽ = 0	mm						
▽ = 0	GENERAL TOLERANCES (UNLESS SPECIFIED)		EC NO: 624315			MEGA-FIT HDR ASMY TOP LATCH, VERT, 2-8CKT		
▽ = 0	ANGULAR TOL ± 0.5°		DRWN: ALUO02 2019/10/14			PRODUCT CUSTOMER DRAWING		
▽ = 0	4 PLACES ±		CHK'D: AYIN 2019/10/29			DOCUMENT NUMBER		
▽ = 0	3 PLACES ±		APPR: AYIN 2019/10/29			2002411000		
▽ = 0	2 PLACES ± 0.25		INITIAL REVISION:			DOC TYPE		
▽ = 0	1 PLACE ± 0.35		DRWN: YXZHENG 2018/07/18			PSD		
▽ = 0	0 PLACES ±		APPR: YXZHENG 2018/08/06			DOC PART		
▽ = 0	DRAFT WHERE APPLICABLE MUST REMAIN WITHIN DIMENSIONS		THIRD ANGLE PROJECTION			REVISION		
▽ = 0			DRAWING			C		
			SERIES			SHEET NUMBER		
			A3-SIZE			2 OF 3		
			MATERIAL NUMBER			CUSTOMER		
			200241			GENERAL MARKET		
			SEE CHART					

9		8			7			6			5			4			3			2			1		
CKT	PLATING CODE	CORLOR	PART NUMBER	DIM-A	DIM-B	DIM-C	PK SPEC	CKT	PLATING CODE	CORLOR	PART NUMBER	DIM-A	DIM-B	DIM-C	PK SPEC	CKT	PLATING CODE	CORLOR	PART NUMBER	DIM-A	DIM-B	DIM-C	PK SPEC		
2	TIN	BLACK	2002411112	12.05	N/A	15.06	TRAY	*	2	TIN	BLACK	2002411712	12.05	N/A	15.06	TAPE&REEL WITHOUT KAPTON	*	2	TIN	BLACK	2002411612	12.05	N/A	15.06	
3			2002411113	17.75	5.7	20.76		*	3			2002411713	17.75	5.7	20.76		*	3			2002411613	17.75	5.7	20.76	
4			2002411114	23.45	11.4	26.46		*	4			2002411714	23.45	11.4	26.46		*	4			2002411614	23.45	11.4	26.46	
5			2002411115	29.15	17.1	32.16		*	5			2002411715	29.15	17.1	32.16		*	5			2002411615	29.15	17.1	32.16	
6			2002411116	34.85	22.8	37.86		*	6			2002411716	34.85	22.8	37.86		*	6			2002411616	34.85	22.8	37.86	
7			2002411117	40.55	28.5	43.56		*	7			2002411717	40.55	28.5	43.56		*	7			2002411617	40.55	28.5	43.56	
8			2002411118	46.25	34.2	49.26		*	8			2002411718	46.25	34.2	49.26		*	8			2002411618	46.25	34.2	49.26	
2			15"GOLD	BLACK	2002411122	12.05		N/A	15.06			TRAY	*	2	15"GOLD		BLACK	2002411722			12.05	N/A	15.06	TAPE&REEL WITHOUT KAPTON	*
3	2002411123	17.75			5.7	20.76	*	3	2002411723	17.75	5.7		20.76	*		3		2002411623	17.75	5.7	20.76				
4	2002411124	23.45			11.4	26.46	*	4	2002411724	23.45	11.4		26.46	*		4		2002411624	23.45	11.4	26.46				
5	2002411125	29.15			17.1	32.16	*	5	2002411725	29.15	17.1		32.16	*		5		2002411625	29.15	17.1	32.16				
6	2002411126	34.85			22.8	37.86	*	6	2002411726	34.85	22.8		37.86	*		6		2002411626	34.85	22.8	37.86				
7	2002411127	40.55			28.5	43.56	*	7	2002411727	40.55	28.5		43.56	*		7		2002411627	40.55	28.5	43.56				
8	2002411128	46.25			34.2	49.26	*	8	2002411728	46.25	34.2		49.26	*		8		2002411628	46.25	34.2	49.26				
2	30"GOLD	BLACK			2002411132	12.05	N/A	15.06	TRAY	*	2		30"GOLD	BLACK		2002411732		12.05	N/A	15.06	TAPE&REEL WITHOUT KAPTON	*	2		30"GOLD
3			2002411133	17.75	5.7	20.76	*	3		2002411733	17.75	5.7			20.76	*	3	2002411633	17.75	5.7		20.76			
4			2002411134	23.45	11.4	26.46	*	4		2002411734	23.45	11.4			26.46	*	4	2002411634	23.45	11.4		26.46			
5			2002411135	29.15	17.1	32.16	*	5		2002411735	29.15	17.1			32.16	*	5	2002411635	29.15	17.1		32.16			
6			2002411136	34.85	22.8	37.86	*	6		2002411736	34.85	22.8			37.86	*	6	2002411636	34.85	22.8		37.86			
7			2002411137	40.55	28.5	43.56	*	7		2002411737	40.55	28.5			43.56	*	7	2002411637	40.55	28.5		43.56			
8			2002411138	46.25	34.2	49.26	*	8		2002411738	46.25	34.2			49.26	*	8	2002411638	46.25	34.2		49.26			

* DESIGNATES PART NOT RELEASED
CONTACT FACTORY FOR AVAILABILITY.

SYMBOLS	THIS DRAWING CONTAINS INFORMATION THAT IS PROPRIETARY TO MOLEX ELECTRONIC TECHNOLOGIES, LLC AND SHOULD NOT BE USED WITHOUT WRITTEN PERMISSION		CURRENT REV DESC:		molex		
	DIMENSION UNITS	SCALE					
	mm	1:1	PRODUCT CUSTOMER DRAWING				
	GENERAL TOLERANCES (UNLESS SPECIFIED)					DOCUMENT NUMBER	
ANGULAR TOL	± 0.5°	EC NO: 624315			2019/10/14		
4 PLACES	±	DRWN: ALUO02			2019/10/29		
3 PLACES	±	CHK'D: AYIN			2019/10/29		
2 PLACES	± 0.25	APPR: AYIN			2019/10/29		
1 PLACE	± 0.35	INITIAL REVISION:			2018/07/18		
0 PLACES	±	DRWN: YXZHENG			2018/08/06		
DRAFT WHERE APPLICABLE MUST REMAIN WITHIN DIMENSIONS		THIRD ANGLE PROJECTION	DRAWING	SERIES	MATERIAL NUMBER	CUSTOMER	SHEET NUMBER
			A3-SIZE	200241	2002411000	GENERAL MARKET	3 OF 3