

In case of consideration for using Automotive equipment / device which demand high reliability, kindly contact our sales window.

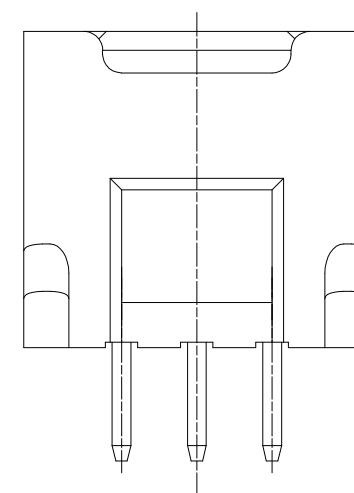

RECOMMENDED LAND PATTERN (FREE)
(PCB THICKNESS t=1.6mm)

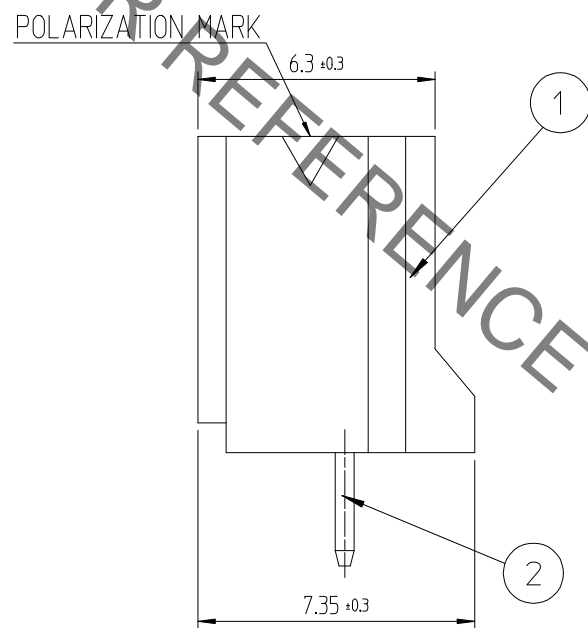
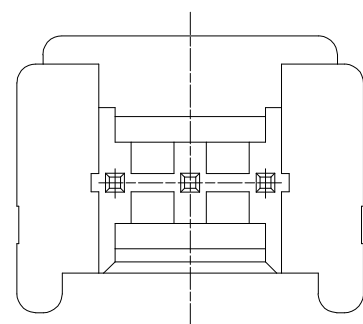
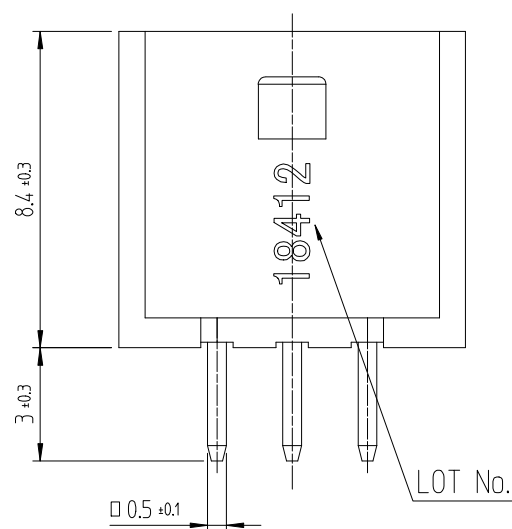
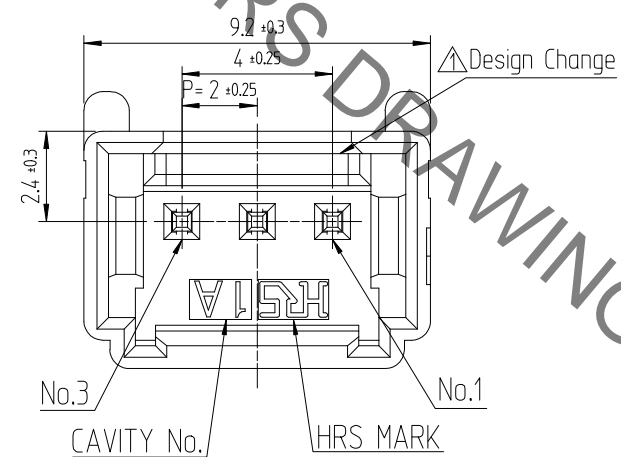
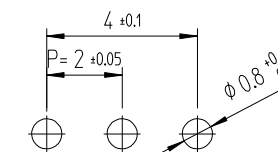

ENGAGEMENT FIGURE (2:1)

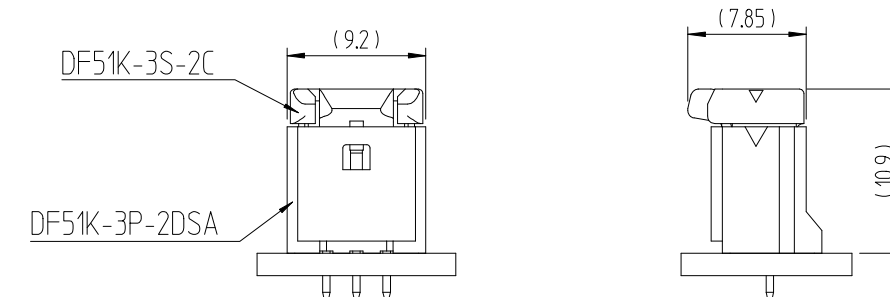

NOTE 1. 1PACK CONTAINS 100PCS.
2. () DIMENSIONS ARE ONLY REFERENCE.

△數 COUNT	訂正事項 DESCRIPTION OF REVISIONS	擔當 B Y	檢圖 CHKD	年月日 DATE	△數 COUNT	訂正事項 DESCRIPTION OF REVISIONS	擔當 B Y	檢圖 CHKD	年月日 DATE
1	RE-6-1150	K.I.Y	L.S.M	18. 07. 04					

1	PBT	UL94V-0, BLACK	2	BRASS	TIN PLATING 1μm MIN, OVER NICKEL 0.5μm MIN
NO.	MATERIAL	FINISH,REMARKS	NO.	MATERIAL	FINISH,REMARKS
CODE NO. (OLD)			DRAWN	DESIGNED	CHECKED
			CHOI 17.12.22 J.S	CHOI 17.12.22 J.S	LIM 17.12.22 S.M
			APPROVED		
			KANG 17.12.22 T.S		
			RELEASED		
DRAWING NO. EDC3-632303			PART NO. DF51K-3P-2DSA (800)		
SCALE 5:1			CODE NO. CL 6652-0002-4-800		
UNITS mm			HRS HIROSE KOREA CO.,LTD.		
					1/1