

RoHS COMPLIANT

<b>ENTER DESCRIPTION</b> IEC NO: 2012-0253 MDR: VAVITTARAR 2012/02/14 CHKD: APPR: KPRASAD REV: 2012/02/15	<b>QUALITY SYMBOLS</b> ▽=0 ▽=0	<b>GENERAL TOLERANCES (UNLESS SPECIFIED)</b>	<b>DIMENSION STYLE</b> MM ONLY	<b>SCALE</b> 1:1	<b>DESIGN UNITS</b> METRIC	THIRD ANGLE PROJECTION	
	4 PLACES ± --- ± --- 3 PLACES ± --- ± --- 2 PLACES ± 0.1 ± --- 1 PLACE ± 0.2 ± --- ANGULAR ± 1°	DRAWN BY: DKUMAR CHECKED BY: KPRASAD APPROVED BY: GJLOWE DATE: 20/12/2005	DATE: 20/12/2005	TITLE: CMC HEADER T3 INTERFACE - BK & BR 96/72 AND 96/96	MATERIAL NO.	DOCUMENT NO.	SHEET NO.
	DRAFT WHERE APPLICABLE MUST REMAIN WITHIN DIMENSIONS	SEE TABLE	SD-36638-001	1 OF 3	THIS DRAWING CONTAINS INFORMATION THAT IS PROPRIETARY TO MOLEX INCORPORATED AND SHOULD NOT BE USED WITHOUT WRITTEN PERMISSION		
	MOLEX INCORPORATED						

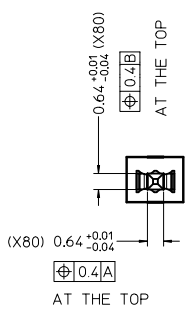

DETAIL 1  
SCALE 10:1

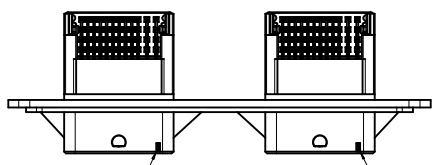
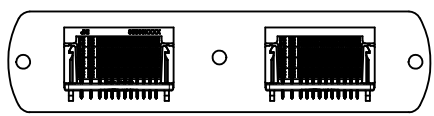
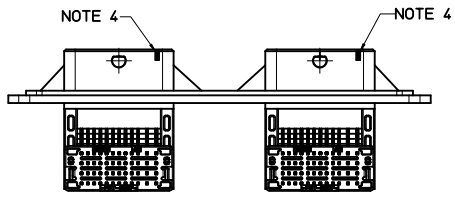
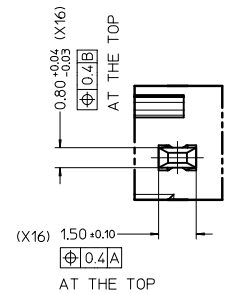

DETAIL 2  
SCALE 10:1

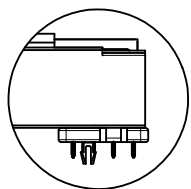

96/96 OR 96/72 CMC HEADER  
WITH PCB SNAP LOCKING

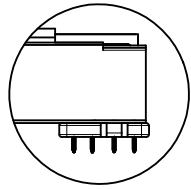

96/96 OR 96/72 CMC HEADER  
WITHOUT PCB SNAP LOCKING

36638-0012	CMC HEADER, T3-BR & BN, WITH PCB SNAP LOCK, 96/96	BROWN	BLACK	L1 & M1 L2 & M2 L3 & M3 L4 & M4	A1 TO H1, J1 & K1 A2 TO H2, J2 & K2 A3 TO H3, J3 & K3 A4 TO H4, J4 & K4	D
36638-0011	CMC HEADER, T3-BR & BN, W/O PCB SNAP LOCK, 96/96			C		
36638-0010	CMC HEADER, T3-BR & BN, WITH PCB SNAP LOCK, 96/72	BROWN	BLACK	L2 & M2 L3 & M3 L4 & M4	A2 TO H2, J2 & K2 A3 TO H3, J3 & K3 A4 TO H4, J4 & K4	B
36638-0001	CMC HEADER, T3-BR & BN, W/O PCB SNAP LOCK, 96/72			A		
MOLEX PART NO.	PART DISCRPTION	LEFT MODULE	RIGHT MODULE	1.5 PIN	0.64 PIN	PCB LAYOUT TO BE REFERRED
		COLOUR CODE	CAVITIES TO BE USED			

5	GRID PLATE WITH PCB LOCK	PBT 30% GLASS FILLED	BLACK	0	2	0	2	0
4	GRID PLATE W/O PCB LOCK		BLACK	2	0	2	0	2
3	HOUSING		BLACK	1	1	1	1	1
2	PIN 1.50	CuZn30	NICKEL UNDERCOAT: 1.3µM TO 2.2µM	12	12	16	16	12
1	PIN 0.64	CuZn30	MATTE TIN OVERCOAT: 4µM TO 5µM	60	60	80	80	60
SL.NO	DESIGNATION	MATERIAL	FINISH	BOM QUANTITY				
				36638-0001	36638-0010	36638-0011	36638-0012	36638-0010E

- NOTE:
1. PAINT BROWN PAINT(RoHS COMPLIANT) AT THE SPECIFIED AREA OF LEFT MODULE ON BOTH SIDES
  2. AREA FOR JXI AND MOLEX PART NUMBER REPRESENTATION.
  3. AREA FOR PLASTIC MATERIAL >PBT-30%GF< DESCRIPTION.
  4. PAINT WITH WHITE COLOR (RoHS COMPLIANT) AT SPECIFIED FOUR AREAS
  5. PART TO MEET SOLDERABILITY SPEC SMES-152
  6. PACKAGING SPECIFICATION: PK-36638-001
  7. FOR PART # 36638-0001 REFER PACKAGING SPEC:PK-36638-004

RoHS COMPLIANT

<b>ENTER DESCRIPTION</b> IEC NO: 2012-0253 DRAWN: VITARRAR 2012/02/14 CHKD: APPR: KPRASAD 2012/02/15	QUALITY SYMBOLS	GENERAL TOLERANCES (UNLESS SPECIFIED)	DIMENSION STYLE	SCALE	DESIGN UNITS	THIRD ANGLE PROJECTION
	$\nabla=0$ $\nabla=0$	mm    INCH 4 PLACES ± --- ± --- 3 PLACES ± --- ± --- 2 PLACES ± 0.1 ± --- 1 PLACE ± 0.2 ± --- ANGULAR ± 1°	<b>MM ONLY</b> DRAWN BY DATE DKUMAR 20/12/2005 CHECKED BY DATE KPRASAD 20/12/2005 APPROVED BY DATE GJLOWE 20/12/2005	1:1	METRIC	
	DRAFT WHERE APPLICABLE MUST REMAIN WITHIN DIMENSIONS	MATERIAL NO. <b>SEE TABLE</b>	TITLE <b>CMC HEADER T3 INTERFACE - BK &amp; BR 96/72 AND 96/96</b>	MOLEX INCORPORATED	DOCUMENT NO. <b>SD-36638-001</b>	SHEET NO. <b>2 OF 3</b>
	THIS DRAWING CONTAINS INFORMATION THAT IS PROPRIETARY TO MOLEX INCORPORATED AND SHOULD NOT BE USED WITHOUT WRITTEN PERMISSION					

**PCB LAYOUT: A**

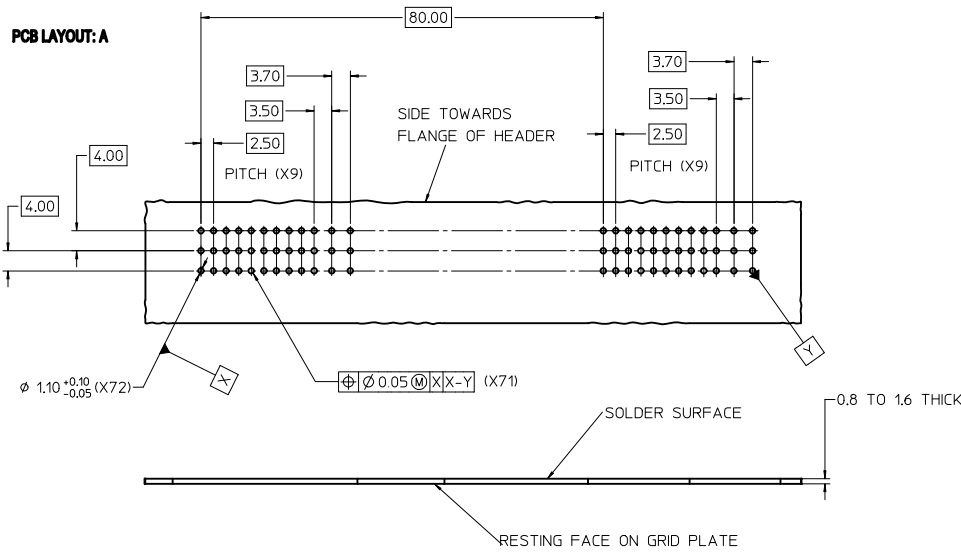

**PCB LAYOUT: B**

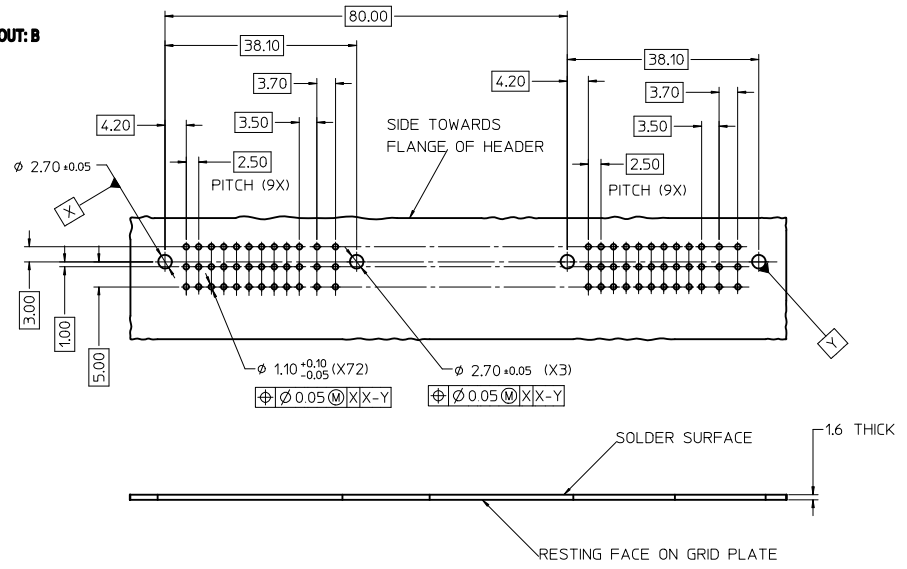

**PCB LAYOUT: C**

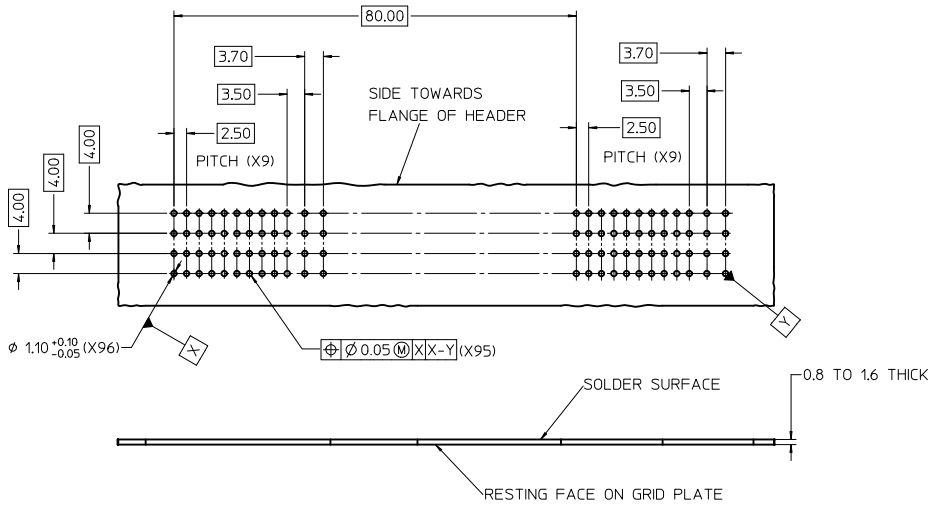

**PCB LAYOUT: D**

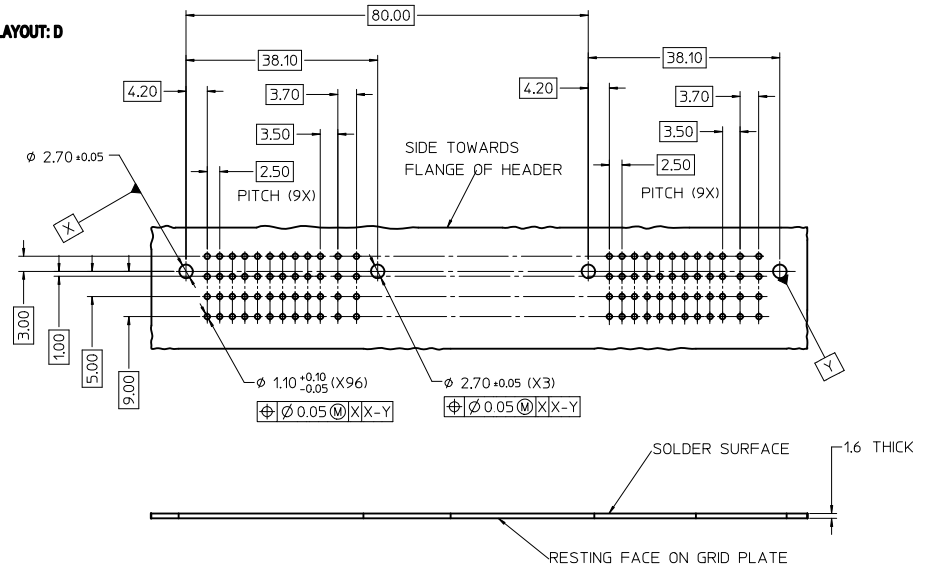

RoHS COMPLIANT

<b>ENTER DESCRIPTION</b> EC NO: 2012-0253 DRAWN BY: DR.MANVIKAR CHKD: APPR:KPRASAD 2012/02/15	QUALITY SYMBOLS ▽=0 ▽=0	GENERAL TOLERANCES (UNLESS SPECIFIED) mm INCH 4 PLACES ± --- ± --- 3 PLACES ± --- ± --- 2 PLACES ± 0.1 ± --- 1 PLACE ± 0.2 ± --- ANGULAR ± 1 °	DIMENSION STYLE MM ONLY	SCALE 2:1	DESIGN UNITS METRIC	THIRD ANGLE PROJECTION	
	DRAWN BY: DKUMAR DATE: 20/12/2005	CHECKED BY: KPRASAD DATE: 20/12/2005	APPROVED BY: GJLOWE DATE: 20/12/2005	MATERIAL NO. SEE TABLE	DOCUMENT NO. SD-36638-001	TITLE CMC HEADER T3 INTERFACE - BK & BR 96/72 AND 96/96	SHEET NO. 3 OF 3
	MOLEX INCORPORATED						
	THIS DRAWING CONTAINS INFORMATION THAT IS PROPRIETARY TO MOLEX INCORPORATED AND SHOULD NOT BE USED WITHOUT WRITTEN PERMISSION						

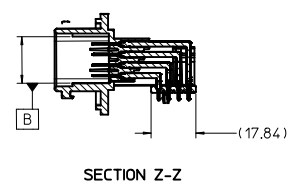
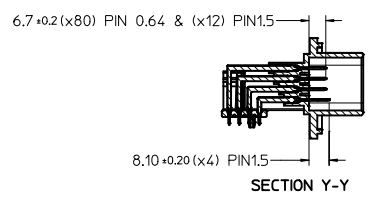
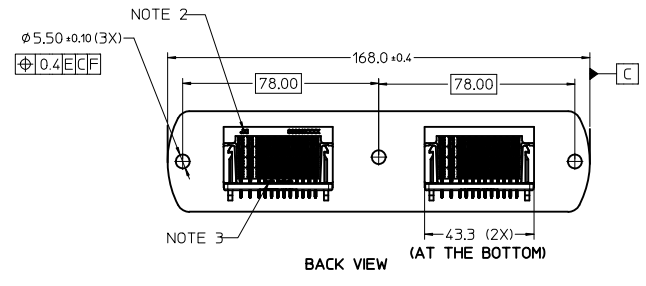
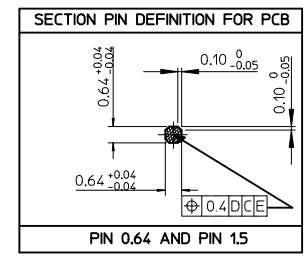
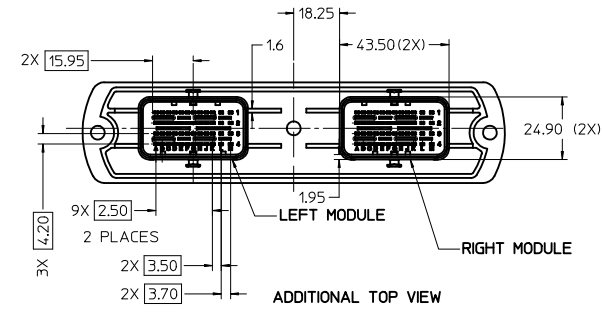
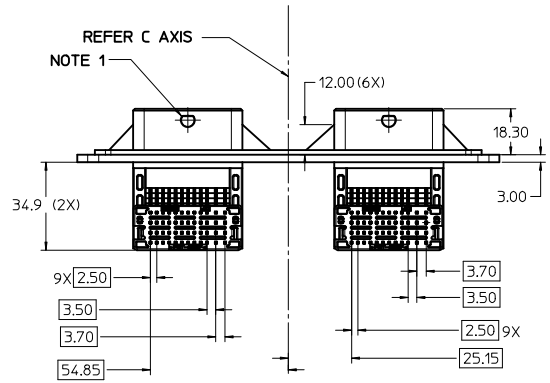
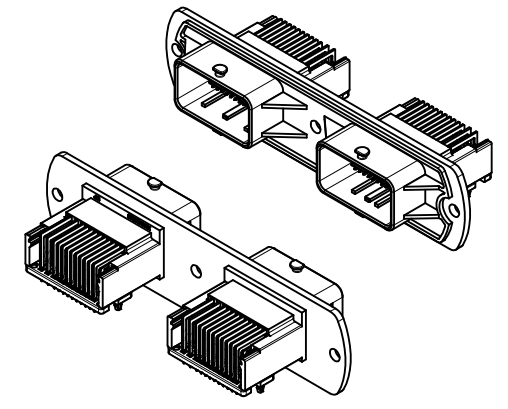
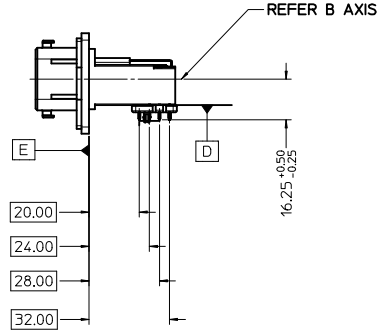
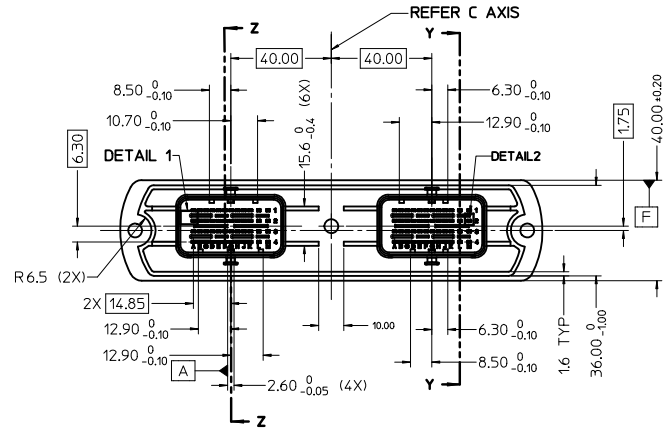

RoHS COMPLIANT

<b>ENTER DESCRIPTION</b> IEC NO: 2012-0253 DRAWN: VITTHAR 2012/02/14 CHKD: APPR: KPRASAD REV: 2012/02/15	<b>QUALITY SYMBOLS</b> ▽=0 ▽=0	<b>GENERAL TOLERANCES (UNLESS SPECIFIED)</b>	<b>DIMENSION STYLE</b> MM ONLY	<b>SCALE</b> 1:1	<b>DESIGN UNITS</b> METRIC	<b>THIRD ANGLE PROJECTION</b>	
	4 PLACES ± --- ± --- 3 PLACES ± --- ± --- 2 PLACES ± 0.1 ± --- 1 PLACE ± 0.2 ± --- ANGULAR ± 1°	mm INCH	DRAWN BY: DKUMAR CHECKED BY: KPRASAD APPROVED BY: GJLOWE DATE: 20/12/2005	DATE: 20/12/2005	TITLE: CMC HEADER T3 INTERFACE - BK & BR 96/72 AND 96/96	MATERIAL NO.	DOCUMENT NO. SD-36638-001
	DRAFT WHERE APPLICABLE MUST REMAIN WITHIN DIMENSIONS	SEE TABLE	THIS DRAWING CONTAINS INFORMATION THAT IS PROPRIETARY TO MOLEX INCORPORATED AND SHOULD NOT BE USED WITHOUT WRITTEN PERMISSION	SHEET NO. 1 OF 3			

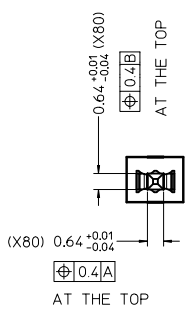
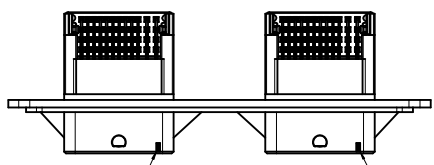
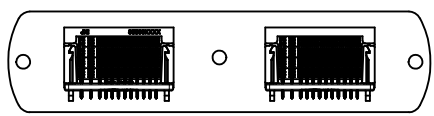
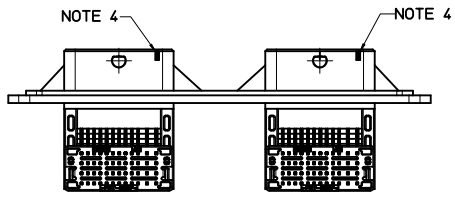

DETAIL 1  
SCALE 10:1

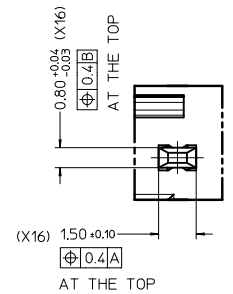

DETAIL 2  
SCALE 10:1

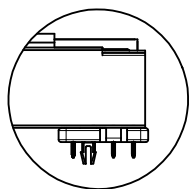

96/96 OR 96/72 CMC HEADER  
WITH PCB SNAP LOCKING

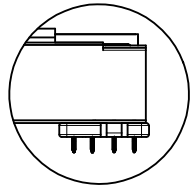

96/96 OR 96/72 CMC HEADER  
WITHOUT PCB SNAP LOCKING

36638-0012	CMC HEADER, T3-BR & BN, WITH PCB SNAP LOCK, 96/96	BROWN	BLACK	L1 & M1 L2 & M2 L3 & M3 L4 & M4	A1 TO H1, J1 & K1 A2 TO H2, J2 & K2 A3 TO H3, J3 & K3 A4 TO H4, J4 & K4	D
36638-0011	CMC HEADER, T3-BR & BN, W/O PCB SNAP LOCK, 96/96			C		
36638-0010	CMC HEADER, T3-BR & BN, WITH PCB SNAP LOCK, 96/72	BROWN	BLACK	L2 & M2 L3 & M3 L4 & M4	A2 TO H2, J2 & K2 A3 TO H3, J3 & K3 A4 TO H4, J4 & K4	B
36638-0001	CMC HEADER, T3-BR & BN, W/O PCB SNAP LOCK, 96/72			A		
MOLEX PART NO.	PART DISCRPTION	LEFT MODULE	RIGHT MODULE	1.5 PIN	0.64 PIN	PCB LAYOUT TO BE REFERRED
		COLOUR CODE		CAVITIES TO BE USED		

5	GRID PLATE WITH PCB LOCK	PBT 30% GLASS FILLED	BLACK	0	2	0	2	0
4	GRID PLATE W/O PCB LOCK		BLACK	2	0	2	0	2
3	HOUSING		BLACK	1	1	1	1	1
2	PIN 1.50	CuZn30	NICKEL UNDERCOAT: 1.3µM TO 2.2µM	12	12	16	16	12
1	PIN 0.64	CuZn30	MATTE TIN OVERCOAT: 4µM TO 5µM	60	60	80	80	60
SL.NO	DESIGNATION	MATERIAL	FINISH	BOM QUANTITY				
				36638-0001	36638-0010	36638-0011	36638-0012	36638-0010E

- NOTE:
1. PAINT BROWN PAINT(RoHS COMPLIANT) AT THE SPECIFIED AREA OF LEFT MODULE ON BOTH SIDES
  2. AREA FOR JXI AND MOLEX PART NUMBER REPRESENTATION.
  3. AREA FOR PLASTIC MATERIAL >PBT-30%GF< DESCRIPTION.
  4. PAINT WITH WHITE COLOR (RoHS COMPLIANT) AT SPECIFIED FOUR AREAS
  5. PART TO MEET SOLDERABILITY SPEC SMES-152
  6. PACKAGING SPECIFICATION: PK-36638-001
  7. FOR PART # 36638-0001 REFER PACKAGING SPEC:PK-36638-004

RoHS COMPLIANT

<b>ENTER DESCRIPTION</b> IEC NO: 2012-0253 DRAWN:VITARRAR 2012/02/14 CHKD: APPR:KPRASAD REV:	QUALITY SYMBOLS	GENERAL TOLERANCES (UNLESS SPECIFIED)	DIMENSION STYLE	SCALE	DESIGN UNITS	THIRD ANGLE PROJECTION
	$\nabla=0$ $\nabla=0$	mm    INCH 4 PLACES ± --- ± --- 3 PLACES ± --- ± --- 2 PLACES ± 0.1 ± --- 1 PLACE ± 0.2 ± --- ANGULAR ± 1°	<b>MM ONLY</b> DRAWN BY DATE DKUMAR 20/12/2005 CHECKED BY DATE KPRASAD 20/12/2005 APPROVED BY DATE GJLOWE 20/12/2005	1:1	METRIC	
	DRAFT WHERE APPLICABLE MUST REMAIN WITHIN DIMENSIONS	MATERIAL NO. <b>SEE TABLE</b>	TITLE <b>CMC HEADER T3 INTERFACE - BK &amp; BR 96/72 AND 96/96</b> <b>MOLEX INCORPORATED</b>	DOCUMENT NO. <b>SD-36638-001</b>	SHEET NO. <b>2 OF 3</b>	
	SIZE 	THIS DRAWING CONTAINS INFORMATION THAT IS PROPRIETARY TO MOLEX INCORPORATED AND SHOULD NOT BE USED WITHOUT WRITTEN PERMISSION				

**PCB LAYOUT: A**

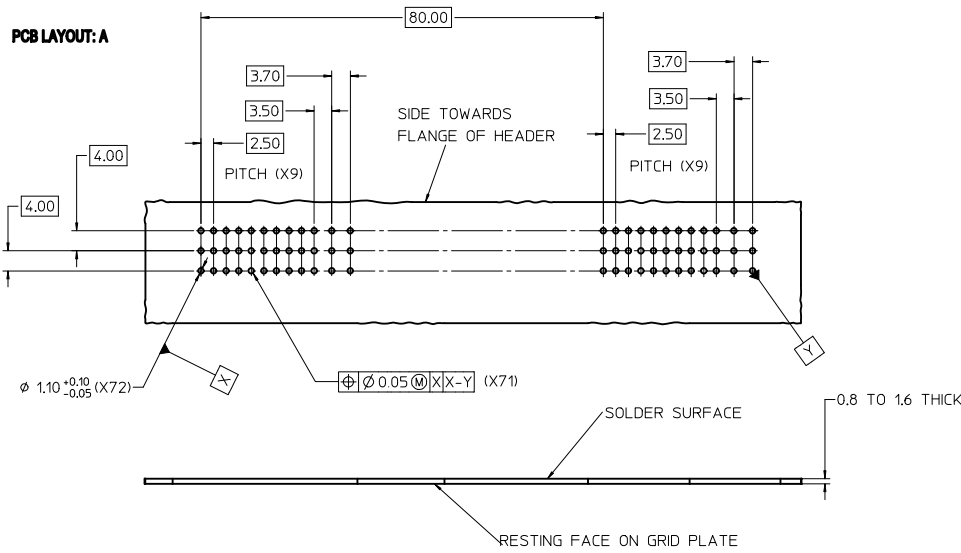

**PCB LAYOUT: B**

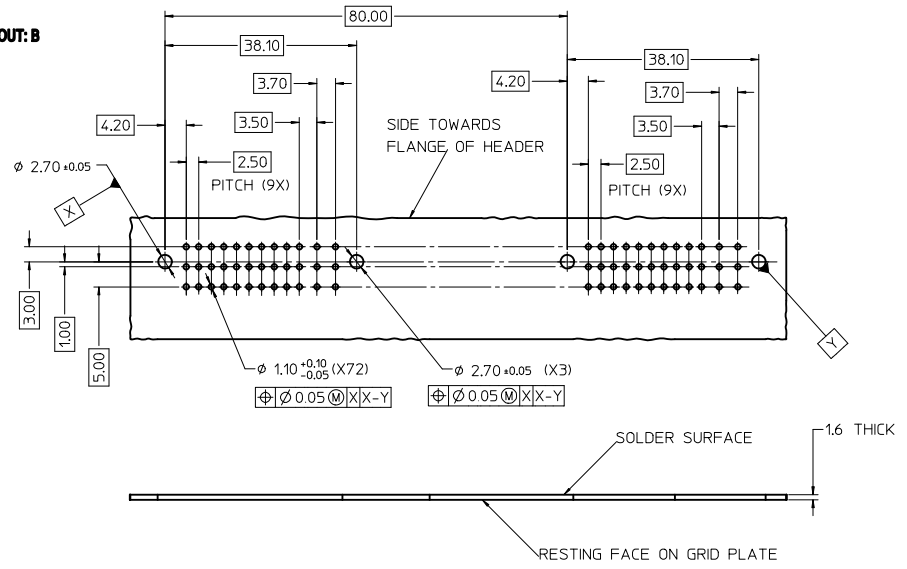

**PCB LAYOUT: C**

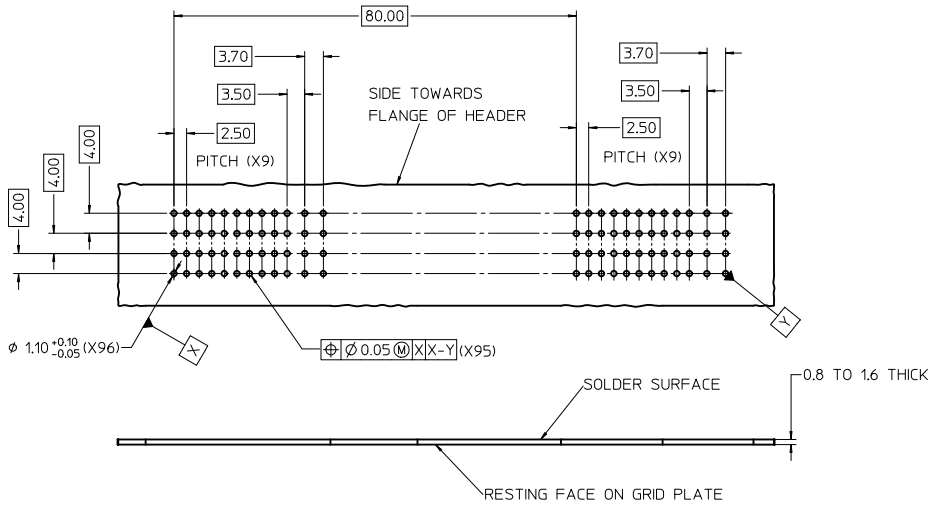

**PCB LAYOUT: D**

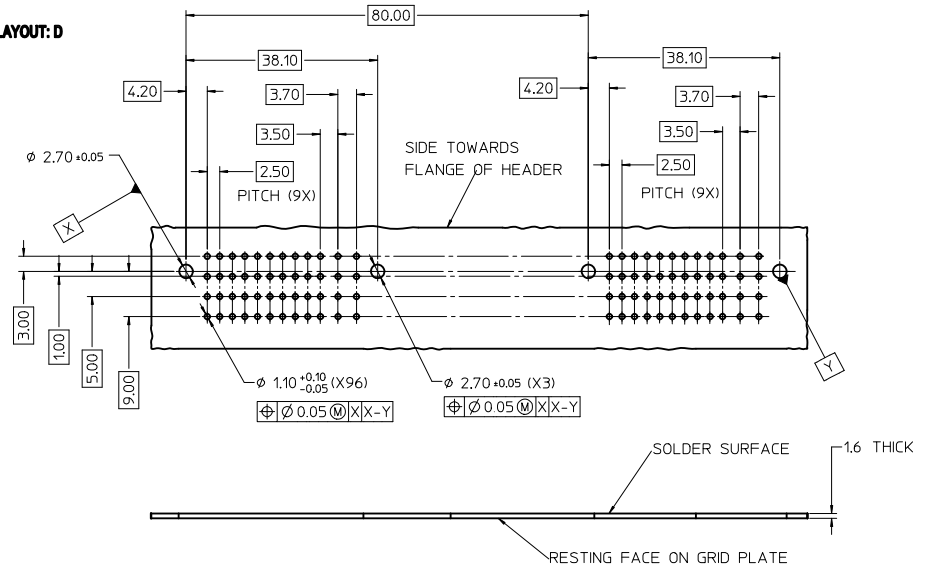

**RoHS COMPLIANT**

<b>ENTER DESCRIPTION</b> EC NO: 2012-0253 DRAWN BY: DRW:VITARRAR CHKD: APPR:KPRASAD 2012/02/15	QUALITY SYMBOLS ▽=0 ▽=0	GENERAL TOLERANCES (UNLESS SPECIFIED) mm INCH 4 PLACES ± --- ± --- 3 PLACES ± --- ± --- 2 PLACES ± 0.1 ± --- 1 PLACE ± 0.2 ± --- ANGULAR ± 1 °	DIMENSION STYLE <b>MM ONLY</b>	SCALE <b>2:1</b>	DESIGN UNITS <b>METRIC</b>	THIRD ANGLE PROJECTION	
	DRAWN BY: DKUMAR DATE: 20/12/2005	CHECKED BY: KPRASAD DATE: 20/12/2005	APPROVED BY: GJLOWE DATE: 20/12/2005	MATERIAL NO. <b>SEE TABLE</b>	DOCUMENT NO. <b>SD-36638-001</b>	TITLE <b>CMC HEADER T3 INTERFACE - BK &amp; BR 96/72 AND 96/96</b>	SHEET NO. <b>3 OF 3</b>
	MOLEX INCORPORATED						
	THIS DRAWING CONTAINS INFORMATION THAT IS PROPRIETARY TO MOLEX INCORPORATED AND SHOULD NOT BE USED WITHOUT WRITTEN PERMISSION						