



ORIGINAL	①
ADD IN NOTES RATED CURRENT & VOLTAGE R.STA.MONICA APR.27/2016	②
PINOUT ADDED N.SONDH MAR.21/2017	③
ADD DETAIL A P.M. JAN. 21/2020	④

TOLERANCE UNLESS OTHERWISE

SPECIFIED IN MM:

0.0 ± 0.20

0.00 ± 0.10

0.000 ± 0.05

ANGLE x°

THIS IS A C.A.D. GENERATED DRAWING

DO NOT MAKE MANUAL REVISIONS TO MASTER.

DETAIL A

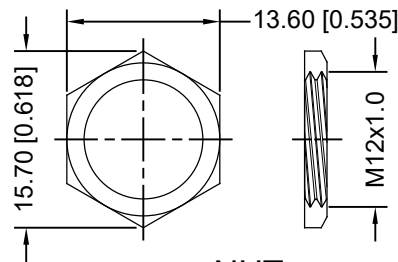
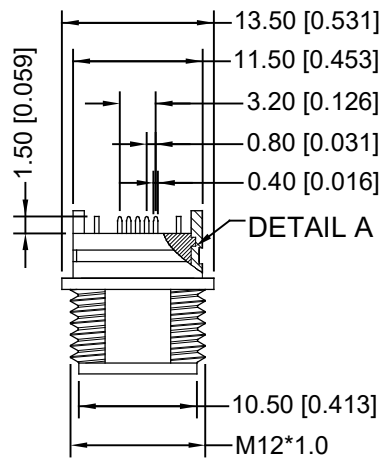
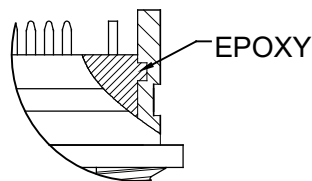

NUT

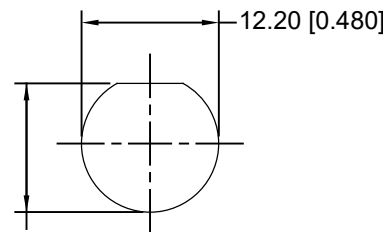

CUT OUT

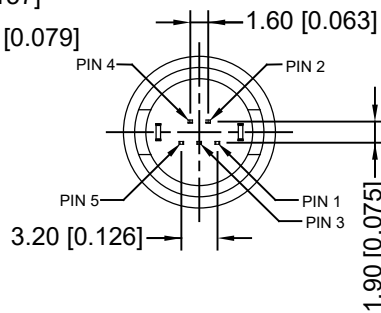
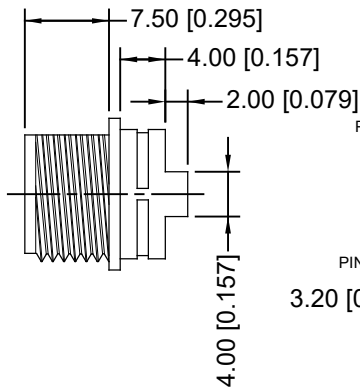
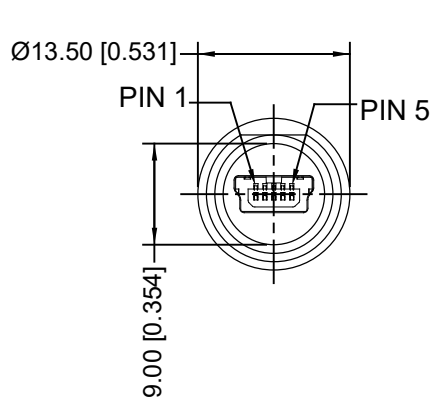
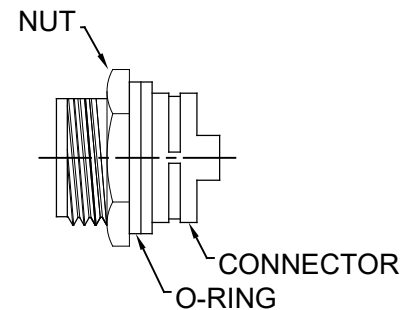

1. MATERIAL :

- 1-1 . HOUSING : LCP UL94V-0 ; COLOR : BLACK
- 1-2 . CONTACT : PHOSPHOR BRONZE
- 1-3 . SHELL : BRASS

2. PARTS

- 2-1 . EXTERNAL NUT : PBT UL 94V-0 ; COLOR : BLACK
- 2-2 . O-RING : EPDM (1.5*9.5) ; COLOR : BLACK.

3. PLATING

- 3-1 . CONTACT : GOLD PLATING ON CONTACT AREA
BRIGHT TIN ON SOLDER AREA
- 3-2 . SHELL : NICKEL PLATING ON OVER ALL

4. SPECIFICATIONS :

- 4-1. Water proof: IP67
- 4-2. Rated Current: 1A
- 4-3. Rated Voltage: 30V

5. OPERATING TEMPERATURE:-25C TO +85C



THIS SERIES FULLY CONFORMS TO THE EUROPEAN UNION DIRECTIVES 2011/65/EU FOR RoHS COMPLIANCE.



EDAC INC
TORONTO, ONTARIO
CANADA

YOUR CONNECTION TO QUALITY & SERVICE

THESE DRAWINGS AND SPECIFICATIONS ARE THE PROPERTY OF EDAC INC., AND SHALL NOT BE REPRODUCED, OR COPIED OR USED AS THE BASIS FOR THE MANUFACTURE OR SALE OF APPARATUS WITHOUT WRITTEN PERMISSION.

WATERPROOF MINI USB TYPE B, 5P (FEMALE)

ACAD REFERENCE NO.: 690-W05-260-044

DRAWN: R.STA.MONICA

DATE: MAY.01/2014

CHECKED: R.S.M.

DATE: JAN. 21/2020

PART NUMBER

690-W05-260-044

SHEET 1 OF 1

DRAWING NUMBER

690-W05-260-044

ISSUE

4