

DO NOT SCALE FROM THIS PRINT

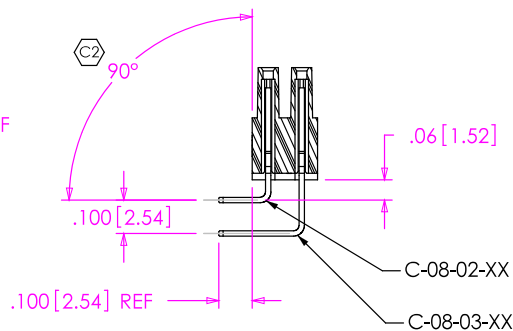

SECTION "A"- "A"

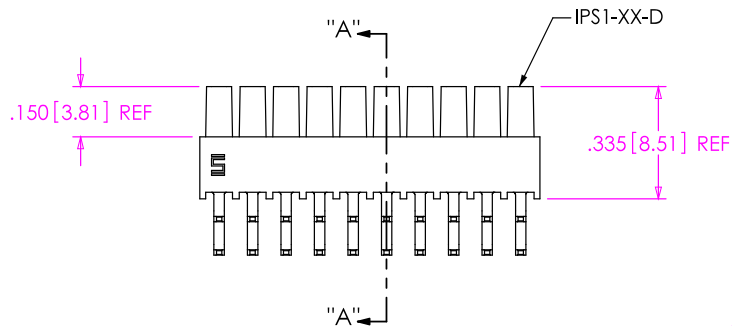
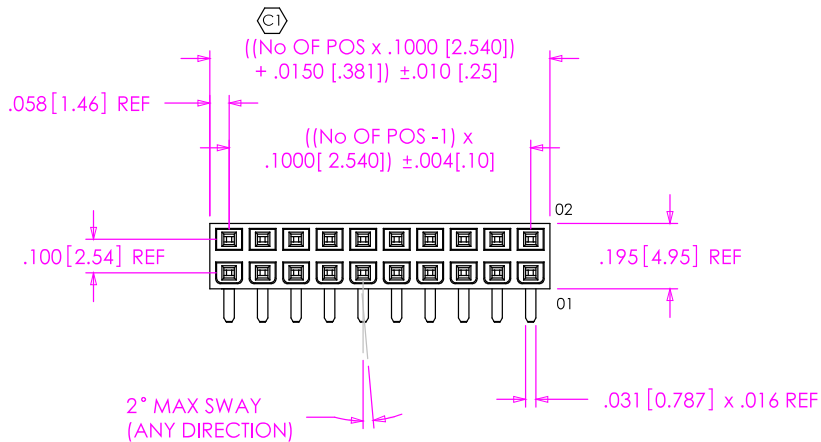
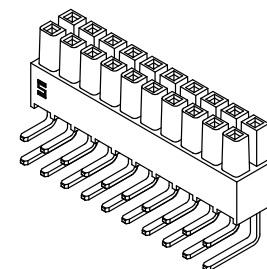

NOTES:

1. $\text{\textcircled{C}}$ REPRESENTS A CRITICAL DIMENSION.
2. MAXIMUM ALLOWABLE CUT FLASH: .010.
3. MINIMUM CONTACT PUSH OUT FORCE: 1.5 lbs.
4. MAXIMUM ALLOWABLE BOW: .003 INCH/INCH AFTER ASSEMBLY.

* = NOT RELEASED

-FL: FRICTION LOCK OPTION

IPS1-110-01-X-D-RA-FL SHOWN

* NOT RELEASED

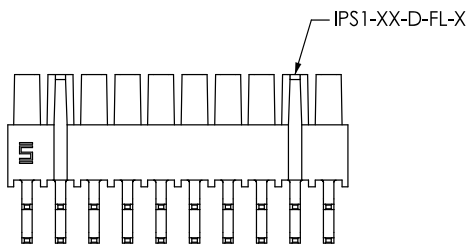

-POL: POLARIZED OPTION

IPS1-110-01-X-D-RA-POL SHOWN

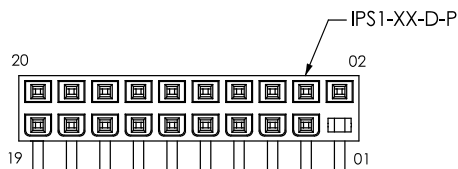

PACKAGING VIEW

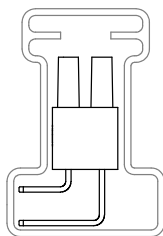

TUBE: PT-1-24-03-44
PLUG: TP-03

IN-PROCESS 1

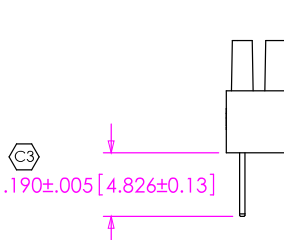

IN-PROCESS 2

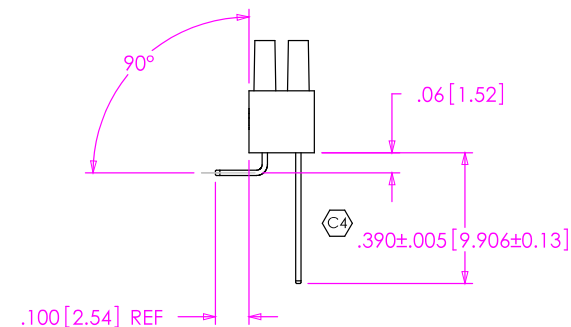

UNLESS OTHERWISE SPECIFIED, DIMENSIONS ARE IN INCHES.

TOLERANCES ARE:
 DECIMALS ANGLES
 .XX: $\pm .01$ $\pm 2^\circ$
 .XXX: $\pm .005$
 .XXXX: $\pm .0020$

PROPRIETARY NOTE

THIS DOCUMENT CONTAINS INFORMATION CONFIDENTIAL AND PROPRIETARY TO SAMTEC, INC. AND SHALL NOT BE REPRODUCED OR TRANSFERRED TO OTHER DOCUMENTS OR DISCLOSED TO OTHERS OR USED FOR ANY PURPOSE OTHER THAN THAT WHICH IT WAS OBTAINED WITHOUT THE EXPRESSED WRITTEN CONSENT OF SAMTEC, INC.

SAMTEC

520 PARK EAST BLVD. NEW ALBANY, IN 47150
 * PHONE: 812.944.6733 FAX: 812.948.5047
 e-Mail: INFO@SAMTEC.COM CODE: 55322

MATERIAL: DO NOT SCALE DRAWING
 INSULATOR: VECTRA E130i, COLOR: BLACK
 CONTACT: PHOS BRONZE, 510 SPRING TEMPER

SHEET SCALE: 1.75:1

DESCRIPTION:
 .100 DOUBLE ROW SHROUDED SOCKET ASSEMBLY

DWG. NO.
IPS1-1XX-XX-XX-D-RA-XXX

BY: DEAN P 03/08/2000 SHEET 1 OF 1