

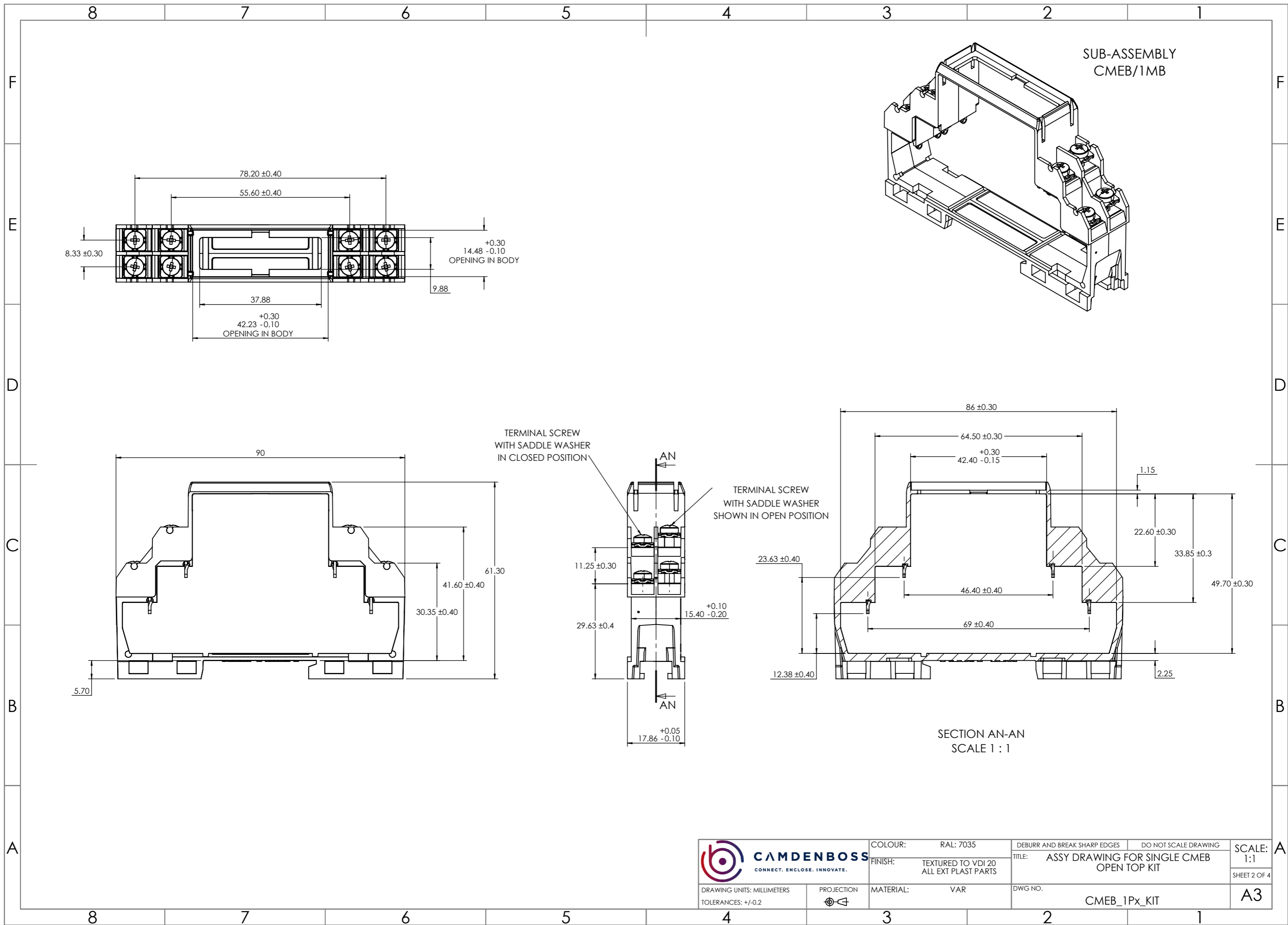



						COLOUR: RAL: 7035	DEBURR AND BREAK SHARP EDGES	DO NOT SCALE DRAWING	SCALE: 1:1 SHEET 1 OF 4 A3
						FINISH: TEXTURED TO VDI 20 ALL EXT PLAST PARTS	TITLE: ASSY DRAWING FOR SINGLE CMEB OPEN TOP KIT		
0.0	26/04/21		FIRST DRAWN	I.PAGANO	S.HARDINGE	DRAWING UNITS: MILLIMETERS	PROJECTION	MATERIAL: VAR	DWG NO.
REVISION	DATE	ECR	DESCRIPTION	NAME	CHK'D	TOLERANCES: +/-0.2			CMEB_1Px_KIT



 CAMDENBOSS CONNECT. ENCLOSE. INNOVATE.	COLOUR: RAL: 7035	DEBURR AND BREAK SHARP EDGES	DO NOT SCALE DRAWING	SCALE: 1:1 SHEET 2 OF 4
	FINISH: TEXTURED TO VDI 20 ALL EXT PLAST PARTS	TITLE: ASSY DRAWING FOR SINGLE CMEB OPEN TOP KIT		
DRAWING UNITS: MILLIMETERS TOLERANCES: +/-0.2	PROJECTION 	MATERIAL: VAR	DWG NO. CMEB_1Px_KIT	A3

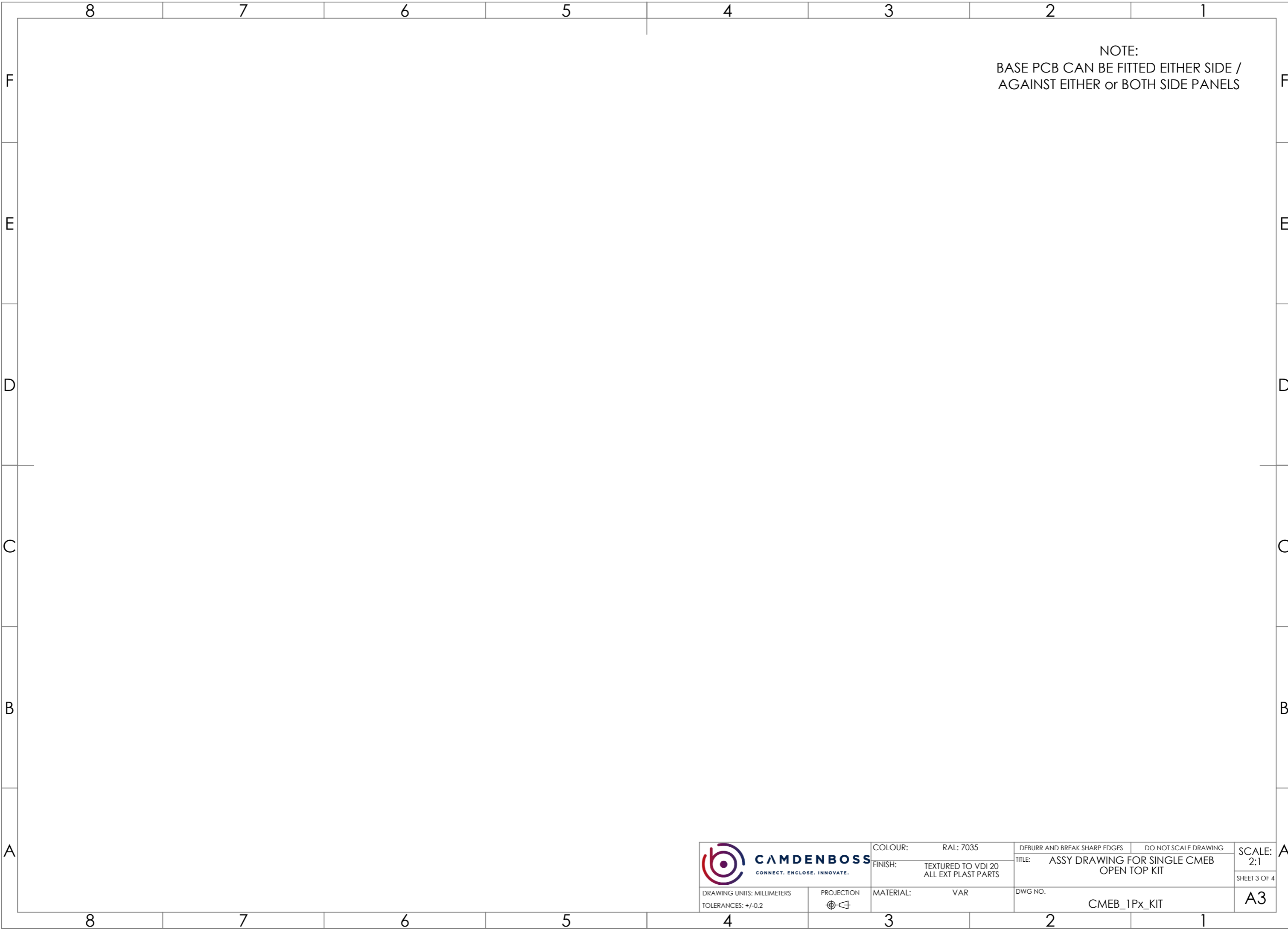

NOTE:
 BASE PCB CAN BE FITTED EITHER SIDE /
 AGAINST EITHER or BOTH SIDE PANELS

 CAMDENBOSS <small>CONNECT. ENCLOSE. INNOVATE.</small>	COLOUR: RAL: 7035	DEBURR AND BREAK SHARP EDGES	DO NOT SCALE DRAWING	SCALE: 2:1 <small>SHEET 3 OF 4</small>
	FINISH: TEXTURED TO VDI 20 ALL EXT PLAST PARTS	TITLE: ASSY DRAWING FOR SINGLE CMEB OPEN TOP KIT		
DRAWING UNITS: MILLIMETERS TOLERANCES: +/-0.2	PROJECTION 	MATERIAL: VAR	DWG NO. CMEB_1Px_KIT	A3

BASE PCB OPEN TOP BODY
FITTED WITH CNMB/Px TOP

NOTCH IN TOP OF PCB
TO CLEAR CLIP ON CNMB/1/PX TOP

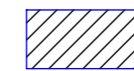
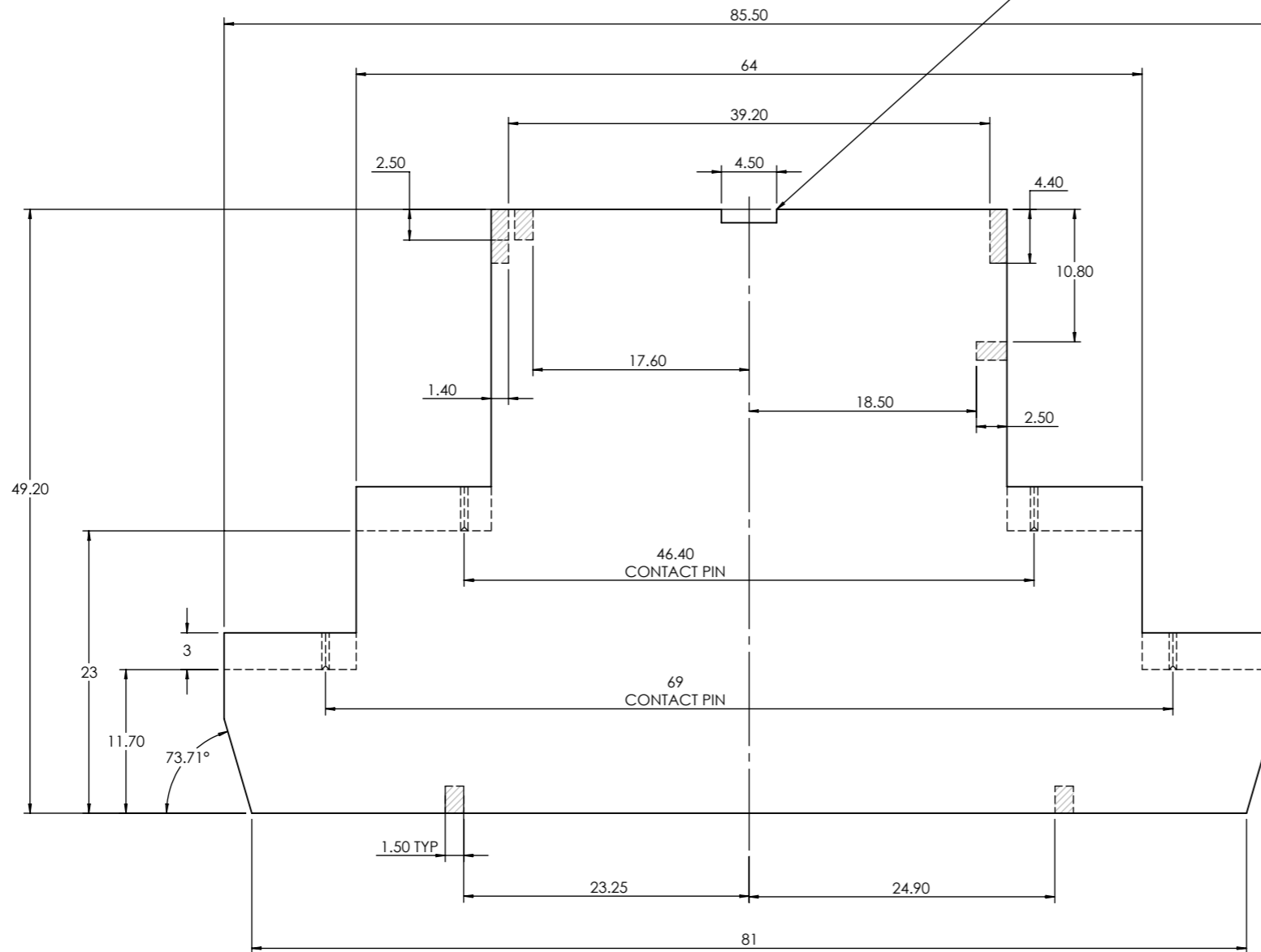

ENCLOSURE TO PCB CONTACT
ON UNDERSIDE OF FACE SHOWN



DRAWING UNITS: MILLIMETERS
TOLERANCES: +/-0.2

PROJECTION

COLOUR: RAL: 7035
FINISH: TEXTURED TO VDI 20
ALL EXT PLAST PARTS
MATERIAL: VAR

DEBURR AND BREAK SHARP EDGES
DO NOT SCALE DRAWING
TITLE: ASSY DRAWING FOR SINGLE CMEB
OPEN TOP KIT
DWG NO. CMEB_1Px_KIT

SCALE:
2:1
SHEET 4 OF 4
A3