

PCB Layout (Component Side)

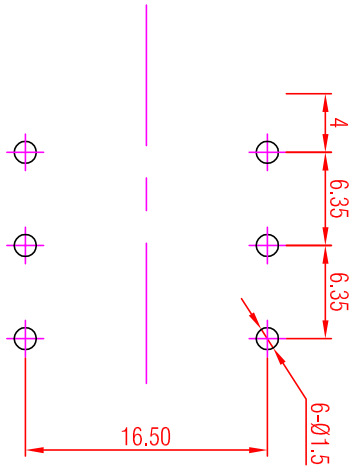

Washer

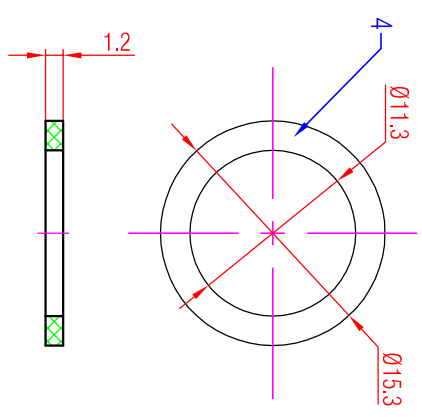

Nut

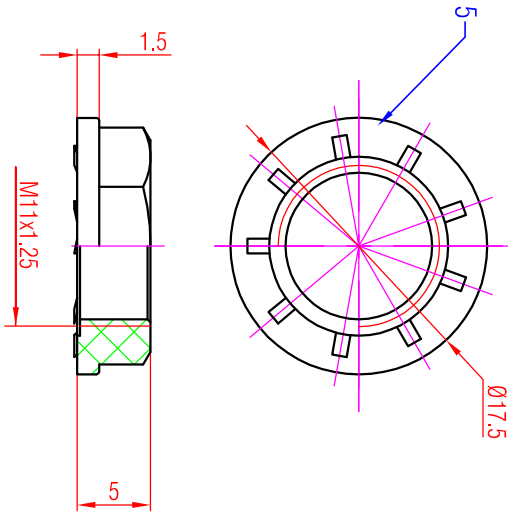

Panel Cut Out (Rear Side)

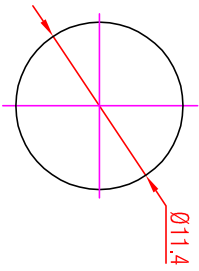

- Note:
1. All dimensions in mm.
 2. Tolerances not specified is $\pm 0.10\text{mm}$.
 3. Radius not specified is $R=0.20\text{mm}$.

5	Nut	PA6 + 30% GF (Black)
4	Washer	ABS (Black)
3	Housing	PA6 + 30% GF (Black)
2	Switched Contact	Phosphor Bronze, Tin-Cer Plated
1	Normalizing Contact	Brass, Tin-Cer Plated
No.	Part Name	Material

THIS DOCUMENT IS THE PROPERTY OF HEINRICH NO PART THEREOF MAY BE REPRODUCED AND USED WITHOUT THE PRIOR WRITTEN CONSENT OF THE OWNER		Material:	Scale:	Designer:	Date:	Name:
			2 : 1	Checked:	2015.05.28	James
				Approved:	2015.05.28	Abraham
				Replaced By:		1
				Replaces:		1
				Drawing No.:		
				1/4" Phone Stereo Jacks NYS218		