

THIS DRAWING IS UNPUBLISHED. RELEASED FOR PUBLICATION .19
 © COPYRIGHT 19 BY AMP INCORPORATED. ALL RIGHTS RESERVED.

LOC	DIST	REVISIONS			
P	LTR	DESCRIPTION	DATE	DWN	APVD
DY	-	AI REVISED PER ECR-09-016366	22JUL2009	SYJ	LSF

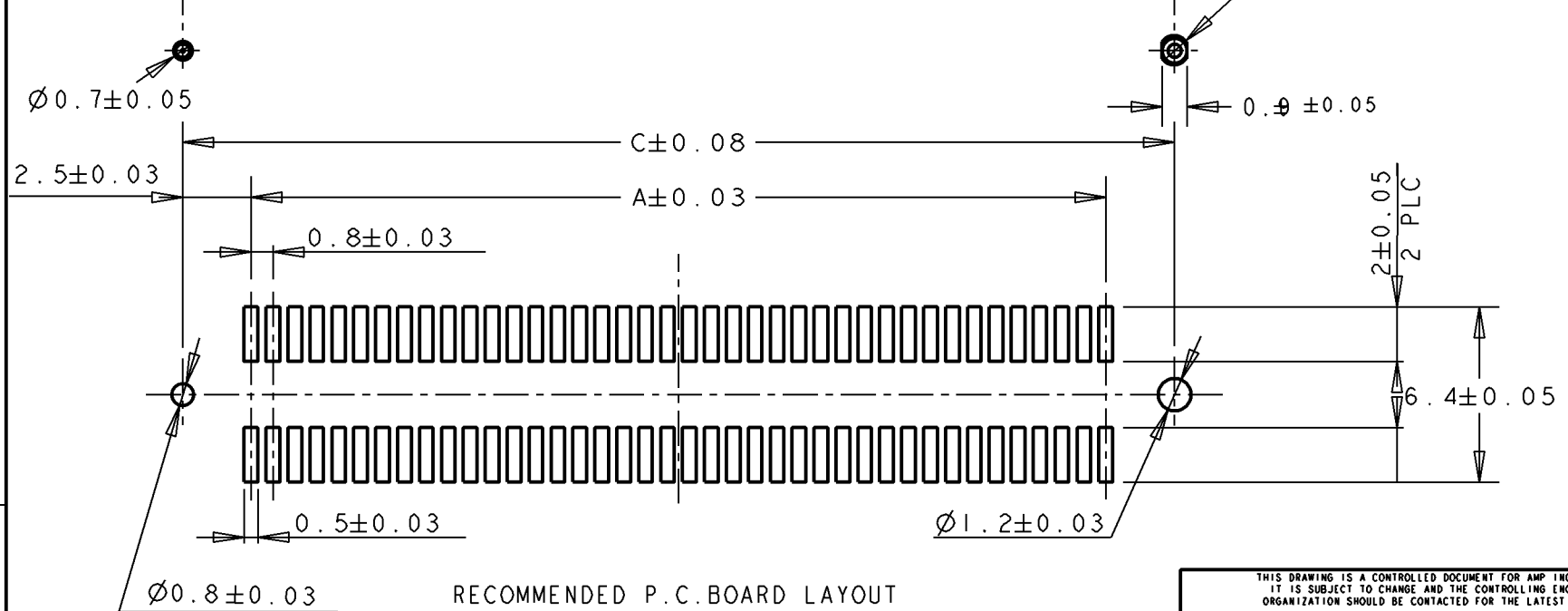
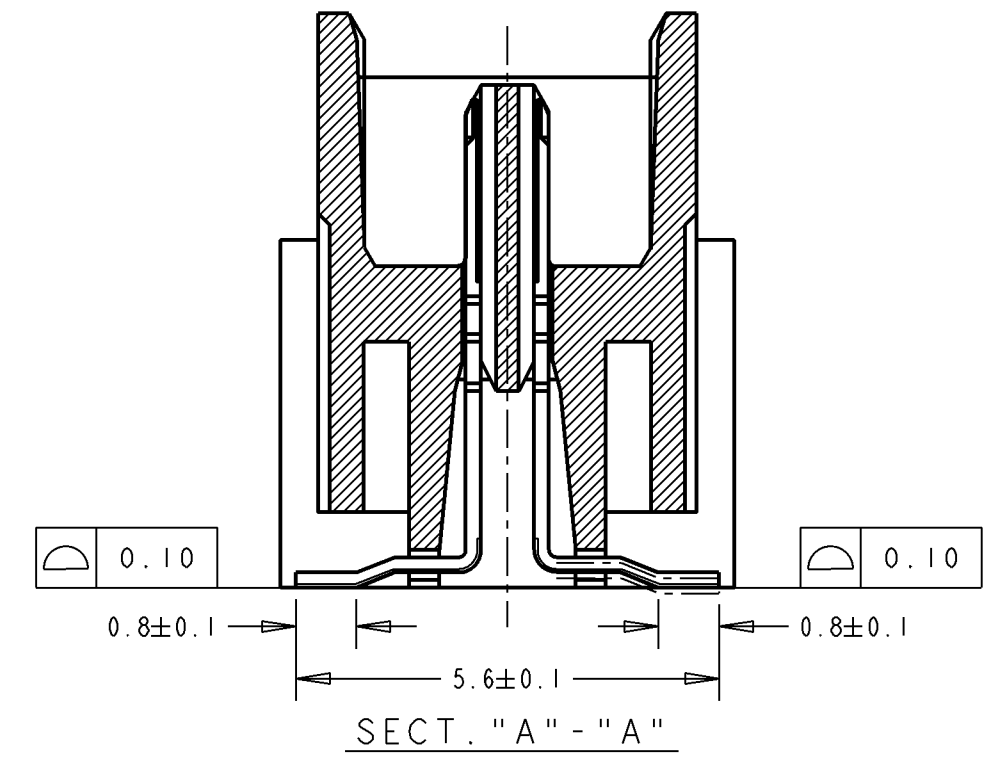
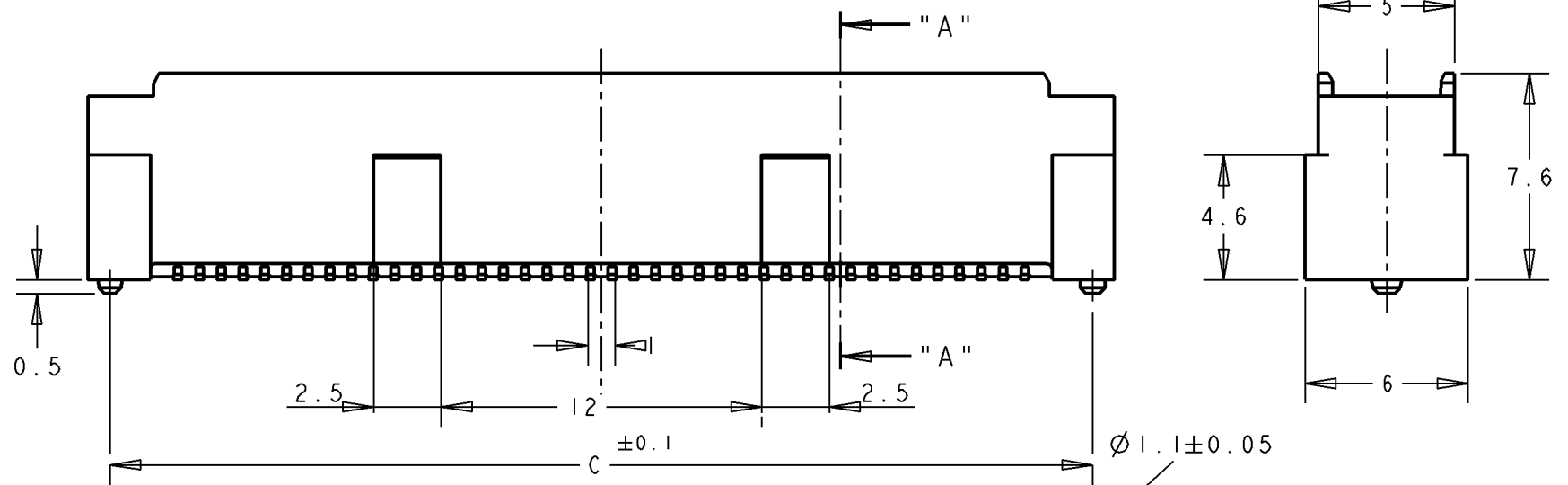
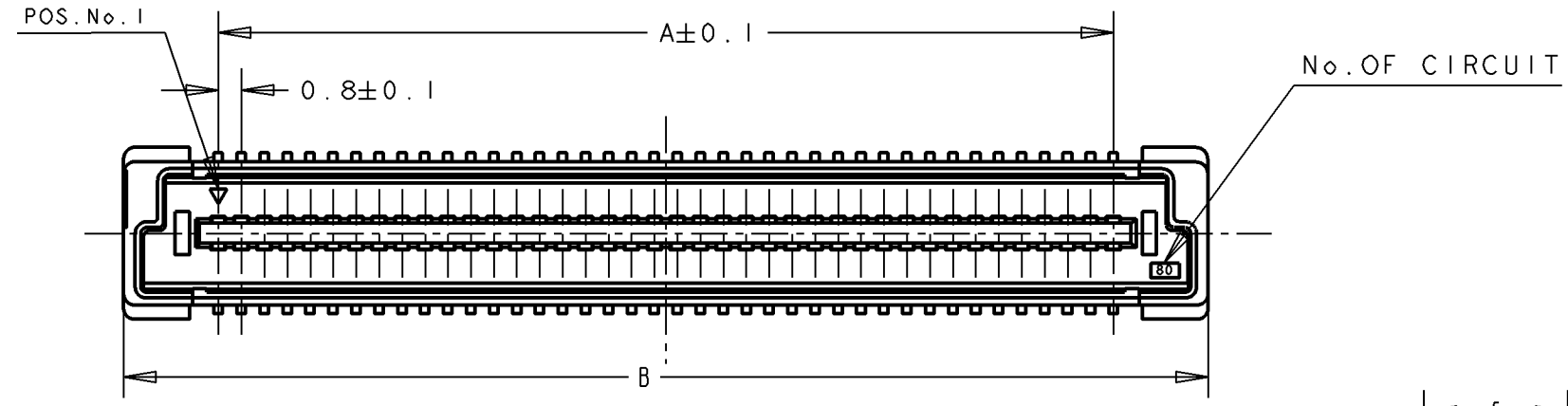

- NOTES:
- 1. MATERIAL:
HOUSING: L.C.P.(HIGH TEMP THERMO PLASTIC)
UL 94V-0, NATURAL.
CONTACT: BRASS.
 - 2. FINISH:
CONTACT AREA: 0.0002 MIN GOLD
SOLDERING AREA: 0.0020 MIN MATTE-TIN
UNDERPLATE: 0.0013 MIN NICKEL ALL OVER
 - 3. POSITION SERIES: SEE TABLE.
 - 4. CONN STACK HEIGHT COMBINE OF PLUG "Y"H VS REC "X"H.
STACK HEIGHT = Y + X - 5

RECOMMENDED P.C. BOARD LAYOUT

THIS DRAWING IS A CONTROLLED DOCUMENT FOR AMP INCORPORATED. IT IS SUBJECT TO CHANGE AND THE CONTROLLING ENGINEERING ORGANIZATION SHOULD BE CONTACTED FOR THE LATEST REVISION.		DWN FLORENCE TAN 28JUL04	Tyco Electronics Corporation Singapore	
DIMENSIONS: mm		CHK ERIC TNG	NAME PLUG ASSEMBLY 8H TYPE (0.5 BOSS LENGTH) FOR FH 0.8MM PITCH B-T-B CONNECTOR	
TOLERANCES UNLESS OTHERWISE SPECIFIED: 0 PLC ±. 1 PLC ±0.30 2 PLC ±0.25 3 PLC ±0.20 4 PLC ±. ANGLES ±3°		APVD SEIFONG	DRAWING NO C=5179031	
MATERIAL		PRODUCT SPEC 108-5390	SIZE A3	CAGE CODE 00779
FINISH		APPLICATION SPEC 114-5254	SCALE 4:1	
CUSTOMER DRAWING		WEIGHT -	SHEET 1 OF 2	
		REV A1		

THIS DRAWING IS UNPUBLISHED. RELEASED FOR PUBLICATION .19
 BY AMP INCORPORATED. ALL RIGHTS RESERVED.

LOC	DIST	REVISIONS					
DY	-	P	LTR	DESCRIPTION	DATE	DWN	APVD
				SEE SHEET 1			

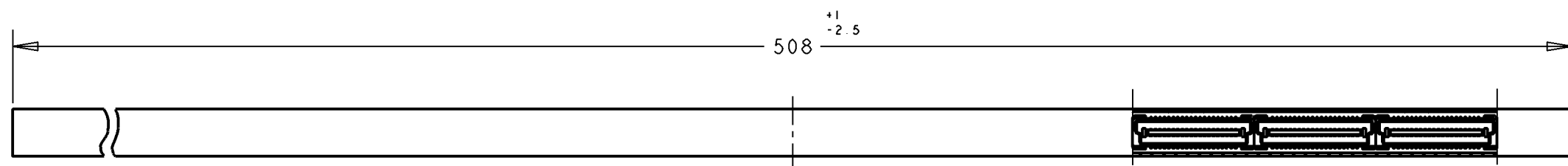

SECT A-A



SECT B-B

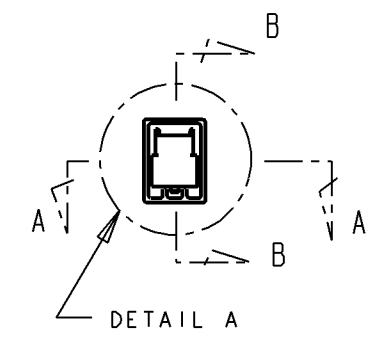

REFERENCE PICTURE OF TUBE PACK

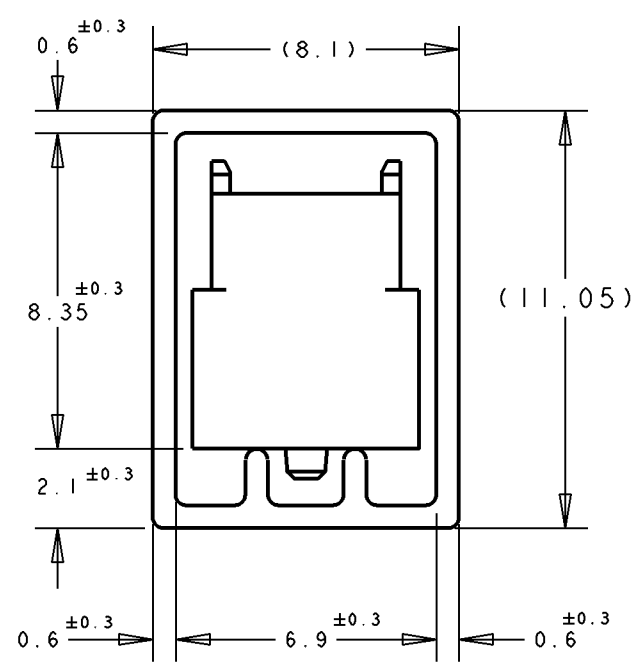

DETAIL "B"
(SCALE 5-1)

36	12.2	13.8	7.2	20	1-	-3
11	40.2	41.8	35.2	90	1-	-2
14	32.2	33.8	27.2	70	1-	-1
5	84.2	85.8	79.2	200	1-	-0
6	76.2	77.8	71.2	180		-9
6	68.2	69.8	63.2	160		-8
7	60.2	61.8	55.2	140		-6
9	52.2	53.8	47.2	120		-5
10	44.2	45.8	39.2	100		-4
12	36.2	37.8	31.2	80		-3
16	28.2	29.8	23.2	60		-2
22	20.2	21.8	15.2	40		5179031-1
QTY/TUBE	C	B	A	POS.	CONN P/N	

THIS DRAWING IS A CONTROLLED DOCUMENT FOR AMP INCORPORATED. IT IS SUBJECT TO CHANGE AND THE CONTROLLING ENGINEERING ORGANIZATION SHOULD BE CONTACTED FOR THE LATEST REVISION.		DWN FLORENCE 28JUL04	Tyco Electronics Corporation Singapore	
DIMENSIONS: mm		CHK ERIC TNG	NAME PLUG ASSEMBLY 8H TYPE (0.5 BOSS LENGTH) FOR FH 0.8MM PITCH B-T-B CONNECTOR	
TOLERANCES UNLESS OTHERWISE SPECIFIED: 0 PLC ± 1 PLC ±0.30 2 PLC ±0.25 3 PLC ±0.20 4 PLC ± ANGLES ±3°		APVD SEIFONG	DRAWING NO C=5179031	
MATERIAL		PRODUCT SPEC 108-5390	SIZE A3	CAGE CODE 00779
FINISH		APPLICATION SPEC 114-5254	SCALE 4:1	
		WEIGHT -	SHEET 2 OF 2	
		CUSTOMER DRAWING	REV A1	