

© 1988 日本エー・エム・ピー株式会社
AMP 社の商標品は特許又は特許出願中

© 1988 BY AMP (Japan) Ltd.
ALL RIGHTS RESERVED AMP
PRODUCTS COVERED BY PATENTS
AND/OR PATENTS PENDING

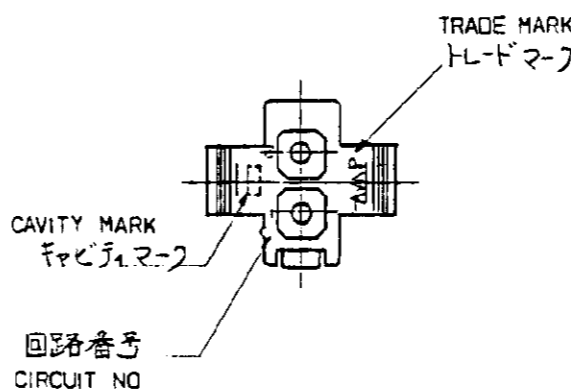

- NOTES:
1. APPLIED CONTACT P/N : 170359, 170360, 170361, 170362, 171636, 171637
 2. MATING CONN : PLUG HOUSING P/N 172336
 - △ PANEL THICKNESS : 0.8 ~ 2.0mm
 4. PRESS DIRECTION OF PANEL MUST BE SAME AS HOUSING INSERTED DIRECTION.
 5. INSTRUCTION SHEET : IS - 105J
 6. PRODUCT SPEC : 108 - 5151

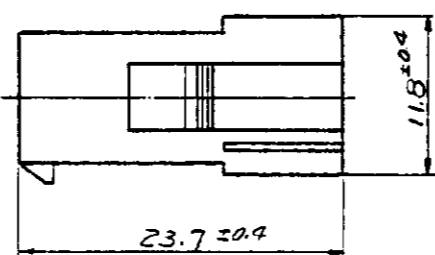
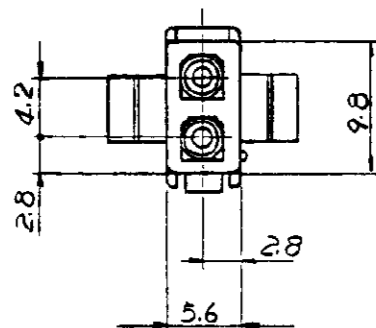
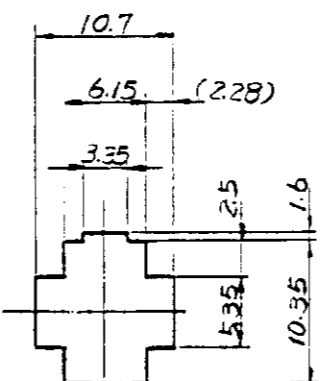
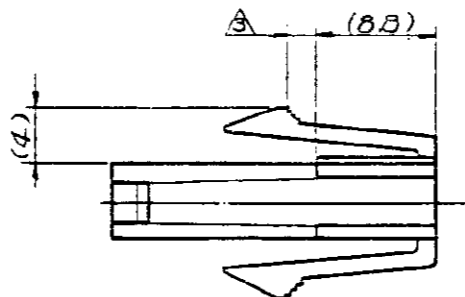

寸法公差は ±0.20
(TOLERANCE : ±0.2)
穴の取付穴
(DIMENSION OF PANEL)

- 注:
1. 使用端子型番は 170359, 170360, 170361, 170362, 171636, 171637.
 2. 嵌合相手ハウジング型番は 172336
 - △ 適用パネル厚は 0.8 ~ 2.0mm.
 4. 取付穴打抜方向とハウジングの挿入方向は同じとする.
 5. 取扱説明書 : IS-105J
 6. 適用製品仕様書 : 108-5151
 7. 端子とハウジング端面間の絶縁材料 (F) は下記参照.

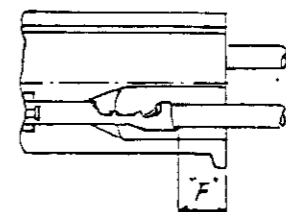

F mm	端子型番
3.2	170359 ~ 170362
2.5	171636, 171637

色 (COLOR)	型番 (P/N)
黄 (YELLOW)	1-172328-4
黒 (BLACK)	1-172328-9
青 (BLUE)	1-172328-6
緑 (GREEN)	1-172328-5
赤 (RED)	1-172328-2
自然色 (NATURAL)	172328-1

#12 : ALL DIMENSIONS IN MM. DO NOT SCALE PRINT

LTR.	変更 (REVISION RECORD)	DR.	CHK.	DATE
B1	黄色追加 J-10297	F.O.	10/6	9/6/88
B	変更 J-9972	KA	10/14	9/7
A	追加 J84-7842	MI	10/15	9/20
O1	変更 J81-5998	XY	11/1	9/21
O	作成 J80-5788	XY	11/1	8/30

材料 (MATERIAL) 6/6 ナイロン (UL94V-2) (NYLON 6/6 UL94V-2)	一般公差 TOLERANCE ± 0.3 EXCEPT ± 1.0 AS NOTED	 日本エー・エム・ピー株式会社 TOKYO, JAPAN 名称 (NAME): MINI UNIVERSAL MATE-N-LOK CONN. CAP HOUSING 2 Pos. (UL94V-2) 2極 ミニユニバーサルメイトンロックコネクタ キャップハウジング (UL94V-2)
仕上 (FINISH) 色: 表参照 HOUSING: SEE TABLE COLOR	DR. R. Uchida 10/8/81 CHK. J. Taniguchi 4/20/81 DE. J. Taniguchi 4/20/81 APP.	
SIZE LOC 番号 (NO.) B J C-172328		尺度 (SCALE) REV. SHEET 2:1 B1