

SECTION Z-Z

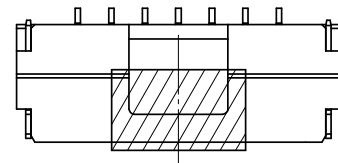

カプトンテープ付き
WITH KAPTON TAPE

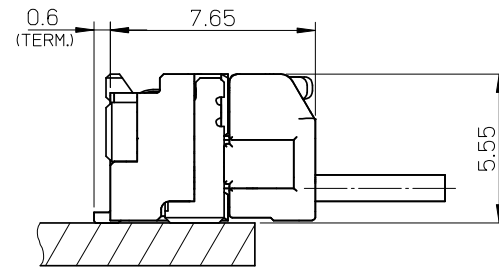
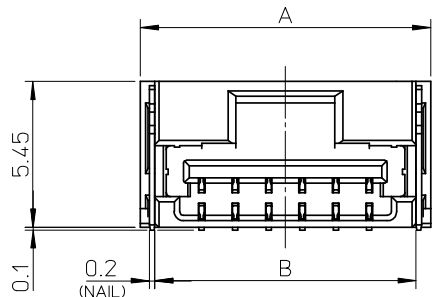
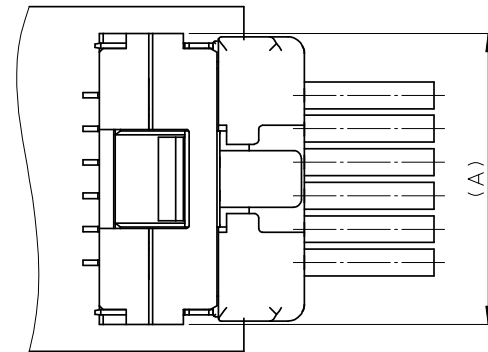

嵌合図

MATED CONNECTORS

NOTES

- 嵌合相手: 502380-****
MATE WITH: 502380-****
- 端子テール部 及び ネイルの平坦度: 0.1MAX.
TAIL AND NAIL COPLANARITY TO BE 0.1 MAX.
- 極数/2=偶数に適用。
APPLY FOR CKT. SIZE / 2 = EVEN.
- 端子テール部 及び ネイルに錫めっきを使用しているため、
外観に摺動痕が付く場合が御座います。
THE WOUND OF FRICTION MIGHT ADHERE TO EXTERNALS
BECAUSE THE TIN PLATING IS USED FOR THA TAIL AND NAIL.
- 本製品のプラスチック部に黒点等が確認される場合や
色合いが異なる場合がありますが、製品性能に影響はありません。
THERE IS NO INFLUENCE IN THE PRODUCT PERFORMANCE THOUGH
THE BLACK SPOT ETC. MIGHT BE CONFIRMED TO THE PLASTIC PART
OF THIS PRODUCT AND THE SHADE MIGHT BE DIFFERENT.
- ELV 及び RoHS 適合品
ELV AND RoHS COMPLIANT

3.4	7.5	11	12.1	502386-0772	502386-0708	502386-0770	502386-0709	7
3.4	6.25	9.75	10.85	502386-0672	502386-0608	502386-0670	502386-0609	6
3.4	5	8.5	9.6	502386-0572	502386-0508	502386-0570	502386-0509	5
3.4	3.75	7.25	8.35	502386-0472	502386-0408	502386-0470	502386-0409	4
2.6	2.5	6	7.1	502386-0372	502386-0308	502386-0370	502386-0309	3
2.2	1.25	4.75	5.85	502386-0272	502386-0208	502386-0270	502386-0209	2
D	C	B	A	EMBOSSD TAPE PACKAGE オーダー番号 ORDER No.	製品番号 MATERIAL NO.	EMBOSSD TAPE PACKAGE オーダー番号 ORDER No.	製品番号 MATERIAL NO.	極数 (KT. NO.)
				WITH CAPTON TAPE		WITHOUT CAPTON TAPE		

番号 NO.	部品 PART	材質 MATERIAL
①	ハウジング HOUSING	耐熱性樹脂 UL94V-0 色: ナチュラル HEATPROOF RESIN UL94V-0 COLOR:NATURAL
②	ターミナル TERMINAL	銅合金 COPPER ALLOY
		錫めっき: 1.0 micro-meter MIN. TIN (TAIL AREA)
		ニッケルめっき(下地): 1.0 micro-meter MIN. NICKEL (UNDER PLATING)
③	ネイル NAIL	銅合金 COPPER ALLOY
		錫めっき: 1.0 micro-meter MIN. TIN
		ニッケルめっき(下地): 1.0 micro-meter MIN. NICKEL (UNDER PLATING)

REVISED EC NO: J2008-3785 DRW:KASETO 2008/04/30 CHK:KASAKAWA 2008/05/07 APPR: SICHIKAWA 2008/05/07	GENERAL TOLERANCES (UNLESS SPECIFIED)		DIMENSION STYLE MM ONLY		SCALE 5:1	DESIGN UNITS METRIC	THIRD ANGLE PROJECTION	
	10 UNDER	±0.2	DRAWN BY DATE T. MIYAZAKI 2006/08/28		TITLE 1.25 W/B CONN. SINGLE R/A REC. ASS'Y 2-7CKT.			
	10 OVER 30 UNDER	±0.25	CHECKED BY DATE K. ASAKAWA 2006/08/28					
	30 OVER	±0.3	APPROVED BY DATE YO. ITO 2006/08/28		MOLEX INCORPORATED			
ANGULAR ±3 °		MATERIAL NO.		DOCUMENT NO.				
DRAFT WHERE APPLICABLE MUST REMAIN WITHIN DIMENSIONS		SEE TABLE		SD-502386-001		1 OF 2		
THIS DRAWING CONTAINS INFORMATION THAT IS PROPRIETARY TO MOLEX INCORPORATED AND SHOULD NOT BE USED WITHOUT WRITTEN PERMISSION								



2 CKT.



3 CKT.



4 CKT.

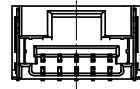
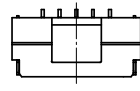

5 CKT.

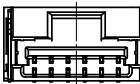
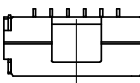

6 CKT.

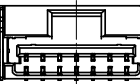
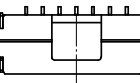

7 CKT.

極数の種類

KIND OF CKT. NO.(FRONT VIEW)

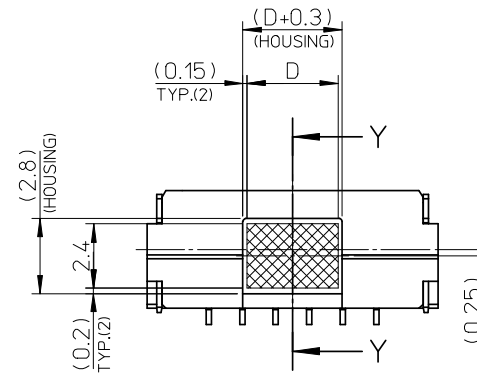

吸着範囲
VACUUM AREA

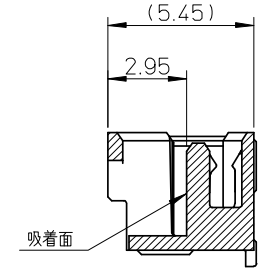

SECTION Y-Y

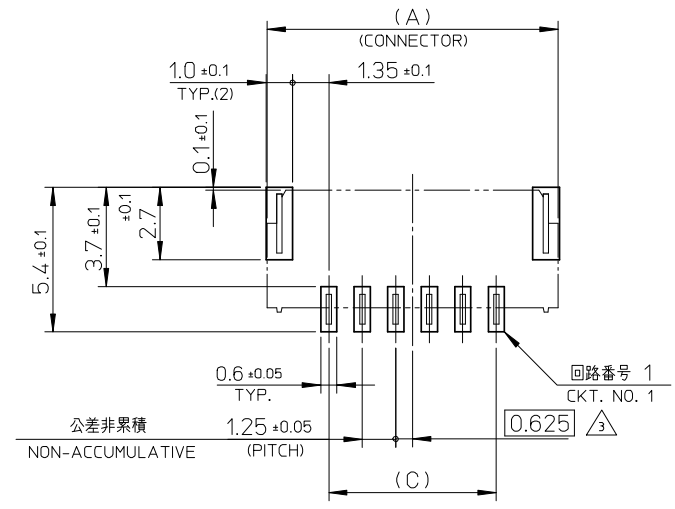

公差非累積
NON-ACCUMULATIVE

基板パターンレイアウト(参考)
RECOMMENDED P.C.B. PATTERN LAYOUT (REF.)

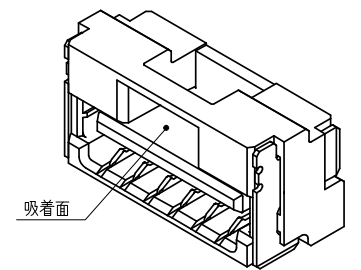

REVISED EC NO: J2008-3785 DRWN:KSETO 2008/04/30 CHK'D:KASAKAWA 2008/05/07 APPR: SICHIKAWA 2008/05/07	GENERAL TOLERANCES (UNLESS SPECIFIED)		DIMENSION STYLE MM ONLY		SCALE 5:1	DESIGN UNITS METRIC	THIRD ANGLE PROJECTION	
	10 UNDER	± 0.2	DRAWN BY T. MIYAZAKI	DATE 2006/08/28	TITLE 1.25 W/B CONN. SINGLE R/A REC. ASS'Y 2-7CKT.			
	10 OVER 30 UNDER	± 0.25	CHECKED BY K. ASAKAWA	DATE 2006/08/28	MATERIAL NO. SEE TABLE			
	30 OVER	± 0.3	APPROVED BY YO. ITO	DATE 2006/08/28	DOCUMENT NO. SD-502386-001			
	ANGULAR	± 3 °	DRAFT WHERE APPLICABLE MUST REMAIN WITHIN DIMENSIONS		SHEET NO. 2 OF 2			

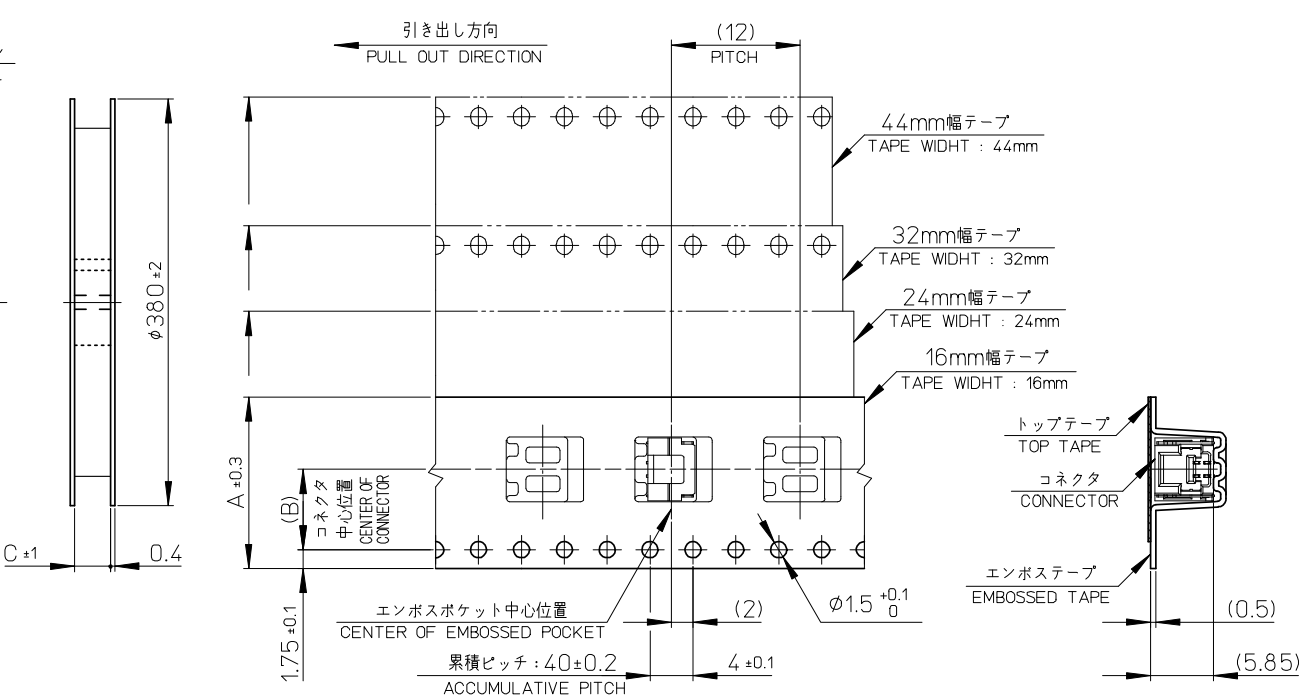
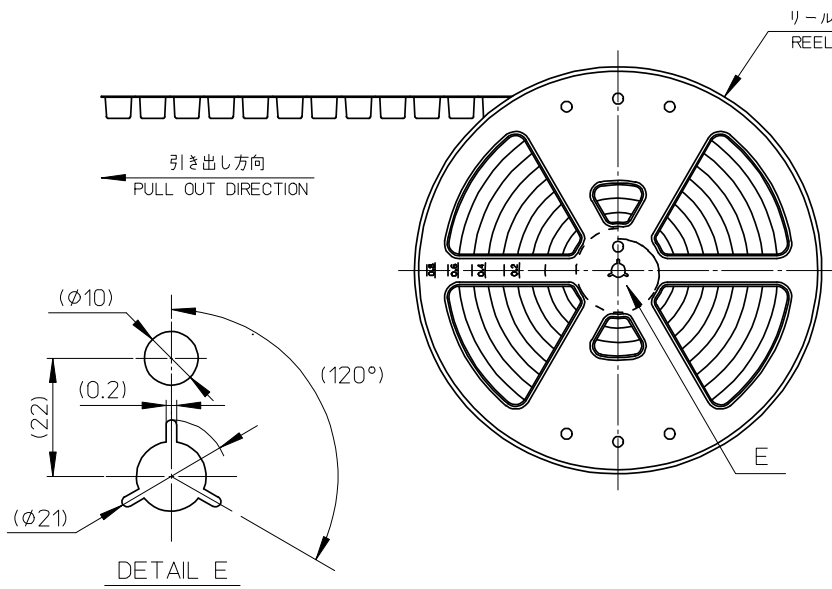

NOTES

- 製品詳細寸法については、SD-502386-001, -002 を参照下さい。
PLEASE REFER TO SD-502386-001, -002 FOR THE DETAILED DIMENSION OF THE CONNECTOR.
- 梱包数量 : 1200個
NUMBER OF CONNECTIONS : 1200 PIECES/REEL.
- リードテープ長さ
LEAD TAPE LENGTH

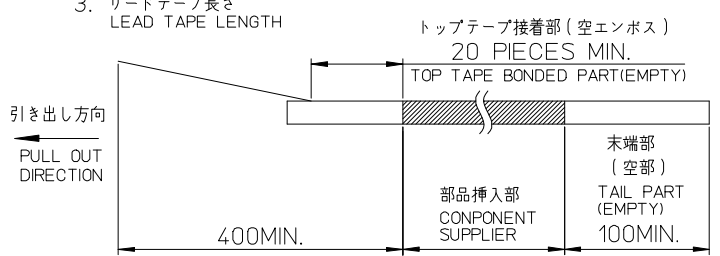

- 材料
MATERIAL
キャリアテープ : ポリスチレン
CARRIER TAPE : POLYSTYRENE
トップテープ : ポリエステル, ポリエチレン, ポリエチレンテレフタレート
TOP TAPE : POLYESTER, POLYETHYLENE, POLYETHYLENE TEREPHTHALATE
リール : ポリスチレン <リサイクル材を含む>
REEL : POLYSTYRENE <RECYCLE MATERIAL CONTAINED>
- ELV 及び RoHS 適合品
ELV AND RoHS COMPLIANT

45.5	20.2	44	—	—	502386-1509	502386-1570	502386-**7*	15	
45.5	20.2	44	—	—	502386-1409	502386-1470		14	
33.5	14.2	32	—	—	502386-1309	502386-1370		13	
33.5	14.2	32	—	—	502386-1209	502386-1270		12	
33.5	14.2	32	—	—	502386-1109	502386-1170		11	
33.5	14.2	32	—	—	502386-1009	502386-1070		10	
25.5	11.5	24	—	—	502386-0909	502386-0970		9	
25.5	11.5	24	—	—	502386-0809	502386-0870		8	
25.5	11.5	24	502386-0708	502386-0772	502386-0709	502386-0770		7	
25.5	11.5	24	502386-0608	502386-0672	502386-0609	502386-0670		6	
25.5	11.5	24	502386-0508	502386-0572	502386-0509	502386-0570		5	
25.5	11.5	24	502386-0408	502386-0472	502386-0409	502386-0470		4	
17.5	7.5	16	502386-0308	502386-0372	502386-0309	502386-0370		3	
17.5	7.5	16	502386-0208	502386-0272	502386-0209	502386-0270		2	
C	B	エンボステープ幅 A WIDTH OF TAPE	コネクタ CONNECTOR	製品番号 MATERIAL NO.	コネクタ CONNECTOR	製品番号 MATERIAL NO.		モデル番号 MODEL NO.	極数 (KT. NO.)

REVISED EC NO: J2008-3866 DRW: KASETO CHK: KASAKAWA APPR: SICHIKAWA 2008/05/12 2008/05/12 2008/05/12	GENERAL TOLERANCES (UNLESS SPECIFIED)		DIMENSION STYLE MM ONLY		SCALE ---	DESIGN UNITS METRIC	THIRD ANGLE PROJECTION	
	10 UNDER	±0.2	DRAWN BY T. MIYAZAKI	DATE 2006/10/16	TITLE 1.25 W/B CONN. SINGLE R/A REC. EMBTP PKG			
	10 OVER 30 UNDER	±0.25	CHECKED BY K. ASAKAWA	DATE 2006/10/16	APPROVED BY YO. ITO			
	30 OVER	±0.3	MATERIAL NO. SEE TABLE		DOCUMENT NO. SD-502386-003		SHEET NO. 1 OF 1	
	ANGULAR ±3 °		DRAFT WHERE APPLICABLE MUST REMAIN WITHIN DIMENSIONS		THIS DRAWING CONTAINS INFORMATION THAT IS PROPRIETARY TO MOLEX INCORPORATED AND SHOULD NOT BE USED WITHOUT WRITTEN PERMISSION			