

890-406 to 890-431

CLIPPER Industrial plastic connectors

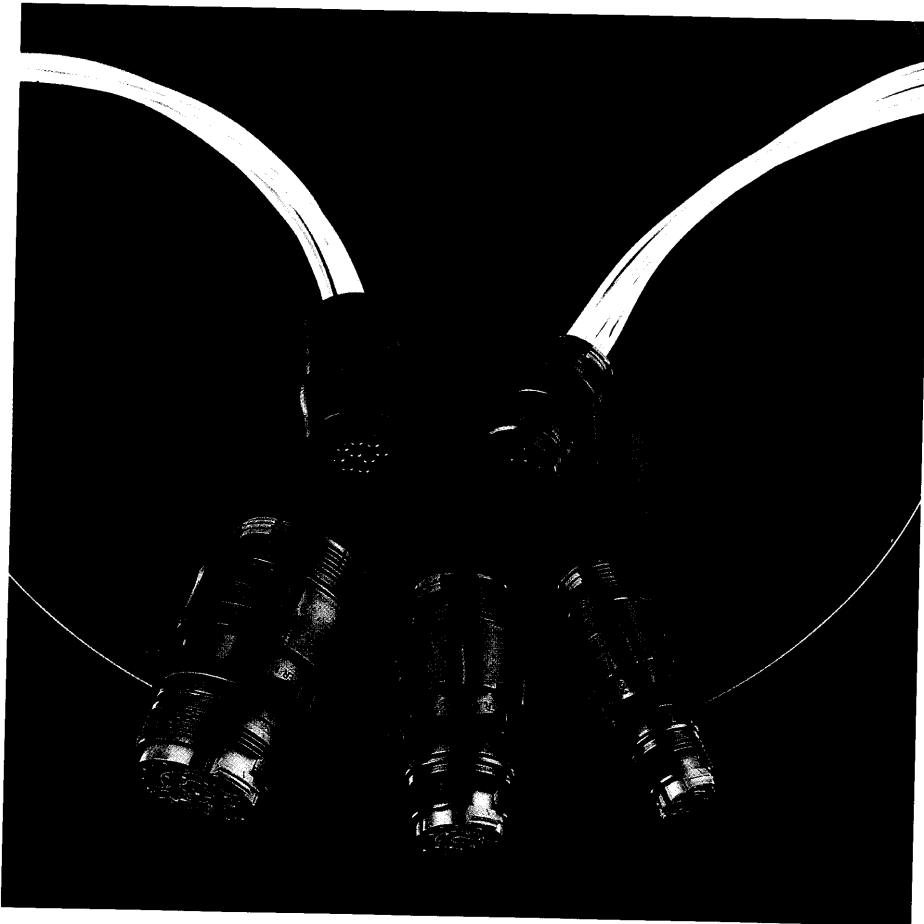

FRAMATOME CONNECTORS
INTERNATIONAL



Framatome Connectors International (FCI) is one of the world's leading connector companies. Its subsidiaries produce products under the well known names of Burndy, Jupiter, Souriau, Connectral and Daut + Rietz.

FCI employs more than 6,000 people worldwide. It operates 32 manufacturing facilities in Europe, North and South America, Japan and South East Asia.

FCI's global product offering is broader than most of its competitors, offering connectors and connector systems to meet the needs of worldwide markets. FCI occupies a leadership position in the telecommunications, data processing, and industrial markets, in the military, aerospace and marine markets, as well as in the automotive, consumer, electrical transmission and construction markets.

Its expertise in interconnection technologies, its industrial competence, a continuous investment in R&D, together with a coordinated global sales and distribution network, make FCI the first choice as a partner for every type of industry.

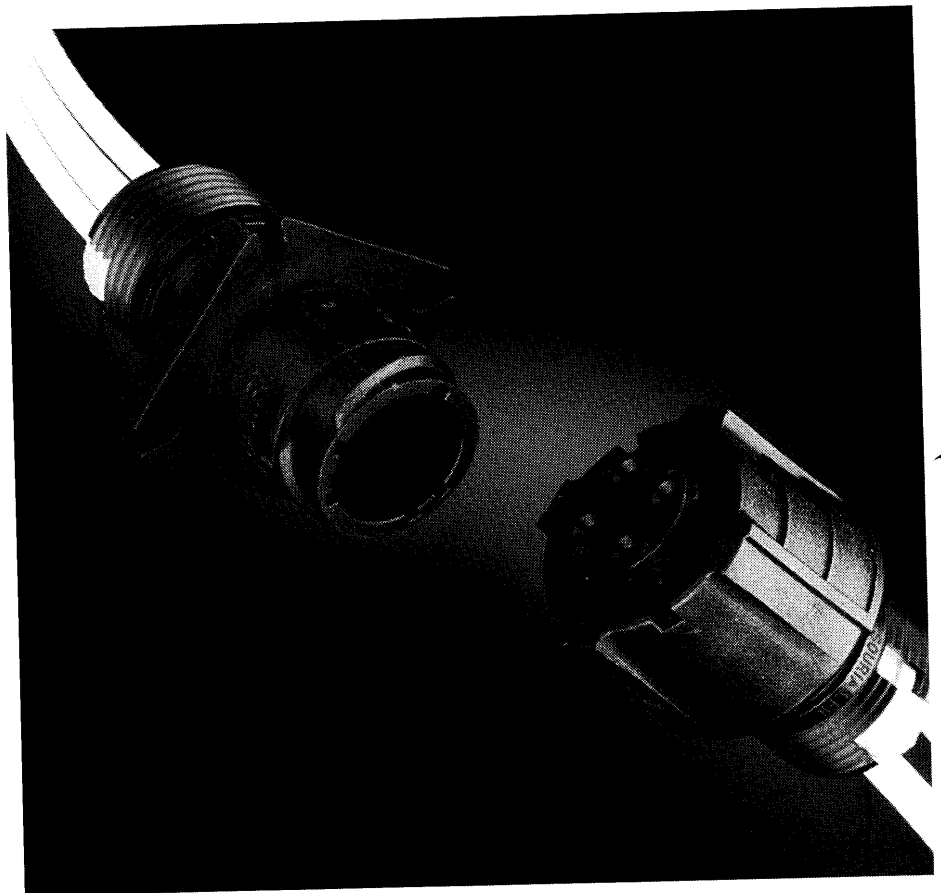

Summary

Presentation	3
Characteristics	4
Styles available	5
Square flange receptacle and in-line receptacle without contacts	6
Plug without contacts and backnut	7
Adaptor and electrical thread backshells	8
Accessories	9
Stamped and formed contacts	10
Machined contacts	11
Plug / receptacle dimensions	12
Mated and unmated connectors with backshells	13
Panel cut-out / Panel mounting / Crimping tools.....	14
General technical informations (degree of protection).....	15



Description

Retention plate principle

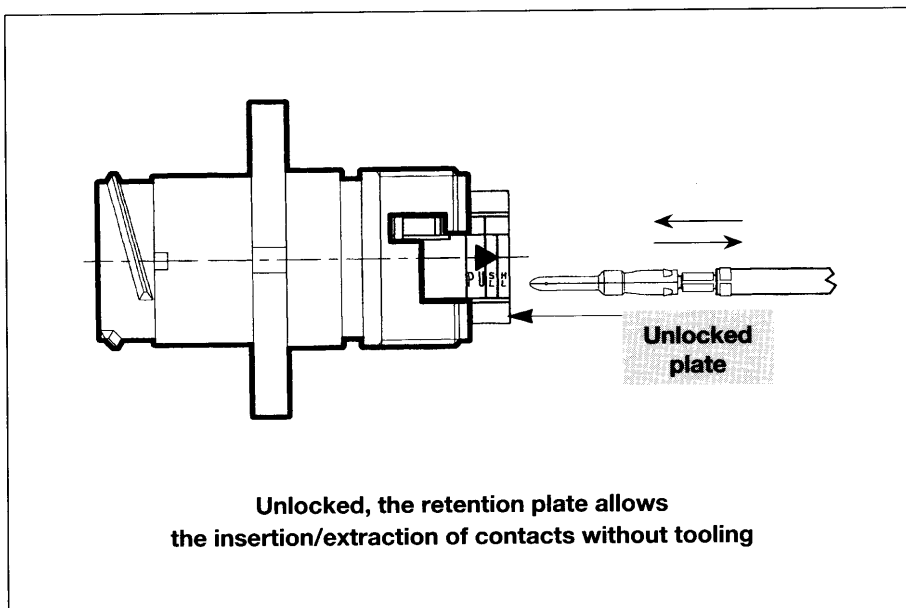
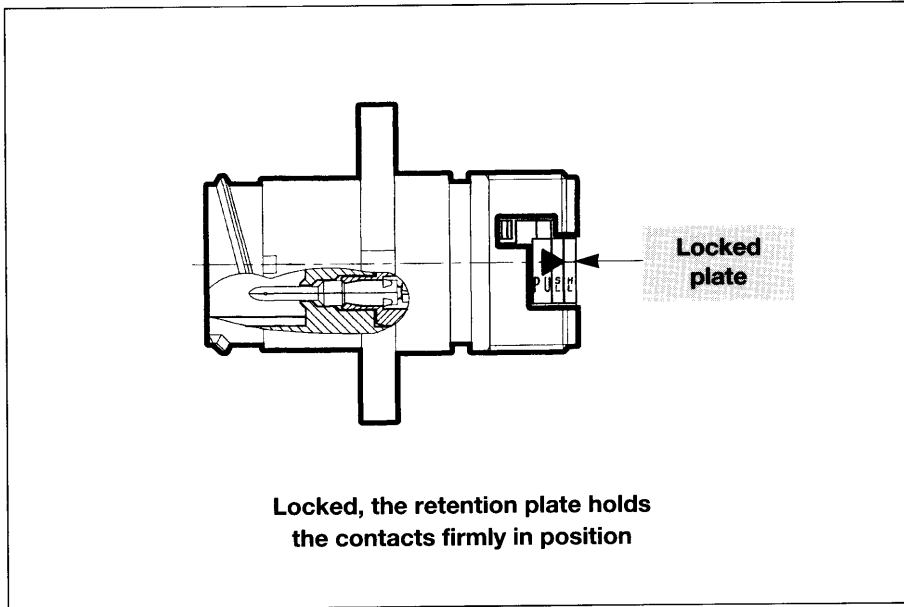

Presentation

CLIPPER is a new plastic low cost range of industrial connectors.

Complementing FCI product range CLIPPER offers :

- a retention plate system allowing insertion/extraction of the contacts without the need for tooling,
- a high sealing level :
 - IP67 for the sealed plug (with o'ring and mating seal)
 - IP68 for the enhanced sealed plug (with o'ring and a special mating seal).

This version allows a permanent waterproof level when immersed at depths down to 30 meters.

- facilities to use trade backshells with the electrical thread adaptor (PG).

CLIPPER range is composed of :

- 4 sizes of shell in moulded black thermoplastic material (size 1/2/3/4).
- 7 contact layouts (4/9/14/18/26/31/40 contacts).
- \varnothing 1 mm \varnothing - 1.6 mm contacts, machined or stamped and formed, crimp or solder.
- An adaptor with electrical thread for PG backshells.
- Backnut with grommet facilities.



Characteristics

Mechanical

- Monobloc shell and insulator in thermoplastic* material self-extinguishing to UL 94 V0.
- 180° screw coupling with positive audible safety latch.
- Scoop proof.
- Copper alloy contacts, machined or stamped and formed :
 - plating : gold flash on active part.
- Mechanical endurance :
 - connector : 250 cycles mating / unmating,
 - retention plate : 50 cycles mating / unmating.
- Retention force :
 - Ø 1 mm = 70 N
 - Ø 1.6 mm = 90 N.
- Vibration :
 - frequency range : 10-2000 Hz, 20 g
 - 10 cycles in accordance with CEI 68-2-6

Electrical

- Withstand voltage : 1500 Vrms min or in accordance with DIN 57110b.
- Contact resistance < 10 mΩ.
- Current rating per contact :
 - machined contacts :
Ø 1 mm (7 A), Ø 1.6 mm (13 A)
 - stamped and formed contacts :
Ø 1 mm (5 A), Ø 1.6 mm (10 A).

Environmental

- Working temperature :
 - 40°C to +125°C.
- Sealing.
Examples :
 - connector + sealing gland : IP68,
 - connector + grommet : IP67.
- Resistance to salt spray :
 - 48 h min
 - > 1000 h (sealed mated connectors).
- Resistance to fluids :
 - oil,
 - petrol, fuel,
 - lubricants
 - other fluids : consult FCI.

* Composite version are under development. Consult FCI.





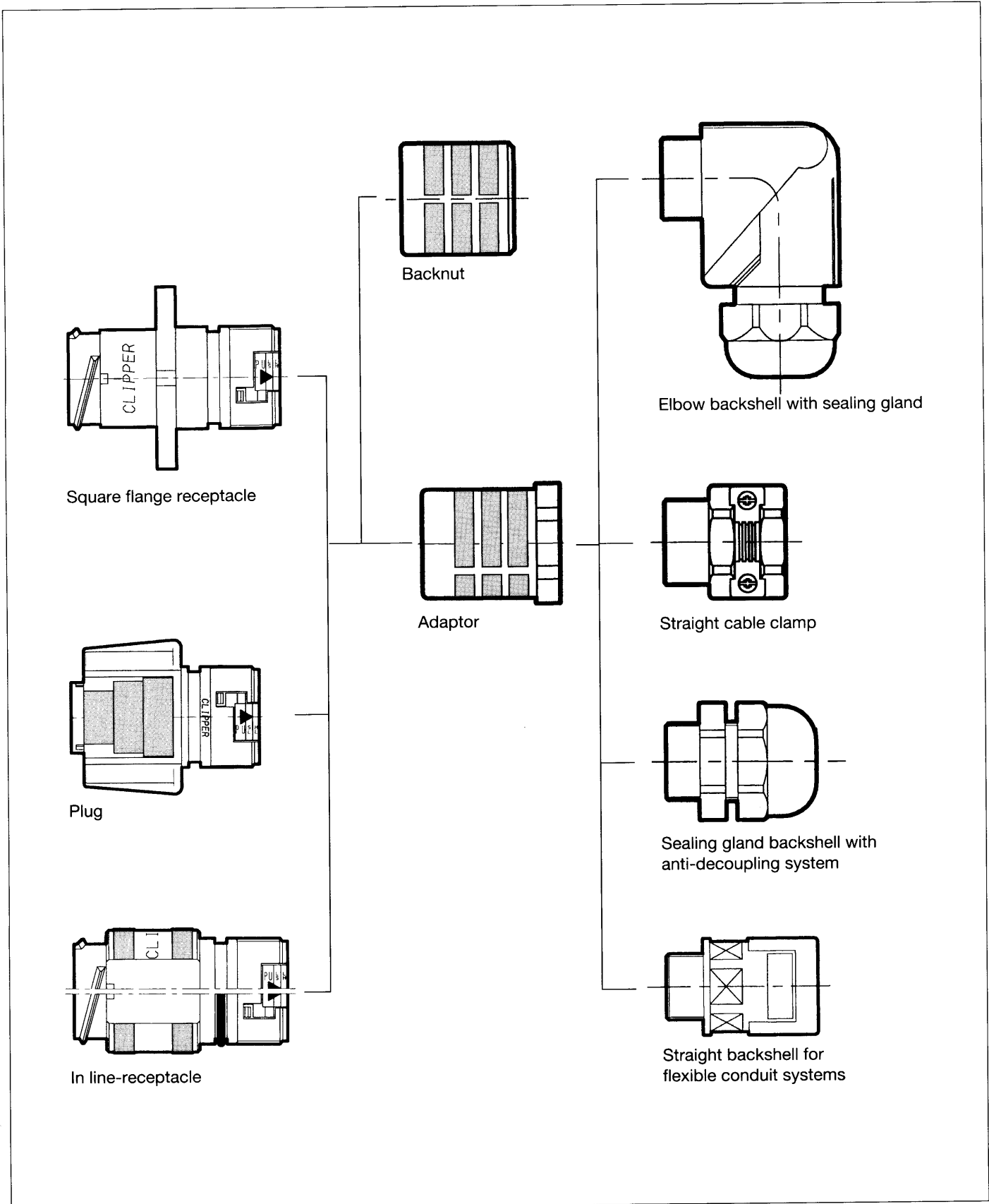



Styles available



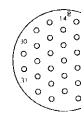

Square flange receptacle and in-line receptacle

Receptacle types without contacts		Part numbers								
		Unsealed receptacle (without o'ring)		Sealed receptacle (with o'ring) for use with backshell		Sealed receptacle (with o'ring and panel gasket)		In-line receptacle		
		for male contacts	for female contacts	for male contacts	for female contacts	for male contacts	for female contacts	unsealed for male contacts	sealed for male contacts	
Shell sizes	1	4 cts Ø 1.6 mm  Class 2 - VDE 380 V	CL1M1100	CL1R1100	CL1M1101	CL1R1101	CL1M1102	CL1R1102	CL1C1100	CL1C1101
		9 cts Ø 1 mm 	CL1M1200		CL1M1201		CL1M1202		CL1C1200	CL1C1201
	2	9 cts Ø 1.6 mm  Class 2 - VDE 250 V	CL1M2100	CL1R2100	CL1M2101	CL1R2101	CL1M2102	CL1R2102	CL1C2100	CL1C2101
		14 cts Ø 1 mm 	CL1M2200		CL1M2201		CL1M2202		CL1C2200	CL1C2201
	3	18 cts Ø 1.6 mm  Class 2 - VDE 250 V	CL1M3100	CL1R3100	CL1M3101	CL1R3101	CL1M3102	CL1R3102	CL1C3100	CL1C3101
		31 cts Ø 1 mm 	CL1M3200		CL1M3201		CL1M3202		CL1C3200	CL1C3201
	4	26 cts Ø 1.6 mm  Class 2 - VDE 250 V	CL1M4100		CL1M4101		CL1M4102		CL1C4100	CL1C4101
		40 cts Ø 1.6 mm 	CL1M4200	CL1R4200	CL1M4201	CL1R4201	CL1M4202	CL1R4202	CL1C4200	CL1C4201



Plug and backnut

Plug types without contacts		Part numbers								
		Unsealed plug (without o'ring and mating seal)		Sealed plug (with o'ring and mating seal)		Backnut sealed		Backnut unsealed		
		for male contacts	for female contacts	for male contacts	for female contacts	for male contacts	for female contacts	for male and female contacts		
Shell sizes	1	4 cts Ø 1.6 mm Class 2 - VDE 380 V	CL1P1100	CL1F1100	CL1P1101	CL1F1101 (IP67) CL1F1103 (IP68)	CL111102	CL111101	CL111000	
		9 cts Ø 1 mm		CL1F1200		CL1F1201 (IP67) CL1F1203 (IP68)	CL111202	CL111201		
	2	9 cts Ø 1.6 mm Class 2 - VDE 250 V	CL1P2100	CL1F2100	CL1P2101	CL1F2101 (IP67) CL1F2103 (IP68)	CL112102	CL112101	CL112000	
		14 cts Ø 1 mm		CL1F2200		CL1F2201 (IP67) CL1F2203 (IP68)				
	3	18 cts Ø 1.6 mm Class 2 - VDE 250 V	CL1P3100	CL1F3100	CL1P3101	CL1F3101 (IP67) CL1F3103 (IP68)	CL113102	CL113101	CL113000	
		31 cts Ø 1 mm		CL1F3200		CL1F3201 (IP67) CL1F3203 (IP68)				
	4	26 cts Ø 1.6 mm Class 2 - VDE 380 V		CL1F4100		CL1F4101 (IP67) CL1F4103 (IP68)	CL114102	CL114101	CL114000	
		40 cts Ø 1.6 mm	CL1P4200	CL1F4200	CL1P4201	CL1F4201 (IP67) CL1F4203 (IP68)	CL114202	CL114201		



Adaptor and electrical thread backshells (PG)

Unsealed

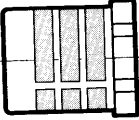
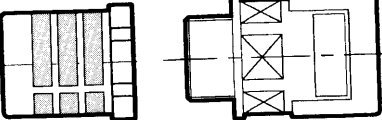
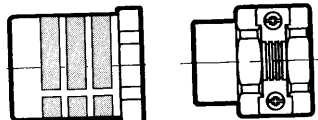
Type	Description	Part numbers				
		Shell sizes				
		1 (PG 13.5)	2 (PG 16)	3 (PG 21)	4 (PG 29)	4 (PG 36)
	Adaptor	CL101000	CL102000	CL103000	CL124000	CL104000
	Straight backshell for flexible conduit systems	CL101040	CL102040	CL103040	CL124040	CL104040
	Straight cable clamp	CL101030	CL102030	CL103030	CL124030	-

Sealed

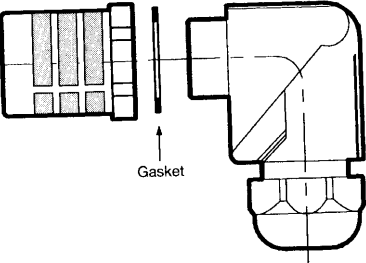
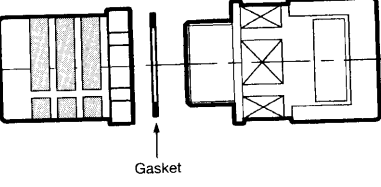
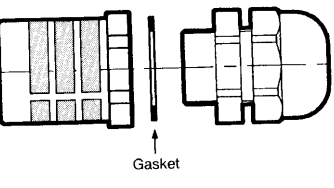
	Elbow backshell with sealing gland IP67	CL101051	CL102051	CL103051	CL124051	-
	Straight backshell for flexible conduit systems IP67	CL101041	CL102041	CL103041	CL124041	CL104041
	Anti-decoupling sealing gland backshell IP68	CL101021	CL102021	CL103021	CL124021	CL104021

Note : Electrical thread backshells are always supplied complete with the adaptor.

Accessories

Panel gasket (for square flange receptacle)

Shell sizes	1	2	3	4
Part numbers	CL191001	CL192001	CL193001	CL194001

Elbow adaptors for receptacles

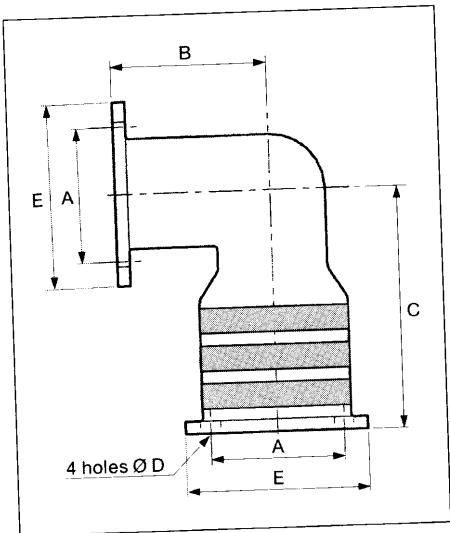

Dim. (mm)	Shell sizes				
	A	B	C	D	E
1	21.4	24.5	38.7	3.2	29.2
2	24.6	28.0	39.7	3.2	30.8
3	28.5	30.5	42.8	3.8	35.6
4	36.5	39.4	49.5	3.8	47.5

Elbow adaptors for receptacles Shell 1 to 4

Shell	Part numbers	
	Sealed	Unsealed
1	CL131001	CL131000
2	CL132001	CL132000
3	CL133001	CL133000
4	CL134001	CL134000

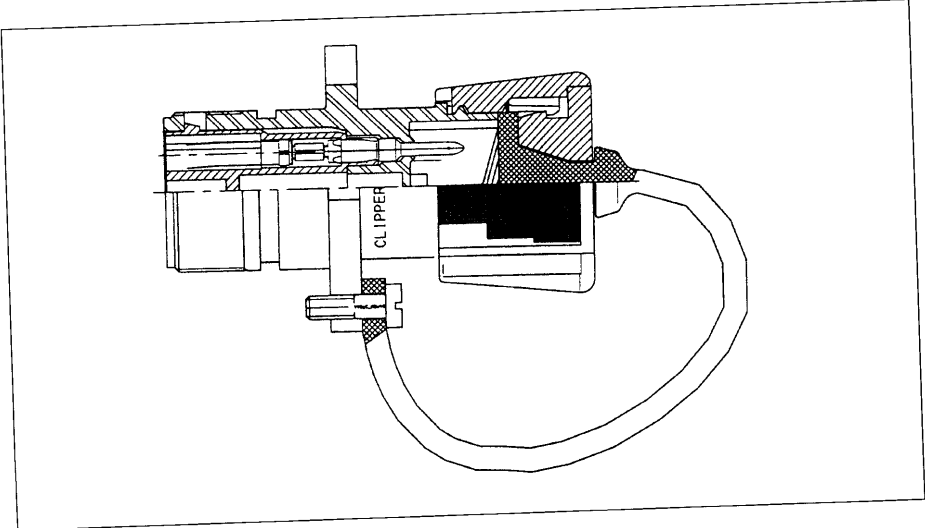

Dust cap for receptacle IP67



Shell	Part numbers
1	CL141001
2	CL142001
3	CL143001
4	CL144001

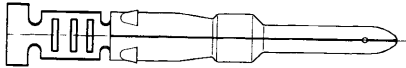
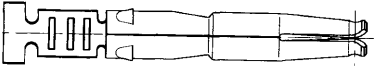
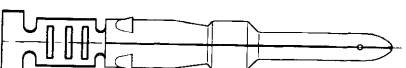
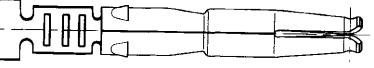
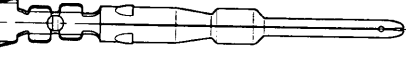

Stamped and formed contacts

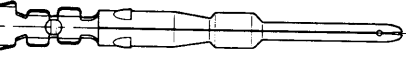
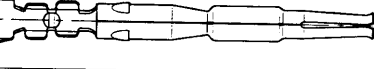
Packaging	Contact types with insulation support		∅ (mm)	Wire insul. diameter ∅ (mm)	Cable acceptance (mm ²)	Part numbers
Bulk		male	1.6	2.00 min.	0.70 to 1.50	CF16PC10RF
		female		3.00 Max.		CF16SC10RF
Reel 5000 pieces		male	1.6	2.00 min.	0.70 to 1.50	CF16PC19RF
		female		3.00 Max.		CF16SC19RF
Bulk		male	1	1.20 min.	0.35 to 0.60	CF10PC10RF
		female		2.10 Max.		CF10SC10RF
Reel 5000 pieces		male	1	1.20 min.	0.35 to 0.60	CF10PC19RF
		female		2.10 Max.		CF10SC19RF

Plating RF : gold flash on active part for standard version.

Filler plug ∅ 1.6 mm
(for un-used contact cavities)

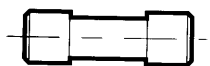



Part number : 8500 479 CL

For other platings, consult FCI.

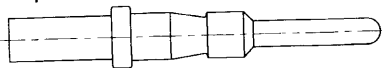
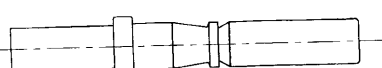
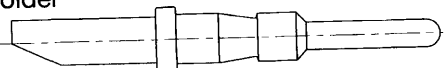
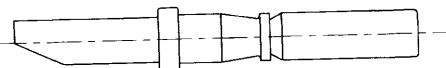
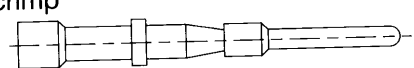
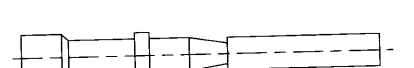

Machined contacts

Packaging	Contact types	Ø (mm)	Wire insul. diameter Ø (mm)	Cable acceptance (mm ²)	Part numbers	
Bulk	crimp 	male	1.6	2.00 min.	0.93 to 1.91	CM16PC10MQ
				0.6 *	CM16PC20MQ	
		female		3.00 Max.	0.93 to 1.91	CM16SC10MQ
				0.6 *	CM16SC20MQ	
Bulk	solder 	male	2.00 min.	1.91 Max.	CM16PS10MQ	
				female	3.00 Max.	1.91 Max.
Bulk	crimp 	male			1	1.20 min.
			0.06 to 0.21*	CM10PC20MQ		
		female	2.10 Max.	0.21 to 0.93		CM10SC10MQ
			0.06 to 0.21*	CM10SC20MQ		
Bulk	solder 	male	1.20 min.	0.93 Max.	CM10PS10MQ	
				female	2.10 Max.	0.93 Max.

* Delivered with reducing sleeve

Plating MQ : 0.4 µ min gold on active part for standard version

Extended ground contact-crimp (+ 1 mm)

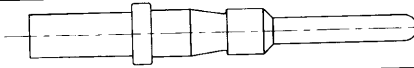
Bulk		male	1.6	2.00 min. 3.00 Max.	0.93 to 1.91	8501 9641
------	---	------	-----	------------------------	--------------	------------------

Filler plug Ø 1.6 mm
(for un-used contact cavities)



Part number : 8500 479 CL

For other platings, consult FCI.



Dimensions

Square flange receptacle

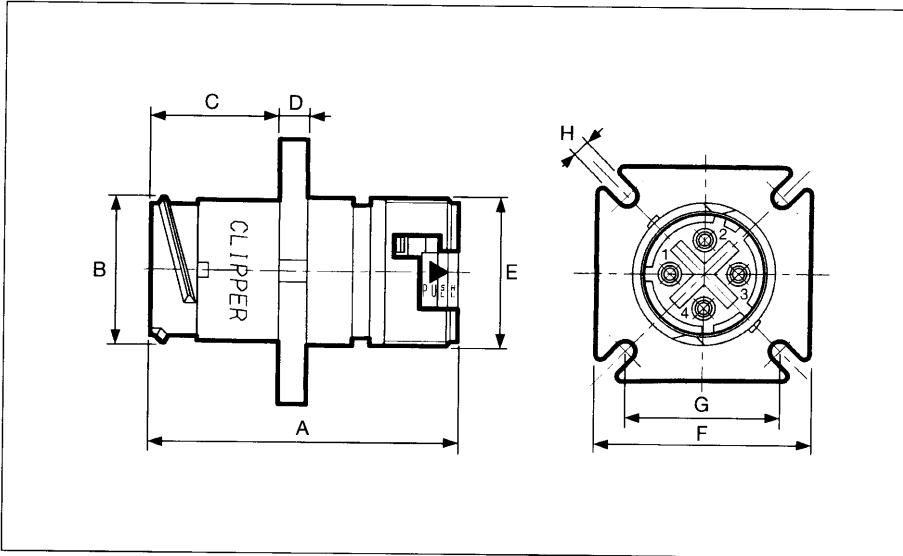

Dim. (mm)	Shell sizes	Shell sizes			
		1	2	3	4
A		42.4	42.4	42.4	42.4
B		21.0	24.5	29.0	40.5
C		18.0	18.0	18.0	18.0
D		4.0	4.0	4.0	4.0
E		20.5	24.0	28.5	40.0
F		29.7	31.3	36.0	47.9
G	min.	21.1	24.3	28.3	36.2
	Max.	23.3	24.9	29.7	40.0
H		3.2	3.2	3.8	3.8

Plug

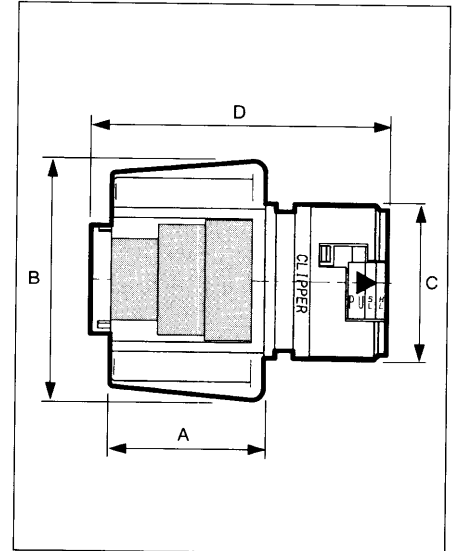

Dim. (mm)	Shell sizes	Shell sizes			
		1	2	3	4
A		20.20	20.20	20.20	20.20
B		29.10	32.50	37.10	48.80
C		20.50	24.00	28.50	40.00
D		38.60	39.60	39.60	39.60



Mated and unmated connectors with backshells

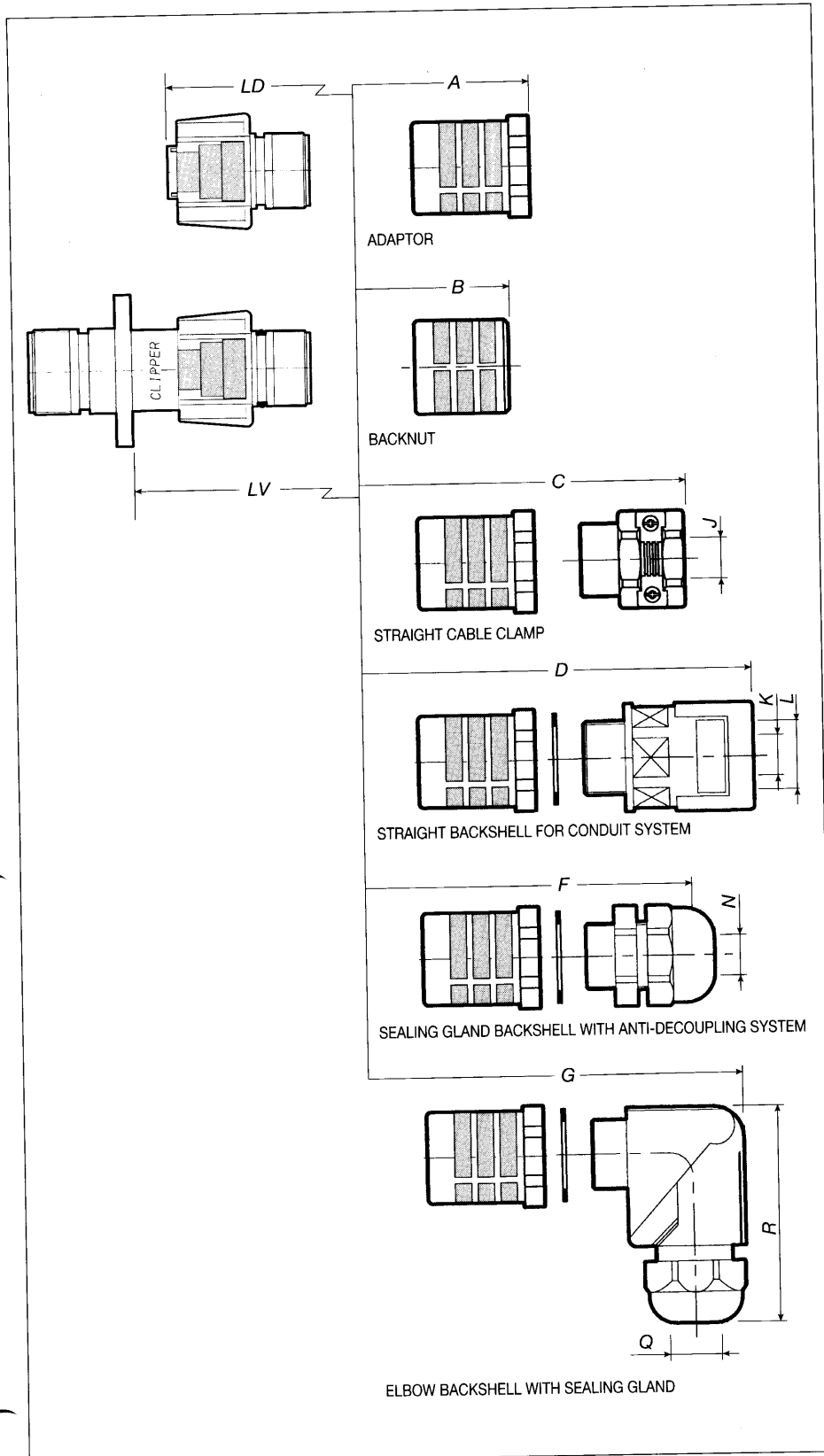

dimensions

Shell Dim. (mm)	1	2	3	4	
				(PG 29)	(PG 36)
LDA	51	53.2	53.2	55.2	55.2
LVA	58.2	59.2	59.2	61.2	61.2
LDB	46	47	47	-	47
LVB	53	53	53	-	53
LDC	68	72.5	77	86.5	-
LVC	75.5	78.5	83	91.5	-
LDD	86.5	89	92	94	108
LVD	94	95	98	100	113.5
LDF	80	83	85	95	102
LVF	87	89	91	101	108
LDG	84	88	96	109	-
LVG	91	94	102	115	-
R Max.	57	59.5	73	91	-

cable acceptance *

Shell Dim. (mm)	1	2	3	4	
				(PG 29)	(PG 36)
J	6/14	6/16	8/21	10/28	
Conduit L Pmaxflex	17	17	23	29	36
K Max.	16	16	21,5	27,5	36
N	6/12	10/14	13/18	18/25	22/32
Q	6/12	10/14	13/18	18/25	-

* For other needs, consult FCI.



Panel cut-out

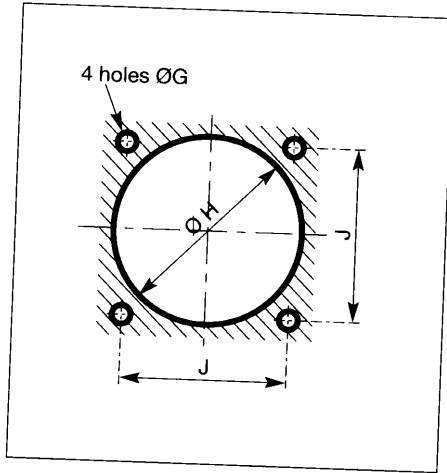

Shell sizes Dim. (mm)	1	2	3	4
H	21.5	25	31	41
J	21.4	24.6	28.6	36.5
G	3.2	3.2	3.8	3.8

Panel mounting

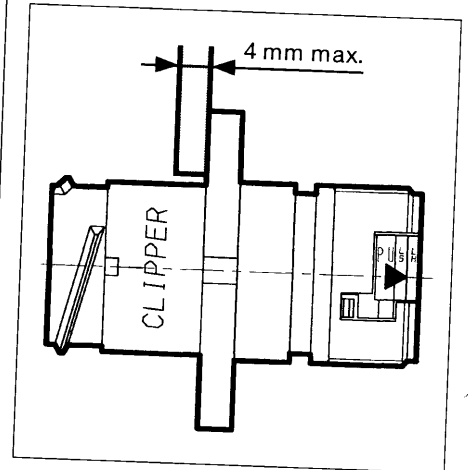

Interchangeability with MIL-C-5015

CLIPPER	MIL-C-5015
Shell 1	Shell 14
Shell 2	Shell 16
Shell 3	Shell 20
Shell 4	Shell 28

Crimping tools *

Machined contacts
(\varnothing 1 mm - \varnothing 1.6 mm)

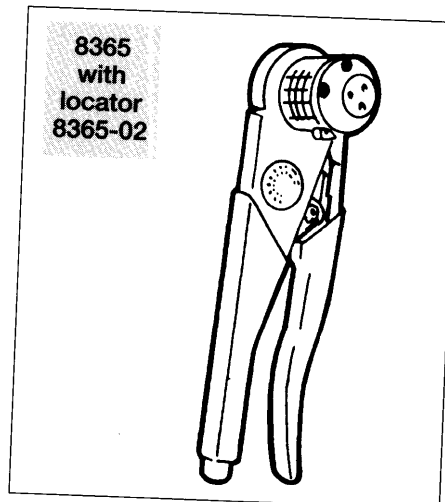
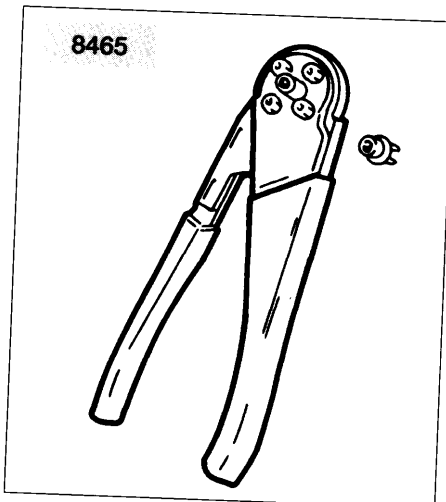

Stamped and formed contacts
(\varnothing 1 mm - \varnothing 1.6 mm)

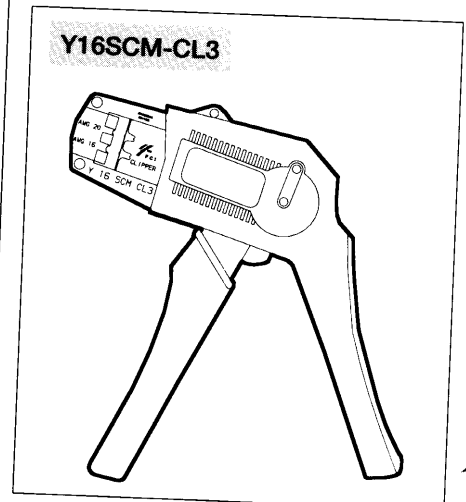

* Other manual or semi-automatrical crimping tool available, consult FCI. See wiring instructions.



General technical informations

Degree of protection in accordance with CEI 529, DIN 40050, NF EN 60529

First index Protection against accidental or inadvertent contact. Prot. against ingress of foreign bodies.		Second index Protection against ingress of water		Third index Protection against mechanical strength	
Index	Test	0	No protection	0	No protection
0	IP00 No protection	IPx0		Troisième chiffre	Test
1	IP11 Ball Ø 50 mm Protection against contact with any large area by hand, protect. against large solid foreign bodies with Ø > 50 mm.	1	Protection against vertical drop water drips.	1	Impact strength : 0,225 J
2	IP22 Ball Ø 12.5 mm Test finger Protection against contact with the fingers, prot. against solid foreign bodies with Ø > 12.5 mm.	IPx1		IPx2	± 15°
3	IP33 Steel wire Ø 2.5 mm Protection against tools wires or similar objects with Ø > 2.5 mm, prot. against small foreign solid bodies with Ø > 2.5 mm.	3	Protection against diagonal drop water drips (up to < of 60° out of vertical)	4	Protection against splash water from all directions
4	IP44 Steel wire Ø 1 mm Protection against tools wires or similar objects with Ø > 1 mm, prot. against small foreign solid bodies with Ø > 1 mm.	5	Protection against water (out of a nozzle) from all directions	5	Impact strength : 0,5 J
5	IP55 Full protection against acid. or inadiv. contact. Prot. against interior injurious dust deposits.	6	Proof against temporary flooding	7	Impact strength : 2 J
6	Total protection against acid. or inadiv. contact. Protection against of dust.	7	Protection against water plunging Proof against temporary water plunging	8	Water tight
		8	Water tight	W	Proof against water pressure
		9		9	Impact strength : 20 J

EXAMPLE : IP66-5 means: - Total protection against dust
- Proof against temporary flooding
- Proof against impact strength of 2 Joule