

Inhaltsverzeichnis / Contents	Type	Seite Page
Allgemeine Erläuterungen / General Notes		3+4
SMD-Sicherungseinsätze / SMD fuse-links		
2,6 mm x 6,1 mm F	70 169 74, 70 170 74	5
2,6 mm x 6,1 mm T	70 169 75, 70 170 75	6
Keinstsicherungen / Sub-miniature fuse-links		
8,4 mm Ø x 7,6 mm IEC127-3-3 F	70 159 72; 70 160 72, 70 161 72	7
8,4 mm Ø x 7,6 mm (IEC127-3) M	70 159 02, 70 160 02, 70 161 02	8
8,4 mm Ø x 7,6 mm IEC127-3-4 T	70 159 73, 70 160 73, 70 161 73	9
8,4 mm Ø x 7,6 mm UL 248-14 F	70 162 71, 70 163 71, 70 164 71	10
8,4 mm Ø x 7,6 mm UL 248-14 T	70 162 76, 70 163 76, 70 164 76	11
Sicherungshalter / fuse-holder	71 158 01	48
G-Sicherungseinsätze / miniature fuse-links		
5 mm Ø x 20 mm DIN VDE 0820 Teil22 Normblatt2 IEC127-2-2 F	70 001 34	12
5 mm Ø x 20 mm DIN VDE 0820 Teil22 Normblatt1 IEC127-2-1 F	70 007 33	13
5 mm Ø x 20 mm DIN 41571 T.1 F	70 004 01	14
5 mm Ø x 20 mm DIN 41571 T.2 M	70 001 02, 70 004 02	15
5 mm Ø x 20 mm DIN 41571 T.2 M	70 007 02	16
5 mm Ø x 20 mm DIN VDE 0820 Teil22 Normblatt3 IEC127-2-3 T	70 001 35	17
5 mm Ø x 20 mm DIN 41571 T.3 T	70 004 03	18
5 mm Ø x 20 mm DIN VDE 0820 Teil22 Normblatt5 IEC127-2-5 T	70 007 65	19
5 mm Ø x 20 mm DIN VDE 0820 Teil 22 A1 (Entwurf), IEC 127-2-6 (draft)	70 001 79	20
5 mm Ø x 20 mm UL 248	70 001 76	21
5 mm Ø x 20 mm FF	70 001 40, 70 007 40	22
6,35 mm Ø x 32 mm DIN VDE 0820 Teil22 Normblatt4 IEC127-2-4 F	70 059 60	23
6,35 mm Ø x 32 mm F (Keramik/ceramic)	70 065 63	24
6,35 mm Ø x 32 mm T	70 059 61	25
6,35 mm Ø x 32 mm T (Keramik/ceramic)	70 065 65	26
6,35 mm Ø x 32 mm UL 248	70 059 76	27
6,35 mm Ø x 32 mm FF	70 125 40	28
12,5 mm Ø x 41 mm DIN 41687 M	10 001 11	29
10 mm Ø x 51 mm DIN 41572	70 019 08	30
5 mm Ø x 25 mm DIN 41576 T.2 M	70 011 05, 70 010 05	31
5 mm Ø x 20 mm + 25 mm DIN 41577 T.2 M	70 014 07, 70 016 07, 70 017 07, 70 012 05	32
5 mm Ø x 25 mm DIN 41576 T.1 F	70 010 04	33
5 mm Ø x 25 mm F	70 089 13	34
5 mm Ø x 25 mm F	70 002 34	34
5 mm Ø x 25 mm M	70 002 02, 70 005 02	35
5 mm Ø x 30 mm F	70 003 34	36
5 mm Ø x 30 mm M	70 003 02, 70 006 02	36
8 mm Ø x 50 mm DIN 41570	70 032 09, 70 034 09	37
8 mm Ø x 85 mm DIN 41569	70 035 09, 70 037 09	38
10 mm Ø x 85 mm	70 115 09	39
8 mm Ø x 120 mm DIN 41683	70 038 10, 70 040 10	40
8 mm Ø x 150 mm DIN 41684	70 041 10, 70 043 10	41
G-Sicherungshalter / fuse-holder		
(5 mm Ø x 20 mm)	71 001 27	42
(5 mm Ø x 20 mm + 6,35 mm Ø x 32 mm)	71 001 14	42
(5 mm Ø x 20 mm)	71 001 28	43
(5 mm Ø x 20 mm + 6,35 mm Ø x 32 mm)	71 001 16	43
(5 mm Ø x 20 mm)	71 001 29	44
(5 mm Ø x 20 mm + 6,35 mm Ø x 32 mm)	71 001 23	44
(5 mm Ø x 20 mm + 6,35 mm Ø x 32 mm)	71 001 24	45
(5 mm Ø x 20 mm + 5 mm Ø x 25 mm)	71 001 10	45
(10 mm Ø x 85 mm)	71 037 02	50
G-Sicherungshalter, offene Bauart / fuse-holder open-type		
(5 mm Ø x 20 mm)	71 001 05	46
(5 mm Ø x 20 mm)	71 001 09	46
(5 mm Ø x 20 mm)	71 001 26	47
Abdeckung für 71 001 26 / cover for 71 001 26	73 002 01	47
(8 mm Ø x 50 mm - 85 mm - 120 mm)	71 034 01, 71 037 01, 71 040 01	49
G-Sicherungshalter / fuse-clips		
5 mm Ø	74 001 02	49
Aufsteckkappen / Push-on caps		
5 mm Ø	73 001 01	48
6,35 mm Ø	73 001 02	48
Art.-Nr. Verzeichnis / part no. index		51

Allgemeine Erläuterungen

Aufgabe

Eine Geräteschutzsicherung (G-Sicherung) ist eine Schaltvorrichtung, die durch Abschmelzen des Schmelzleiters einen Stromkreis unterbricht, wenn der Strom einen bestimmten Wert während einer bestimmten Dauer überschreitet. Die G-Sicherung umfaßt alle Teile, die zu der vollständigen Schaltvorrichtung gehören.

Begriffe

- G-Sicherungsunterteil
(G-Sicherungssockel)

Der fest einzubauende Teil einer G-Sicherung mit den Anschlüssen für die Verbindung zum äußeren Stromkreis.

- G-Sicherungseinsatzträger
(G-Schraub- oder G-Renkkappe)

Der bewegliche Teil der G-Sicherung, der den G-Sicherungseinsatz aufnimmt und dessen Auswechseln ermöglicht.

- G-Sicherungshalter

Die Kombination aus G-Sicherungsunterteil und zugehörigem G-Sicherungseinsatzträger.

- G-Sicherungseinsatz

Der Teil der Sicherung, der den Schmelzleiter enthält, und der nach dem Ansprechen der G-Sicherung durch einen neuen ersetzt werden muß.

G-Sicherungseinsätze müssen so gebaut sein, daß ihre Funktion zuverlässig und sicher ist, und daß ihre Eigenschaften bei jedem Strom bis zum Bemessungsausschaltvermögen und bei jeder Spannung bis zur Bemessungsspannung erhalten bleiben.

- Schmelzleiter

Der Teil des G-Sicherungseinsatzes, dessen Abschmelzen den Ausschaltvorgang bewirkt.

Auswahlkriterien für G-Sicherungseinsätze

- Bemessungsspannung

Die Bemessungsspannung muß gleich oder größer sein als die Betriebsspannung des zu schützenden Gerätes.

- Bemessungsstrom

Der Bemessungsstrom des G-Sicherungseinsatzes soll etwa dem Betriebsstrom des zu schützenden Gerätes entsprechen, im Normalbetrieb soll der Bemessungsstrom nicht überschritten werden. Bei erhöhten Einschaltströmen empfiehlt sich die Verwendung mittelträger und träger G-Sicherungseinsätze.

- Bemessungsausschaltvermögen

Das Bemessungsausschaltvermögen kennzeichnet den Strom bei Nennspannung, der ordnungsgemäß abgeschaltet werden muß, ohne daß der G-Sicherungseinsatz zerstört wird oder ein Lichtbogen stehen bleibt. Es ist folglich zu beachten, daß auch im Kurzschlußfall kein größerer Strom fließen darf, als es dem Bemessungsausschaltvermögen des G-Sicherungseinsatzes entspricht.

- Spannungsfall

Der Spannungsfall der G-Sicherungseinsätze (bei Bemessungsstrom) darf die in den Standards angegebenen Maximalwerte nicht übersteigen.

General Notes

Function

A fuse is a switching device that opens the circuit in which it is fitted by melting of the element when the current exceeds a given value for sufficient time. A fuse consists of all the parts that form this complete switching device.

Definitions

- Fuse-base
(Fuse-mount)

The fixed part of the device fitted with connectors to link with the external circuit.

- Fuse-carrier

The movable part of the device which carries the fuse-link.

- Fuse-holder

Combination of fuse-mount and fuse-carrier.

- Fuse-link

The part of the fuse which includes the fuse-element and requires replacement after operation. Fuse-links shall be constructed so that they are reliable and safe in operation with consistent performance at any current up to and including the breaking capacity rating and any voltage up to the rated voltage.

- Fuse-element

That part of a fuse-link designed to melt when the fuse operates.

Criteria used when selecting Fuses

- Rated Voltage

The rated voltage must be equal to or higher than the working voltage expected.

- Rated Current

The rated current should correspond to the approximate working current of the apparatus being protected, in normal operation this current should not be exceeded. In circuits where peaks are expected, medium time-lag or time-lag fuses should be used.

- Rated Breaking Capacity

The rated breaking capacity is the stated current switching capacity of the device at the stated voltage which, when operation takes place, will not damage the fuse set nor allow arcing. It is therefore important to take care that under short circuit conditions the current available should not exceed the rated breaking capacity of the device.

- Voltage Drop

The voltage drop of the fuse set at a given current may not exceed the maximum figure shown in the standard.

- Superflinke G-Sicherungseinsätze (FF)

werden als Kurzschlußschutz für Halbleiterbauelemente (Thyristoren, Dioden, Triacs) verwendet.

- Flinke G-Sicherungseinsätze (F)

schützen Geräte und Baugruppen gegen hohe Über- und Kurzschlußströme, sie werden in Stromkreisen ohne Einschaltstromstöße oder auch als Netzsicherungen eingesetzt.

- Mittelträge G-Sicherungseinsätze (M)

werden vornehmlich bei kleineren Betriebsspannungen benutzt, wenn keine großen Einschaltströme zu berücksichtigen sind.

- Träge G-Sicherungseinsätze (T)

finden Verwendung, wenn hohe und nur langsam abklingende Einschaltströme auftreten.

Normen

Für Geräteschutzsicherungen gelten im wesentlichen die folgenden internationalen und nationalen Normen:

IEC 60 127

EN 60 127

IEC 60 257

CEE 4

DIN VDE 0820, Teil 1

DIN VDE 0820, Teil 2

DIN VDE 0820, Teil 3

UL 248-14

UL 512

CSA Standard C 22.2 No. 248.14

Hinweis

Bei Verwendung der mit * gekennzeichneten G-Sicherungseinsätzen ist auf ausreichende Wärmeabfuhr zu achten.

Zusätzlich sind die üblicherweise höheren Verlustleistungen von Ultra Rapid Sicherungseinsätzen (FF) zu beachten.

- Very quick-acting Fuse-links (FF)

are used for short circuit protection of semiconductor components (thyristors, diodes, triacs).

- Quick-acting Fuse-links (F)

Protect equipments and circuits against high or shortcircuit currents. They are used when no surges are anticipated or as mains fuses.

- Medium time-lag Fuse-links (M)

Used mainly when only small voltages and switching currents have to be taken into consideration.

- Time-lag Fuse-links (T)

For applications where high, slowly decreasing switching currents are expected.

Standards

The following important international and national standards apply:

IEC 60 127

EN 60 127

IEC 60 257

CEE 4

DIN VDE 0820, Part 1

DIN VDE 0820, Part 2

DIN VDE 0820, Teil 3

UL 248-14

UL 512

CSA Standard C 22.2 No. 248.14

Notice

When using the fuse-links marked with *, sufficient heat dissipation should be considered.

In addition please consider the higher power losses of Ultra-rapid fuse links (FF).

SMD - Sicherungseinsätze

SMD - fuse-links

Keramikgehäuse, undurchsichtig
Ceramic tube, non-transparent

Kontaktkappen Cu-Legierung, versilbert
Contact caps copper alloy, silver plated

Lötwärmebeständigkeit: IEC 60068 260°C, 10 s
Soldering heat resistance:

F

flink
quick acting

empfohlene Anschlußflächen
recommended pad layout

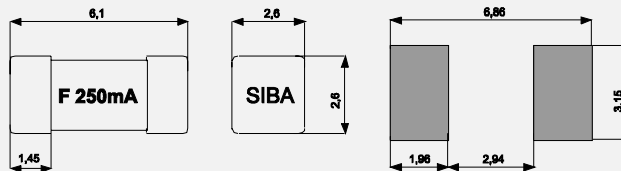

Art.-Nr.	Bemessungsstrom rated current	Spannungsabfall voltage drop mV max.	Schmelzintegral I ² t-value A ² s	Bemessungs- ausschaltvermögen rated breaking capacity	Bemessungs- spannung rated voltage	Approbationen Approvals
	0,062	1.100	0,0009			
	0,125	700	0,01			
	0,25	400	0,02			
	0,375	300	0,056			
	0,5	250	0,11			
	0,75	230	0,32			
	1	200	0,16			
70 169 74¹⁾	1,5	200	0,39	50 A bei / at 125 V AC/DC	125 V	
70 170 74²⁾	2	180	0,57			
	2,5	180	1,1			
	3	180	1,5			
	3,5	180	2			
	4	160	3,3			
	5	150	5,1			
	7	140	11			
	10	140	24	50 A 65 V AC/DC	65 V	
	12	140	41			
	15	140	81			

1) lose / bulk

2) im Blistergurt / on Blister tape (EIA-Norm/EIA-Standard)

Grenzwerte der Schmelzzeit / pre-arcing time limits

Bemessungs- strom rated current	1,0 x I _{rat}	2,0 x I _{rat}	10 x I _{rat}
≤ 10 A	> 4 h	< 5 s	1ms - 10 ms
≥ 12 A	> 4 h	< 20 s	1ms - 10 ms

Gewicht / weight: 0,015 kg/100

Verpackungseinheit / packing unit:
100 Stück/pcs. lose / bulk
1000 Stück im Blistergurt / on Blister tape

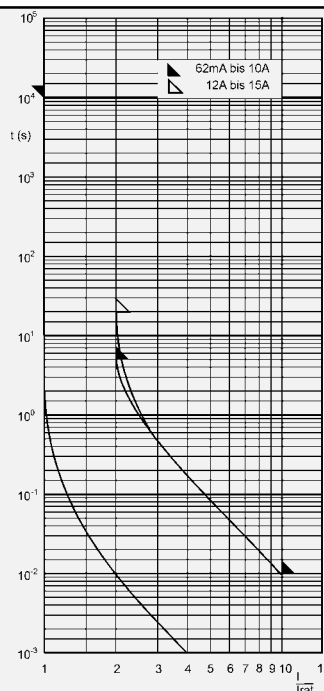

SMD - Sicherungseinsätze

SMD - fuse-links

Keramikgehäuse, undurchsichtig
Ceramic tube, non-transparent

Kontaktkappen Cu-Legierung, versilbert
Contact caps copper alloy, silver plated

Lötwärmebeständigkeit: IEC 60068 260°C, 10 s
Soldering heat resistance:



träge
time-lag

empfohlene Anschlußflächen
recommended pad layout

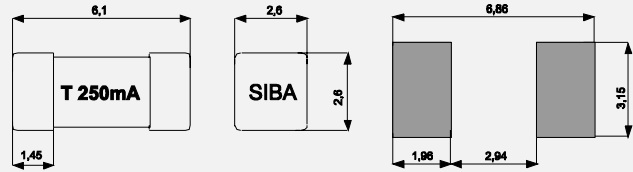

Art.-Nr.	Bemessungsstrom rated current	Spannungsabfall voltage drop mV max.	Schmelzintegral I ² t-value A ² s	Bemessungs- ausschaltvermögen rated breaking capacity	Bemessungs- spannung rated voltage	Approbationen Approvals
	0,25	600	0,08			
	0,315	600	0,16			
	0,375	500	0,3			
	0,4	500	0,32			
	0,5	500	0,7			
	0,63	500	0,8			
	0,75	400	1,2			
	0,8	400	1,4			
	1	300	2,5			
70 169 75¹⁾	1,25	300	4,0	50 A bei / at 125 V AC / DC	125 V	
70 170 75²⁾	1,5	300	4,5			
	1,6	300	5,0			
	2	300	8,0			
	2,5	250	15			
	3	250	22			
	3,15	250	23			
	3,5	200	30			
	4	200	40			
	5	200	60			
	6,3	200	130			

1) lose / bulk

2) im Blistergurt / on Blister tape (EIA-Norm/EIA-Standard)

Grenzwerte der Schmelzeit / pre-arcing time limits

Bemessungs- strom rated current	1,0 x I _{rat}	2,0 x I _{rat}	10 x I _{rat}
0,25 A - 6,3 A	> 4 h	< 60 s	10 ms ... 100 ms

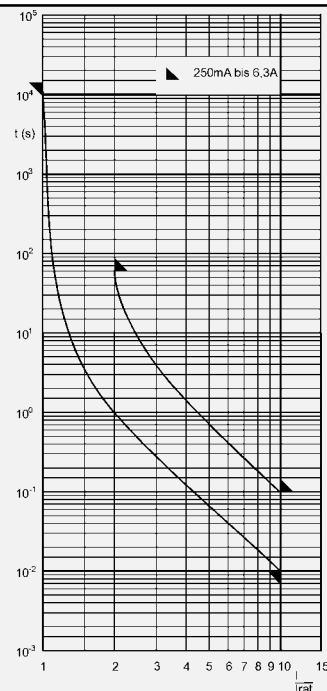

Gewicht / weight: 0,015 kg/100

Verpackungseinheit / packing unit:
100 Stück/pcs. lose / bulk
3000 Stück im Blistergurt / on Blister tape

Kleinstsicherungen mit radialen Anschlußdrähten
Sub-miniature fuse-links with radial terminations

DIN VDE 0820 Teil 3 Normblatt 3
IEC 60127-3/3
EN 60 127-3/3

Approbationen / approvals

Thermoplast, schwarz
temperaturbeständig
selbstverlöschend
Thermoplastic, black
temperature resistant
self-extinguishing

F flink
quick-acting



Anschlußstifte 0,6 mm ø, verzinkt
löt- oder steckbar
Terminations 0,6 mm ø, tinned
solderable or pluggable

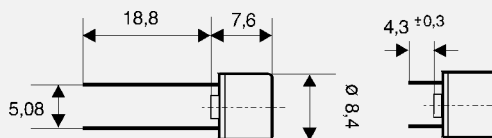

ELU Type
164 000
164 050

Art.-Nr.	Bemessungsstrom rated current	Spannungsabfall voltage drop mV max.	Schmelzintegral I ² t-value A ² s	Verlustleistung Power loss bei/at 1,5 x I _{rat} mW	Bemessungs- ausschaltvermögen rated breaking capacity	Bemessungs- spannung rated voltage	Approbationen Approvals SEMKO
	50 mA	850	0,0003	95			•
	63 mA	750	0,0007	110			•
	80 mA	650	0,0015	120			•
	100 mA	600	0,0035	155			•
	125 mA	550	0,006	175			•
	160 mA	500	0,011	210			•
	200 mA	480	0,018	80			•
	250 mA	440	0,036	90			•
	315 mA	400	0,05	120			•
70 159 72¹⁾	400 mA	370	0,1	140	L _I 35 A	250 V	•
70 160 72²⁾	500 mA	350	0,18	160	bei / at		•
70 161 72³⁾	630 mA	320	0,33	180	250 V 50 Hz		•
	800 mA	300	0,14	200	COS φ = 1,0		•
	1 A	280	0,24	220			•
	1,25 A	280	0,35	260			•
	1,6 A	250	0,60	280			•
	2 A	240	1,2	340			•
	2,5 A	200	2,0	420			•
	3,15 A	180	3,5	580			•
	4 A	160	6,2	700			•
	5 A	150	13,0	900			•

1) kurze Stifte / short pins (4,3^{±0,3} mm)
2) lange Stifte / long pins (18,8^{±0,3} mm)
3) gegurtet / on tape

Grenzwerte der Schmelzzeit / pre-arcing time limits

Bemessungsstrom rated current	1,5 I _{rat}	2,1 I _{rat}	2,75 I _{rat}	4 I _{rat}	10 I _{rat}
50 mA - 5 A	> 1 h	< 30 min.	10 ms ... 3 s	3 ms ... 300 ms	< 20 ms

Gewicht / weight: 0,1 kg/100

Verpackungseinheit / packing unit: 100 Stück/pcs.

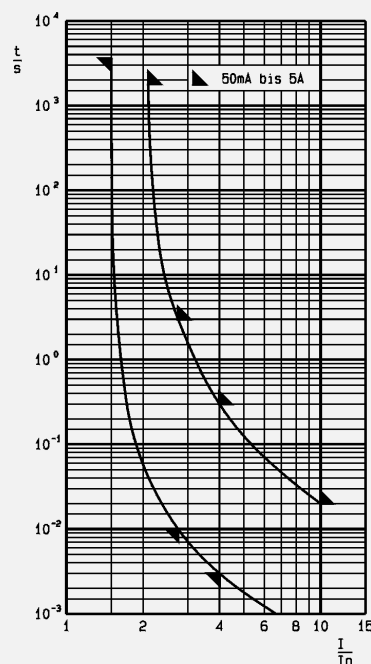

Kleinstsicherungen mit radialen Anschlußdrähten
Sub-miniature fuse-links with radial terminations

Bauform IEC 60127-3
design acc. to IEC 60127-3

Thermoplast, schwarz
temperaturbeständig
selbstverlöschend
Thermoplastic, black
temperature resistant
self-extinguishing

M mittelträge
medium time-lag

Anschlußstifte 0,6 mm ø, verzinkt
löt- oder steckbar
Terminations 0,6 mm ø, tinned
solderable or pluggable

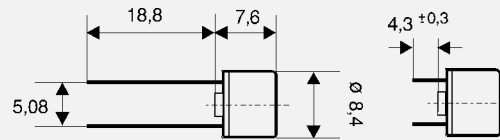

Art.-Nr.	Bemessungsstrom rated current	Spannungsabfall voltage drop mV max.	Schmelzintegral I ² t-value A ² s	Verlustleistung Power loss bei/at 1,5 x I _{rat} mW	Bemessungs- ausschaltvermögen rated breaking capacity	Bemessungs- spannung rated voltage	Approbationen Approvals SEMKO
	160 mA	325	0,075	140			
	200 mA	120	0,020	80			
	250 mA	120	0,036	90			
	315 mA	120	0,055	120			
	400 mA	110	0,11	140			
70 159 02¹⁾	500 mA	100	0,20	160	L _I 35 A bei / at 250 V 50 Hz COS φ = 1,0	250 V	
70 160 02²⁾	630 mA	90	0,33	180			
70 161 02³⁾	800 mA	80	0,58	140			
	1 A	70	0,9	160			
	1,25 A	65	1,4	190			
	1,6 A	65	2,5	200			
	2 A	60	3,1	350			
	2,5 A	55	5,2	380			
	3,15 A	55	9,9	510			
	4 A	50	16	550			40 A

1) kurze Stifte / short pins (4,3^{±0,3} mm)
2) lange Stifte / long pins (18,8^{±0,3} mm)
3) gegurtet / on tape

Grenzwerte der Schmelzzeit / pre-arcing time limits

Bemessungsstrom rated current	1,5 I _{rat}	2,1 I _{rat}	2,75 I _{rat}	4 I _{rat}	10 I _{rat}
160 mA - 4 A	> 1 h	< 30 min.	-	30 ms ... 2 s	4 ms ... 80 ms

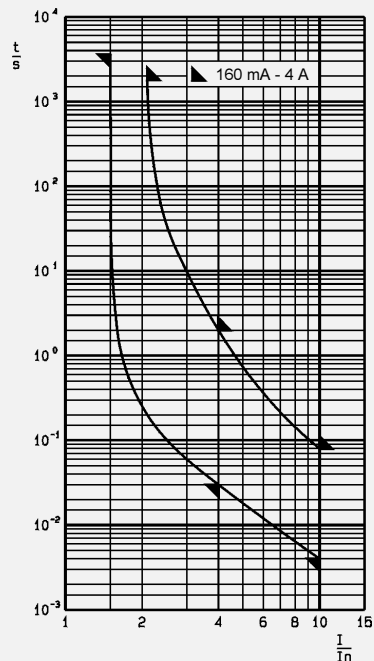

Gewicht / weight: 0,1 kg/100

Verpackungseinheit / packing unit: 100 Stück/pcs.

Kleinstsicherungen mit radialen Anschlußdrähten
Sub-miniature fuse-links with radial terminations

Thermoplast, schwarz
temperaturbeständig
selbstverlöschend
Thermoplastic, black
temperature resistant
self-extinguishing

DIN VDE 0820-3/4
IEC 60127-3/4
EN 60127-3/4

Approbationen / approvals



Anschlußstifte 0,6 mm ø, verzinkt
löt- oder steckbar
Terminations 0,6 mm ø, tinned
solderable or pluggable

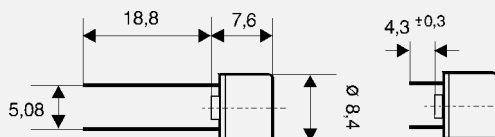

ELU Type
166 000
166 050

Art.-Nr.	Bemessungsstrom rated current	Spannungsabfall voltage drop mV max.	Schmelzintegral I ² t-value A ² s	Verlustleistung Power loss bei/at 1,5 x I _{rat} mW	Bemessungs- ausschaltvermögen rated breaking capacity	Bemessungs- spannung rated voltage	Approbationen Approvals		
							SEMKO	VDE	UL reg.
	40 mA	600	0,015	60			•	•	•
	50 mA	550	0,017	70			•	•	•
	63 mA	480	0,02	80			•	•	•
	80 mA	400	0,035	90			•	•	•
	100 mA	350	0,06	100			•	•	•
	125 mA	300	0,12	110			•	•	•
	160 mA	280	0,21	130			•	•	•
	200 mA	260	0,32	140			•	•	•
	250 mA	240	0,50	150			•	•	•
	315 mA	220	0,80	160			•	•	•
70 159 73¹⁾	400 mA	200	1,1	170	L _I 35 A bei / at 250 V 50 Hz	250 V	•	•	•
70 160 73²⁾	500 mA	190	1,8	180			•	•	•
70 161 73³⁾	630 mA	180	3,2	200	COS φ = 1,0		•	•	•
	800 mA	160	5,2	220			•	•	•
	1 A	140	8	240			•	•	•
	1,25 A	130	12	290			•	•	•
	1,6 A	120	22	350			•	•	•
	2 A	100	30	480			•	•	•
	2,5 A	100	46	520			•	•	•
	3,15 A	100	80	600			•	•	•
	4 A	100	130	800	40 A 50 A		•	•	•
	5 A	100	130	1000			•	•	•

1) kurze Stifte / short pins (4,3^{+0,3} mm)
2) lange Stifte / long pins (18,8^{+0,3} mm)
3) gegurtet / on tape

4) Gutachten / report

Grenzwerte der Schmelzzeit / pre-arcing time limits

Bemessungsstrom rated current	1,5 I _{rat}	2,1 I _{rat}	2,75 I _{rat}	4 I _{rat}	10 I _{rat}
40 mA ... 5 A	> 1 h	< 2 min.	400 ms ... 10 s	150 ms ... 3 s	20 ms ... 150 ms

Gewicht / weight: 0,1 kg/100

Verpackungseinheit / packing unit: 100 Stück/pcs.

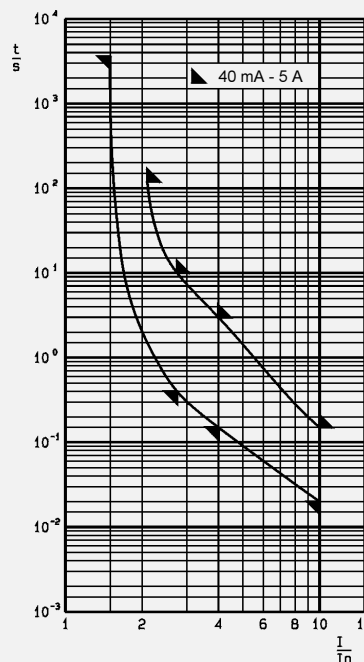

Kleinstsicherungen mit radialen Anschlußdrähten
Sub-miniature fuse-links with radial terminations

UL 248-14
CSA C22.2 No. 248.14

Thermoplast, schwarz
temperaturbeständig
selbstverlöschend
Thermoplastic, black
temperature resistant
self-extinguishing

Approbationen / approvals

F flink
quick-action

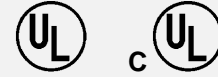

Anschlußstifte 0,6 mm ø, verzinkt
löt- oder steckbar
Terminations 0,6 mm ø, tinned
solderable or pluggable

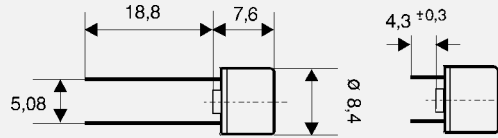

ELU Type
164 500
164 550

Art.-Nr.	Bemessungsstrom rated current	Spannungsabfall voltage drop mV max.	Schmelzintegral I ² t-value A ² s	Verlustleistung Power loss bei/at 1,0 x I _{rat} mW	Bemessungs- ausschaltvermögen rated breaking capacity	Bemessungs- spannung rated voltage	Approbationen Approvals	
							UL	cUL
	50 mA	1500	0,0002	75			•	•
	63 mA	1350	0,0003	85			•	•
	80 mA	1200	0,0007	95			•	•
	100 mA	1100	0,0015	110			•	•
	125 mA	1000	0,0030	125			•	•
	160 mA	950	0,0075	155			•	•
	200 mA	850	0,013	170			•	•
	250 mA	240	0,020	60			•	•
	315 mA	230	0,030	75			•	•
70 162 71¹⁾	400 mA	220	0,055	90	50 A		•	•
70 163 71²⁾	500 mA	210	0,10	105	bei / at	250 V	•	•
70 164 71³⁾	630 mA	200	0,19	130	250 V 50 Hz		•	•
	800 mA	190	0,36	155	COS φ ≥ 0,95		•	•
	1 A	180	0,14	180			•	•
	1,25 A	170	0,24	215			•	•
	1,6 A	160	0,34	260			•	•
	2 A	150	0,56	300			•	•
	2,5 A	140	1,1	350			•	•
	3,15 A	130	2,0	410			•	•
	4 A	120	3,2	480			•	•
	5 A	110	6,2	550			•	•
	6,3 A	100	14	630			•	•

1) kurze Stifte / short pins (4,3^{±0,3} mm)
2) lange Stifte / long pins (18,8^{±0,3} mm)
3) gegurtet / on tape

Grenzwerte der Schmelzzeit / pre-arcing time limits

Bemessungsstrom rated current	100 % I _{rat}	200 % I _{rat}
50 mA ... 6,3 A	> 4 h	< 60 s

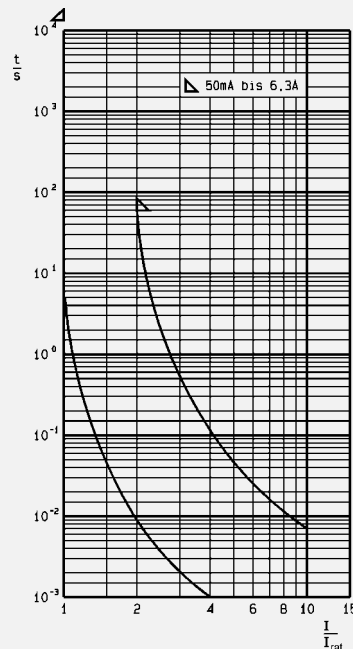

Gewicht / weight: 0,1 kg/100

Verpackungseinheit / packing unit: 100 Stück/pcs.

Kleinstsicherungen mit radialen Anschlußdrähten
Sub-miniature fuse-links with radial terminations

UL 248-14
CSA C22.2 No. 248.14

Thermoplast, schwarz
temperaturbeständig
selbstverlöschend
Thermoplastic, black
temperature resistant
self-extinguishing

Approbationen / approvals

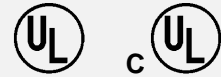

Anschlußstifte 0,6 mm ø, verzinkt
löt- oder steckbar
Terminations 0,6 mm ø, tinned
solderable or pluggable

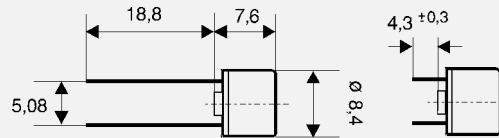

ELU Type
166 500
166 550

Art.-Nr.	Bemessungsstrom rated current	Spannungsabfall voltage drop mV max.	Schmelzintegral I ² t-value A ² s	Verlustleistung Power loss bei/at 1,5 x I _{rat} mW	Bemessungs- ausschaltvermögen rated breaking capacity	Bemessungs- spannung rated voltage	Approbationen Approvals		
							UL	ULc	
	50 mA	800	0,015	50			•	•	
	63 mA	700	0,017	50			•	•	
	80 mA	600	0,020	50			•	•	
	100 mA	550	0,025	55			•	•	
	125 mA	500	0,030	65			•	•	
	160 mA	450	0,070	75			•	•	
	200 mA	400	0,14	80			•	•	
	250 mA	370	0,25	95			•	•	
	315 mA	340	0,42	110			•	•	
70 162 76¹⁾	400 mA	310	0,53	130	50 A	250 V	•	•	
70 163 76²⁾	500 mA	270	1,0	140	bei / at			•	•
70 164 76³⁾	630 mA	230	1,5	150	250 V 50 Hz			•	•
	800 mA	220	3,1	180	COS φ ≥ 0,95			•	•
	1 A	200	4,8	200				•	•
	1,25 A	120	5,7	150				•	•
	1,6 A	120	11	190				•	•
	2 A	115	18	230				•	•
	2,5 A	110	25	280				•	•
	3,15 A	100	40	320				•	•
	4 A	95	72	380				•	•
	5 A	90	130	450				•	•
	6,3 A	90	130	570				•	•

1) kurze Stifte / short pins (4,3^{±0,3} mm)
2) lange Stifte / long pins (18,8^{±0,3} mm)
3) gegurtet / on tape

Grenzwerte der Schmelzzeit / pre-arcing time limits

Bemessungsstrom rated current	100 % I _{rat}	200 % I _{rat}
50 mA ... 6,3 A	> 4 h	< 60 s

Gewicht / weight: 0,1 kg/100

Verpackungseinheit / packing unit: 100 Stück/pcs.

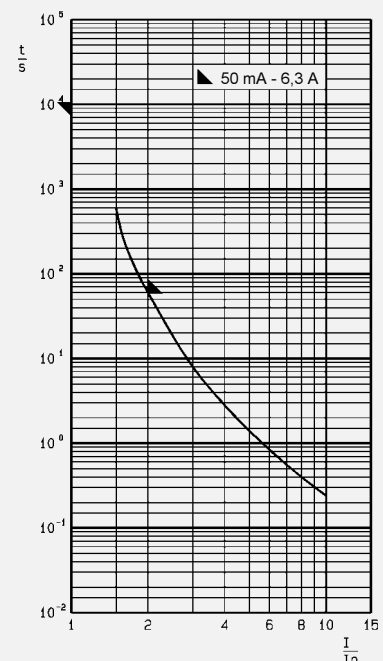

G-Sicherungseinsätze
miniature fuse links

DIN VDE 0820 Teil 2 Normblatt 2
IEC 60127-2/2
EN 60127-2/2

Approbationen / approvals

Glasrohr (durchsichtig)
glass tube (transparent)

F flink
quick-acting



verwechselbar
interchangeable

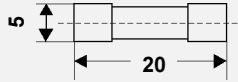

ELU Type
179 020

Art.-Nr.	Bemessungsstrom rated current	Spannungsabfall voltage drop mV max.	Schmelzintegral I ² t-value A ² s	Verlustleistung Power loss bei/at 1,5 x I _{rat} W	Bemessungs- ausschaltvermögen rated breaking capacity	Bemessungs- spannung rated voltage	Approbationen Approvals				
							SEMKO	VDE	SEV	BEAB	UL Rec.
70 001 34	32 mA	10000	0,0001	0,8	L I 35 A bei / at 250 V 50 Hz	250 V	•	•	•	•	•
	40 mA	8000	0,0002	0,8			•	•	•	•	•
	50 mA	7000	0,0004	0,4			•	•	•	•	•
	63 mA	5000	0,0007	0,5			•	•	•	•	•
	80 mA	4000	0,0017	0,5			•	•	•	•	•
	100 mA	3500	0,0022	0,6			•	•	•	•	•
	125 mA	2000	0,0036	0,6			•	•	•	•	•
	160 mA	2000	0,0082	0,7			•	•	•	•	•
	200 mA	1700	0,018	0,7			•	•	•	•	•
	250 mA	1400	0,047	0,8			•	•	•	•	•
	315 mA	1300	0,067	0,9	•	•	•	•	•		
	400 mA	1200	0,14	1,0	•	•	•	•	•		
	500 mA	1000	0,16	0,3	•	•	•	•	•		
	630 mA	650	0,39	0,3	•	•	•	•	•		
	800 mA	240	0,80	0,4	•	•	•	•	•		
	1 A	200	1,5	0,5	•	•	•	•	•		
	1,25 A	200	2,0	0,6	•	•	•	•	•		
	1,6 A	190	4,1	0,7	•	•	•	•	•		
	2 A	170	6,2	0,9	•	•	•	•	•		
	2,5 A	170	11	1,0	•	•	•	•	•		
3,15 A	150	20	1,2	•	•	•	•	•			
4 A	130	25	1,4	40 A	•	•	•	•			
5 A	130	42	1,7	50 A	•	•	•	•			
6,3 A	130	79	2,0	63 A	•	•	•	•			
(8 A)	120	125	2,2	80 A	•	•	•	•			
(10 A)	100	220	2,4	100 A	•	•	•	•			

(...) nicht genormt / not standardized

Grenzwerte der Schmelzzeit / pre-arcing time limits

Bemessungsstrom rated current	1,5 I _{rat}	2,1 I _{rat}	2,75 I _{rat}	4 I _{rat}	10 I _{rat}
32 mA ... 100 mA	> 1 h	< 30min	10 ms ... 500 ms	3 ms ... 100 ms	< 20 ms
125 mA ... 6,3 A			50 ms ... 2 s	10 ms ... 300 ms	

Gewicht / weight: 0,1 kg/100

Verpackungseinheit / packing unit: 100 Stück/pcs.

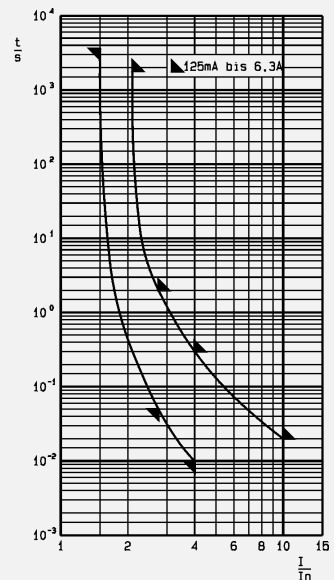
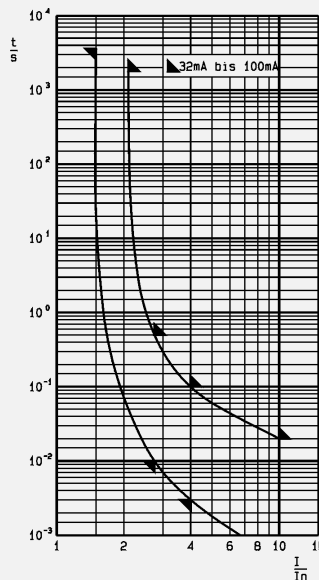

G-Sicherungseinsätze
miniature fuse links

DIN VDE 0820 Teil 2 Normblatt 1
IEC 60127-2/1
EN 60127-2/1

Approbationen / approvals

Keramikrohr (undurchsichtig)
ceramic tube (non-transparent)

F flink
quick-acting



SEMKO

verwechselbar
interchangeable



ELU Type
179 021

Art.-Nr.	Bemessungsstrom rated current	Spannungsabfall voltage drop mV max.	Schmelzintegral I ² t-value A ² s	Verlustleistung Power loss bei/at 1,5 x I _{rat} W	Bemessungs- ausschaltvermögen rated breaking capacity	Bemessungs- spannung rated voltage	Approbationen Approvals SEMKO
	50 mA	10000	0,00022	0,5			
	63 mA	8800	0,00037	0,6			
	80 mA	7600	0,00073	0,7			
	100 mA	7000	0,0011	0,8			
	125 mA	5000	0,0018	0,9			
	160 mA	4300	0,0034	0,9			
	200 mA	3500	0,007	1,0			
	250 mA	2800	0,013	1,0			
	315 mA	2500	0,01	0,8			
	400 mA	2000	0,017	0,9			
	500 mA	1800	0,03	1,0			
70 007 33	630 mA	1500	0,06	1,1	H I 1500 A bei / at 250 V 50 Hz	250 V	•
	800 mA	1200	0,12	1,3			
	1 A	1000	0,28	1,4			
	1,25 A	800	0,6	1,6			
	1,6 A	600	1,0	1,8			
	2 A	500	1,8	2,0			
	2,5 A	400	3,0	2,1			
	3,15 A	350	6,2	2,2			
	4 A	300	15	2,3			
	5 A	250	31	2,4			
	6,3 A	200	52	2,6			
	(8 A)	180	110	2,8			
	(10 A)	170	200	3,0			
	(12,5 A)	160	300				
	(16 A)	160	580				

(...) nicht genormt / not standardized

* Bei Verwendung dieser G-Sicherungseinsätze ist auf ausreichende Wärmeabfuhr zu achten. / When using this type, consideration should be given to heat dissipation

Grenzwerte der Schmelzzeit / pre-arcing time limits

Bemessungsstrom rated current	1,5 I _{rat}	2,1 I _{rat}	2,75 I _{rat}	4 I _{rat}	10 I _{rat}
50 mA ... 3,15 A			10 ms... 2 s	3 ms ... 300 ms	< 20 ms
4 A ... 6,3 A	> 1 h	< 30min	10 ms ... 3 s		

Gewicht / weight: 0,13 kg/100

Verpackungseinheit / packing unit: 100 Stück/pcs.

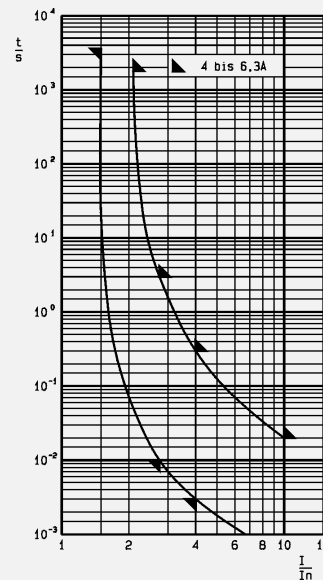
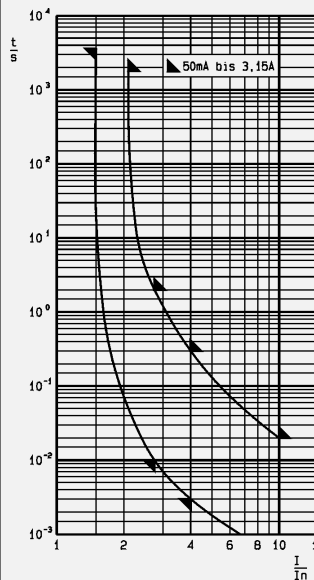

G-Sicherungseinsätze
miniature fuse links

DIN 41 571 Teil 1 *
nicht mehr gültig / not longer valid

Glasrohr (mit Löschmittelfüllung)
glass tube (with filling)

F flink
quick-acting

* DIN 41 571, Teil 1 ist ab Januar 1981
ersetzt durch DIN 41660 - 41 661
DIN 41 571, sheet 1, has been replaced
in January 1981 by DIN 41 660 - 41 661

verwechselbar
interchangeable

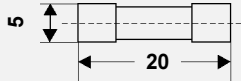

Art.-Nr.	Bemessungsstrom rated current	Spannungsabfall voltage drop mV max.	Schmelzintegral I ² t-value A ² s	Verlustleistung Power loss bei/at 1,5 x I _{rat} W	Bemessungs- ausschaltvermögen rated breaking capacity	Bemessungs- spannung rated voltage	Approbationen Approvals	
70 004 01	1,6 A	480	1,1	1,3	E _I 1000 A bei / at 250 V AC	250 V		
	2 A	400	2	1,5				
	2,5 A	400	4	1,6				
	3,15 A	240	9	1,7				
	4 A	240	18	1,9				
	5 A	230	32	2,3				
	6,3 A	170	52	2,8				
	(8 A)*	160	100	3,2				D _I 300 A
	(10 A)*	150	200	3,4				

(...) nicht genormt / not standardized

* Bei Verwendung dieser G-Sicherungseinsätze ist auf ausreichende Wärmeabfuhr zu achten. / When using this type, consideration should be given to heat dissipation

Grenzwerte der Schmelzzeit / pre-arcing time limits

Bemessungsstrom rated current	1,5 I _{rat}	2,1 I _{rat}	4 I _{rat}	10 I _{rat}
1,6 A ... 6,3 A	> 1 h	< 30 min.	< 0,3 s	< 20 ms

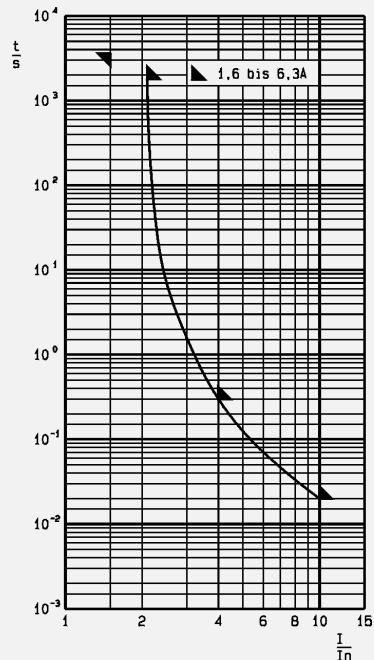

Gewicht / weight: 0,13 kg/100

Verpackungseinheit / packing unit: 100 Stück/pcs.

G-Sicherungseinsätze
miniature fuse links

DIN 41 571 T. 2

Glasrohr (durchsichtig) bis 1,25 A
 Glasrohr (undurchsichtig) bis 1,6 A
 glass tube (transparent) up to 1,25 A
 glass tube (with filling) up to 1,6 A

M mittelträge
 medium time-lag

verwechselbar
 interchangeable

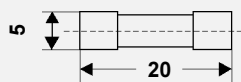

Art.-Nr.	Bemessungsstrom rated current	Spannungsabfall voltage drop mV max.	Schmelzintegral I ² t-value A ² s	Verlustleistung Power loss bei/at 1,5 x I _{rat} W	Bemessungs- ausschaltvermögen rated breaking capacity	Bemessungs- spannung rated voltage	Approbationen Approvals
70 001 02	32 mA	640	0,0055	0,1	C I 80 A bei / at 250 V 50 Hz	250 V	
	40 mA	630	0,0080	0,1			
	50 mA	600	0,017	0,1			
	63 mA	560	0,025	0,1			
	80 mA	520	0,040	0,1			
	100 mA	470	0,055	0,1			
	125 mA	420	0,011	0,1			
	160 mA	370	0,036	0,1			
	200 mA	320	0,050	0,2			
	250 mA	280	0,1	0,2			
	315 mA	250	0,2	0,2			
	400 mA	230	0,4	0,2			
	500 mA	210	0,6	0,2			
	630 mA	190	0,9	0,2			
70 004 02	800 mA	170	1,6	0,3	E I 1000 A bei / at 250 V 50 Hz		
	1 A	160	2,6	0,3			
	1,25 A	160	3,9	0,3			
	1,6 A	160	3,1	0,8			
	2 A	160	5,2	0,8			
	2,5 A	160	10	0,9			
	3,15 A	160	20	1,0			
	4 A	160	37	1,1			
	5 A	150	72	1,3			
	6,3 A	140	130	1,6			
	8 A*	140	230	2,0			
	10 A*	120	370	2,5			
				D I 300 A			

* Bei Verwendung dieser G-Sicherungseinsätze ist auf ausreichende Wärmeabfuhr zu achten. / When using this type, consideration should be given to heat dissipation

Grenzwerte der Schmelzzeit / pre-arcing time limits

Bemessungsstrom rated current	1,5 I _{rat}	2,1 I _{rat}	4 I _{rat}	10 I _{rat}
32 mA ... 1,25 A	> 1 h	< 10 min.	40 ms ... 2 s	5 ms ... 90 ms
1,6 A ... 10 A		< 30 min.		

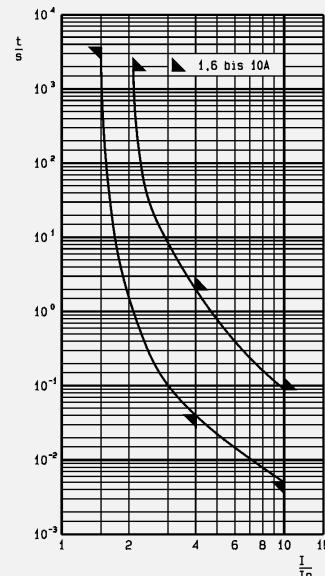
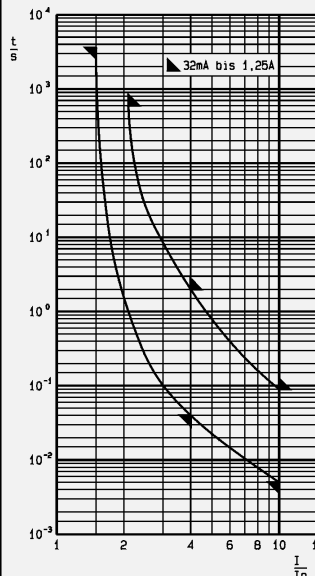

Gewicht / weight: art.: 7000102 0,1 kg/100
 7000402 0,12 kg/100

Verpackungseinheit / packing unit: 100 Stück/pcs.

G-Sicherungseinsätze
miniature fuse links

Sonderausführung (nicht genormt)
Special type (not standardized)

Keramikrohr (undurchsichtig)
ceramic tube (non-transparent)

M mittelträge
medium time-lag

verwechselbar
interchangeable

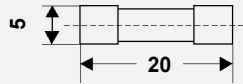

Art.-Nr.	Bemessungsstrom rated current	Spannungsabfall voltage drop mV max.	Schmelzintegral I ² t-value A ² s	Verlustleistung Power loss bei/at 1,5 x I _{rat} W	Bemessungs- ausschaltvermögen rated breaking capacity	Bemessungs- spannung rated voltage	Approbationen Approvals
70 007 02	125 mA	2500	0,011	0,1	G I 1500 A bei / at 250 V 50 Hz	250 V	
	160 mA	2000	0,036	0,1			
	200 mA	1800	0,050	0,2			
	250 mA	1600	0,1	0,2			
	315 mA	1400	0,2	0,2			
	400 mA	1200	0,4	0,2			
	500 mA	800	0,6	0,2			
	630 mA	650	0,6	0,4			
	800 mA	500	1,0	0,6			
	1 A	450	1,5	0,8			
	1,25 A	400	3,1	0,8			
	1,6 A	160	3,1	0,8			
	2 A	160	5,2	0,8			
	2,5 A	160	10	0,9			
	3,15 A	160	20	1,0			
	4 A	160	37	1,1			
	5 A	150	72	1,3			
6,3 A	140	130	1,6				
8 A*	140	230	2,0				
10 A*	120	370	2,5				

* Bei Verwendung dieser G-Sicherungseinsätze ist auf ausreichende Wärmeabfuhr zu achten. / When using this type, consideration should be given to heat dissipation

Grenzwerte der Schmelzzeit / pre-arcing time limits

Bemessungsstrom rated current	1,5 I _{rat}	2,1 I _{rat}	4 I _{rat}	10 I _{rat}
125 mA ... 10 A	> 1 h	< 30 min.	40 ms ... 2 s	5 ms ... 90 ms

Gewicht / weight: Art.: 0,14 kg/100

Verpackungseinheit / packing unit: 100 Stück/pcs.

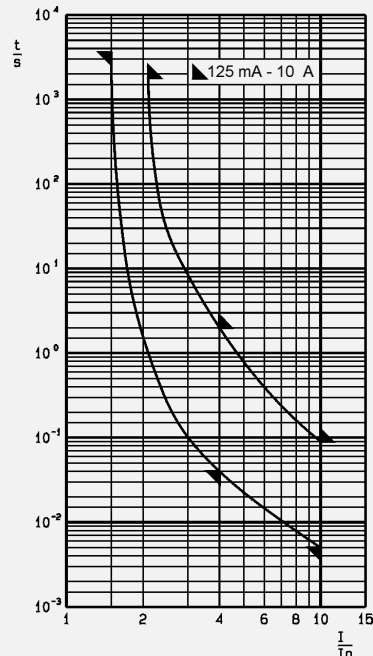

G-Sicherungseinsätze
miniature fuse links

DIN VDE 0820 Teil 2 Normblatt 3
IEC 60 127-2/3
EN 60 127-2/3

Approbationen / approvals

Glasrohr (durchsichtig)
glass tube (transparent)



verwechselbar
interchangeable



ELU Type
179 120

Art.-Nr.	Bemessungsstrom rated current	Spannungsabfall voltage drop mV max.	Schmelzintegral I ² t-value A ² s	Verlustleistung Power loss bei/at 1,5 x I _{rat} W	Bemessungs- ausschaltvermögen rated breaking capacity	Bemessungs- spannung rated voltage					
							SEMKO	VDE	SEV	BEAB	UL Rec.
70 001 35	32 mA	5000	0,010	0,2	L I 35 A bei / at 250 V 50 Hz	250 V	•	•	•	•	•
	40 mA	4000	0,020	0,2			•	•	•	•	•
	50 mA	3500	0,035	0,2			•	•	•	•	•
	63 mA	3000	0,050	0,2			•	•	•	•	•
	80 mA	3000	0,12	0,2			•	•	•	•	•
	100 mA	2500	0,16	0,3			•	•	•	•	•
	125 mA	2000	0,24	0,3			•	•	•	•	•
	160 mA	1900	0,40	0,3			•	•	•	•	•
	200 mA	1500	0,70	0,3			•	•	•	•	•
	250 mA	1300	1,4	0,3			•	•	•	•	•
	315 mA	1100	2,1	0,3			•	•	•	•	•
	400 mA	1000	0,6	0,2			•	•	•	•	•
	500 mA	900	0,9	0,2			•	•	•	•	•
	630 mA	300	1,6	0,2			•	•	•	•	•
	800 mA	250	3,5	0,3			•	•	•	•	•
	1 A	150	3,9	0,3			•	•	•	•	•
	1,25 A	150	5,0	0,3			•	•	•	•	•
	1,6 A	150	10	0,4			•	•	•	•	•
	2 A	150	20	0,5			•	•	•	•	•
	2,5 A	120	26	0,6			•	•	•	•	•
3,15 A	100	44	0,6	•	•	•	•	•			
4 A	100	72	0,8	40 A	•	•	•	•			
5 A	100	130	1,2	50 A	•	•	•	•			
6,3 A	100	230	1,3	63 A	•	•	•	•			
(8 A)	100	240	1,8	80 A	•	•	•	•			
(10 A)	100	380	2,4	100 A	•	•	•	•			
(12,5 A)	100	650	3,0	125 A	•	•	•	•			

(...) nicht genormt / not standardized

Grenzwerte der Schmelzzeit / pre-arcing time limits

Bemessungsstrom rated current	1,5 I _{rat}	2,1 I _{rat}	2,75 I _{rat}	4 I _{rat}	10 I _{rat}
32 mA ... 100 mA	> 1 h	< 2min	200 ms... 10 s	40 ms ... 3 s	10 ms ... 300 ms
125 mA ... 6,3 A			600 ms ... 10 s	150 ms ... 3 s	20 ms ... 300 ms

Gewicht / weight: 0,1 kg/100

Verpackungseinheit / packing unit: 100 Stück/pcs.

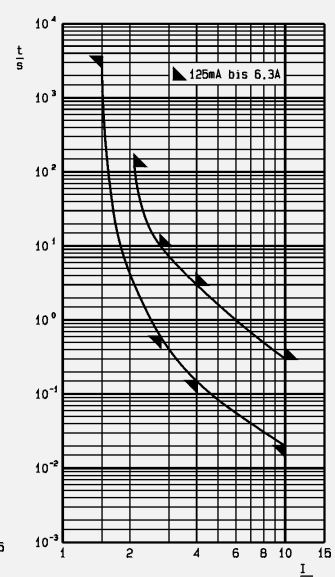
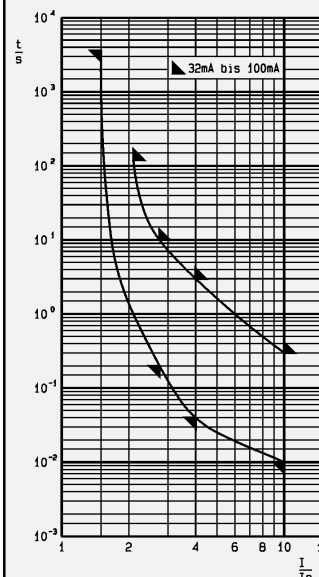

G-Sicherungseinsätze
miniature fuse links

DIN 41 571 Teil 3

Glasrohr (mit Löschmittelfüllung)
glass tube (with filling)



verwechselbar
interchangeable

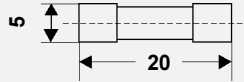

Art.-Nr.	Bemessungsstrom rated current	Spannungsabfall voltage drop mV max.	Schmelzintegral I ² t-value A ² s	Verlustleistung Power loss bei/at 1,5 x I _{rat} W	Bemessungs- ausschaltvermögen rated breaking capacity	Bemessungs- spannung rated voltage	Approbationen Approvals
70 004 03	1,6 A	200**	16	0,8	D _I 300 A bei / at 250 V 50 Hz	250 V	
	2 A	190**	26	0,9			
	2,5 A	180**	45	1,1			
	3,15 A	140	72	1,3			
	4 A	135	130	1,4			
	5 A	130	150	1,2			
	6,3 A	125	240	1,3			
	8 A*	120	390	1,6			
	10 A*	115	620	1,9			
	12,5 A*	100	1150	2,8			
	15 A*	80	1800	3,3			
16 A*	80	1800	3,8				

** max. nach / to EN 60 127-2/5

* Bei Verwendung dieser G-Sicherungseinsätze ist auf ausreichende Wärmeabfuhr zu achten. / When using this type, consideration should be given to heat dissipation

Grenzwerte der Schmelzzeit / pre-arcing time limits

Bemessungs- strom rated current	1,5 I _{rat}	2,1 I _{rat}	4 I _{rat}	10 I _{rat}
1,6 A ... 10 A	> 1 h	< 30 min.	0,3 ... 3 s	60 ... 300 ms

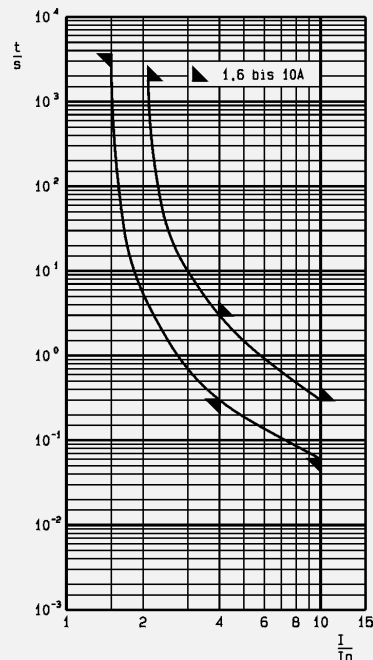

Gewicht / weight: 0,13 kg/100

Verpackungseinheit / packing unit: 100 Stück/pcs.

G-Sicherungseinsätze
miniature fuse links

DIN VDE 0820-2/5
IEC 60 127-2/5
EN 60 127-2/5

Approbationen / approvals

Keramikrohr (undurchsichtig)
ceramic tube (non-transparent)



träge
time-lag



VDE



SEMKO



UL Rec.

verwechselbar
interchangeable

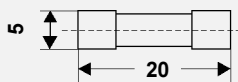

ELU Type
179 200

Art.-Nr.	Bemessungsstrom rated current	Spannungsabfall voltage drop mV max.	Schmelzintegral I ² t-value A ² s	Verlustleistung Power loss bei/at 1,5 x I _{rat} W	Bemessungs- ausschaltvermögen rated breaking capacity	Bemessungs- spannung rated voltage	Approbationen Approvals			
							SEMKO	VDE	BEAB	UL Rec.
70 007 65	100 mA	3500	0,020	0,6	H I 1500 A bei / at 250 V 50 Hz	250 V	•	•	•	•
	125 mA	3000	0,045	0,8						
	160 mA	2500	0,080	0,9						
	200 mA	2000	0,14	0,9						
	250 mA	1800	0,25	1,0						
	315 mA	1500	0,45	1,0						
	400 mA	1300	0,80	1,0						
	500 mA	1000	1,6	1,0						
	630 mA	800	0,6	0,4						
	800 mA	500	1,0	0,6						
	1 A	250	1,5	0,8						
	1,25 A	250	3,1	0,8						
	1,6 A	200	3,1	0,8						
	2 A	190	5,2	0,8						
	2,5 A	180	10	0,9						
	3,15 A	140	20	1,0						
4 A	100	37	1,1							
5 A	100	72	1,3							
6,3 A	100	130	1,6							
8 A*	100	230	2,0							
10 A*	100	370	2,5							

* Bei Verwendung dieser G-Sicherungseinsätze ist auf ausreichende Wärmeabfuhr zu achten. / When using this type, consideration should be given to heat dissipation

Grenzwerte der Schmelzzeit / pre-arcing time limits

Bemessungsstrom rated current	2,1 I _{rat}	2,75 I _{rat}	4 I _{rat}	10 I _{rat}
125 mA ... 3,15 A	< 30 min.	1 s ... 80 s	95 ms ... 5 s	10 ms ... 100 ms
4 A ... 6,3 A			150 ms ... 5 s	20 ms ... 100 ms

Gewicht / weight: Art.: 0,13 kg/100

Verpackungseinheit / packing unit: 100 Stück/pcs.

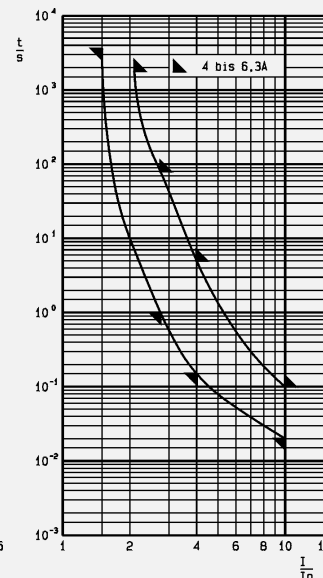
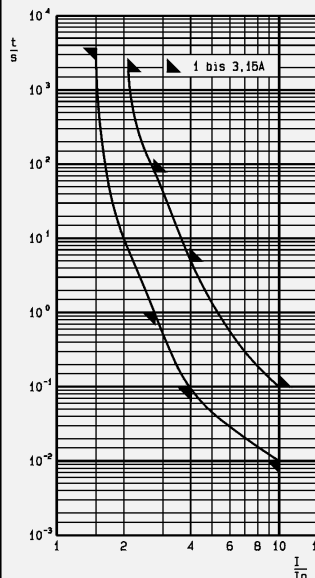

G-Sicherungseinsätze
miniature fuse links

DIN VDE 0820-2/6
IEC 60 127-2/6
EN 60 127-2/6

Approbationen / approvals

Glasrohr (durchsichtig)
glass tube (transparent)



verwechselbar
interchangeable

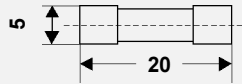

ELU Type
179 150

Art.-Nr.	Bemessungsstrom rated current	Spannungsabfall voltage drop mV max.	Schmelzintegral I ² t-value A ² s	Verlustleistung Power loss bei/at 1,5 x I _{rat} W	Bemessungs- ausschaltvermögen rated breaking capacity	Bemessungs- spannung rated voltage	Approbationen Approvals	
							VDE	SEMKO
70 001 79	32 mA	5000	0,010	0,2	E I 150 A bei / at 250 V 50 Hz	250 V	•	•
	40 mA	4000	0,020	0,2				
	50 mA	3500	0,035	0,2				
	63 mA	3000	0,050	0,2				
	80 mA	3000	0,12	0,2				
	100 mA	2500	0,16	0,3				
	125 mA	2000	0,24	0,3				
	160 mA	1900	0,40	0,3				
	200 mA	1500	0,70	0,3				
	250 mA	1300	1,4	0,3				
	315 mA	1100	2,1	0,3				
	400 mA	1000	0,6	0,2				
	500 mA	900	0,9	0,2				
	630 mA	300	1,6	0,2				
	800 mA	250	3,5	0,3				
	1 A	150	3,9	0,3				
	1,25 A	150	5,0	0,3				
	1,6 A	150	10	0,4				
2 A	150	20	0,5					
2,5 A	120	26	0,6					
3,15 A	100	44	0,6					
4 A	100	72	0,8					
5 A	100	130	1,2					
6,3 A	100	230	1,3					

Grenzwerte der Schmelzzeit / pre-arcing time limits

Bemessungsstrom rated current	1,5 I _{rat}	2,1 I _{rat}	2,75 I _{rat}	4 I _{rat}	10 I _{rat}
32 mA ... 6,3 A	> 1 h	< 2min	600 ms ... 10 s	150 ms ... 3 s	20 ms ... 300 ms

Gewicht / weight: Art.: 0,1 kg/100

Verpackungseinheit / packing unit: 100 Stück/pcs.

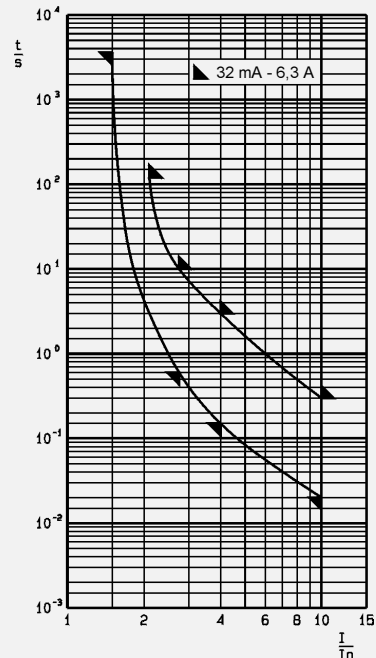

G-Sicherungseinsätze
miniature fuse links

UL 248-14
CSA C22.2 No. 248.14

Approbationen / approvals

Glasrohr (durchsichtig)
glass tube (transparent)

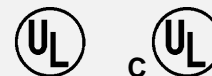

verwechselbar
interchangeable

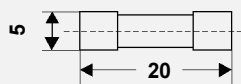

ELU Type
179 500

Art.-Nr.	Bemessungsstrom rated current	Spannungsabfall voltage drop mV max.	Schmelzintegral I ² -value A ² s	Verlustleistung Power loss bei/at 1,0 x I _{rat} W	Bemessungs- ausschaltvermögen rated breaking capacity	Bemessungs- spannung rated voltage	Approbationen Approvals			
							UL	cUL		
70 001 76	80 mA	2800	0,024	0,3	35 A (250 V AC)	250 V	•	•		
	100 mA	2400	0,053	0,3			•	•		
	125 mA	2100	0,080	0,3			•	•		
	150 mA	1800	0,13	0,3			•	•		
	200 mA	1300	0,24	0,3			•	•		
	250 mA	1100	0,42	0,3			•	•		
	300 mA	1050	0,80	0,4			•	•		
	375 mA	900	1,5	0,4			•	•		
	400 mA	850	1,6	0,4			•	•		
	500 mA	650	2,0	0,4			•	•		
	600 mA	550	3,1	0,4	10 000 A (125 V AC)	250 V	•	•		
	700 mA	500	4,5	0,4			•	•		
	750 mA	450	5,5	0,4			•	•		
	800 mA	400	6,4	0,4			•	•		
	1 A	350	12	0,4			•	•		
	1,25 A	300	19	0,4			•	•		
	1,5 A	280	25	0,5			•	•		
	1,6 A	270	32	0,5			•	•		
	2 A	235	55	0,5			(250 V AC)		•	•
	2,5 A	215	90	0,6					•	•
3 A	200	160	0,6	•	•					

Grenzwerte der Schmelzzeit / pre-arcing time limits

Bemessungsstrom rated current	100 % I _{rat}	135 % I _{rat}	200 % I _{rat}
80 mA ... 3 A	> 4 h	< 1 h	5 s ... 120 s

Gewicht / weight: Art.: 0,1 kg/100

Verpackungseinheit / packing unit: 100 Stück/pcs.

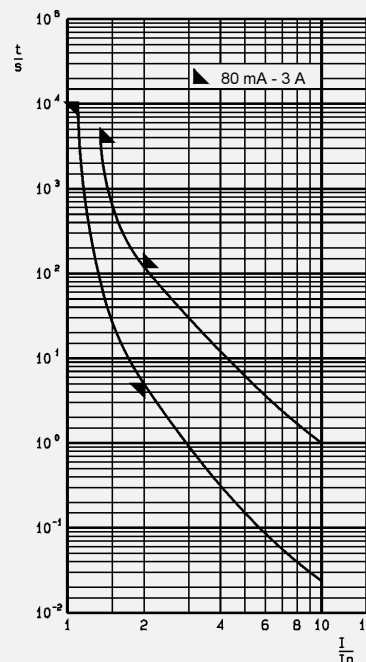

G-Sicherungseinsätze
miniature fuse links

Sonderausführung (nicht genormt)
Special Type (not standardized)

Keramicrohr (undurchsichtig)
ceramic tube (non-transparent)

FF

superflink
very quick-acting

Approbationen / approvals



verwechselbar
interchangeable

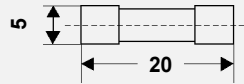

ELU Type
195 000

Art.-Nr.	Bemessungsstrom rated current	max. Spannungsfall max. voltage drop mV	Schmelzintegral I ² t _s -value A ² s	Total I ² t-Wert total I ² t-value A ² s	Bemessungs- ausschaltvermögen rated breaking capacity	Bemessungs- spannung rated voltage	Approbationen Approvals UL Rec.
70 001 40	100 mA	4000	0,0016	0,0023	300 kA bei/at AC 250 V cos phi < 0,2	AC 250 V	.
	125 mA	3500	0,0024	0,0034			
	160 mA	1300	0,004	0,0056			
	200 mA	1100	0,008	0,011			
	250 mA	1000	0,019	0,027			
	315 mA	900	0,030	0,042			
	400 mA	850	0,065	0,090			
	500 mA	800	0,12	0,17			
	630 mA	700	0,17	0,24			
	800 mA	600	0,26	0,36			
	1 A	750	0,17	0,26			
	1,25 A	750	0,26	0,39			
	1,6 A	700	0,31	0,51			
	2 A	650	0,64	1,0			
	2,5 A	600	0,88	1,5			
	3,15 A	550	1,6	2,7			
4 A	500	3,2	5,4				
5 A	500	5,9	10				
6,3 A	450	10	17	1500 A bei / at AC 250 V	.		
8 A	400	19	32				
10 A	400	30	54				
70 007 40	6,3 A	250	1,6	4,8	300 kA bei/at AC 250 V cos phi < 0,2	.	
	8 A	250	4,5	14			
	10 A	200	8,8	26			
	12,5 A	200	15	44			

Grenzwerte der Schmelzzeit / pre-arcing time limits

Art.-Nr.: 70 001 40					
Bemessungs- strom rated current	1,0 I _{rat}	2,0 I _{rat}	2,75 I _{rat}	4 I _{rat}	10 I _{rat}
100 mA ... 800 mA	> 1 h			< 60 ms	< 6 ms
1 A ... 10 A		15 ms ... 1 s	4 ms ... 100 ms	1 ms ... 25 ms	< 3 ms
Art.-Nr.: 70 007 40					
Bemessungs- strom rated current	1,2 I _{rat}	1,5 I _{rat}	2,75 I _{rat}	4 I _{rat}	10 I _{rat}
6,3 A ... 12,5 A	> 1 h	< 30 min	4 ms ... 300 ms	1 ms ... 30 ms	< 1 ms

Gewicht / weight: Art.: 0,14 kg/100

Verpackungseinheit / packing unit: 100 Stück/pcs.

Art.-Nr.: 70 001 40

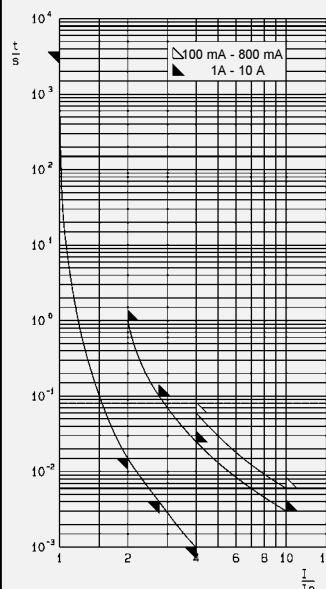

Art.-Nr.: 70 007 40

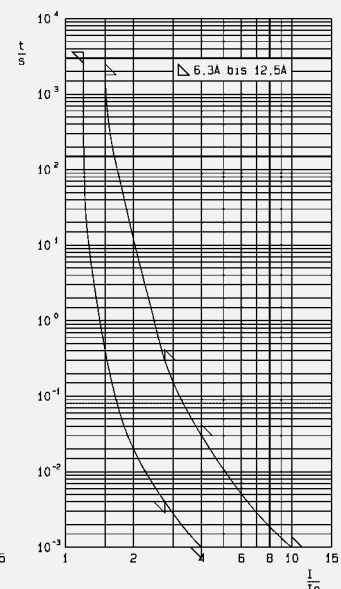

G-Sicherungseinsätze
miniature fuse links

DIN VDE 0820-2/4
IEC 60 127-2/4
EN 60 127-2/4

Glasrohr (durchsichtig)
glass tube (transparent)

F flink
quick-acting

verwechselbar
interchangeable

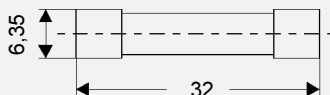

Art.-Nr.	Bemessungsstrom rated current	Spannungsabfall voltage drop mV max.	Schmelzintegral I ² t-value A ² s	Verlustleistung Power loss bei/at 1,15 x I _{rat} W	Bemessungs- ausschaltvermögen rated breaking capacity	Bemessungs- spannung rated voltage
	50 mA	10000	0,0003	0,7		
	63 mA	8000	0,0005	0,5		
	80 mA	7000	0,0010	0,6		
	100 mA	6000	0,0014	0,7		
	125 mA	5500	0,0034	0,7		
	160 mA	5000	0,0070	0,8		
	200 mA	4000	0,013	0,9		
	250 mA	3500	0,022	1,0		
	315 mA	3000	0,054	1,1		
	400 mA	2500	0,11	1,2		
	500 mA	2000	0,21	1,3		
	630 mA	1800	0,26	0,4		
	800 mA	1500	0,57	0,4		
70 059 60	1 A	500	1,1	0,5		
	1,25 A	400	2,0	0,6		
	1,6 A	400	3,3	0,7		
	2 A	300	6,2	0,8		
	2,5 A	250	13	0,9		
	3,15 A	250	24	1,1		
	4 A	250	40	1,3	40	
	5 A	200	80	1,4	50	
	6,3 A	200	150	1,6	63	
	8 A*	200	240	2,0	80	
	10 A*	200	500	2,3	100	
	12,5 A*	200	650	2,5	125	
	16 A*	200	1250	2,8	160	
	20 A*	200	1600	4,0	200	

L I 35 A
bei / at
250 V 50 Hz

250 V

* Bei Verwendung dieser G-Sicherungseinsätze ist auf ausreichende Wärmeabfuhr zu achten. / When using this type, consideration should be given to heat dissipation

Grenzwerte der Schmelzzeit / pre-arcing time limits

Bemessungsstrom rated current	1,15 I _{rat}	2 I _{rat}	2,75 I _{rat}	4 I _{rat}	10 I _{rat}
50 mA ... 100 mA			2 ms ... 200 ms	1 ms ... 30 ms	< 5 ms
125 mA ... 10 A	> 1 h	< 20 s	20 ms ... 1500 ms	8 ms ... 400 ms	< 80 ms

Gewicht / weight: 0,1 kg/100

Verpackungseinheit / packing unit: 100 Stück/pcs.

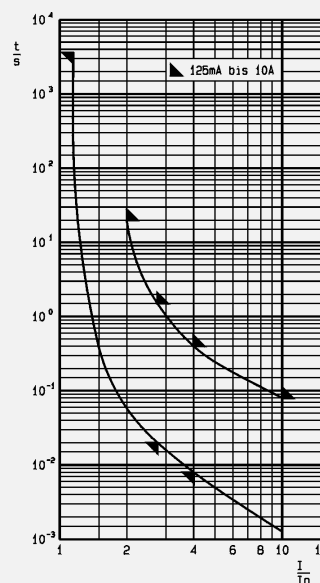
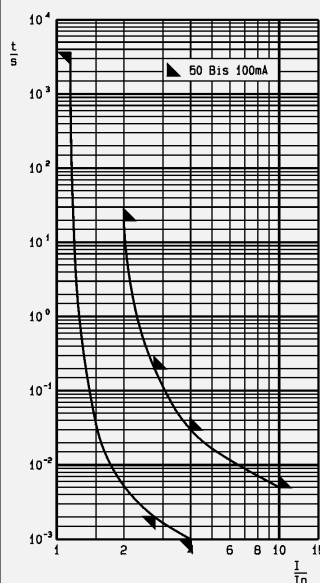

G-Sicherungseinsätze
miniature fuse links

Sonderausführung (nicht genormt)
Special type (not standardized)

Keramikrohr (undurchsichtig)
ceramic tube (non-transparent)

F flink
quick-acting

Approbationen / approvals



verwechselbar
interchangeable

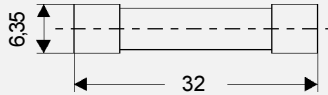

ELU Type
189 020

Art.-Nr.	Bemessungsstrom rated current	Spannungsabfall voltage drop mV max.	Schmelzintegral I ² t-value A ² s	Verlustleistung Power loss bei/at 1,5 x I _{rat} W	Bemessungs- ausschaltvermögen rated breaking capacity	Bemessungs- spannung rated voltage	Approbationen Approvals UL rec.
70 065 63	160 mA	7000	0,0015	2,5	1500 A bei / at 500 V AC COS φ = 1,0	10 kA 500 V	•
	200 mA	6500	0,0035	2,9			
	250 mA	6000	0,0085	3,4			
	315 mA	1000	0,025	0,9			
	400 mA	900	0,045	1,0			
	500 mA	800	0,09	1,1			
	630 mA	700	0,15	1,3			
	800 mA	600	0,30	1,4			
	1 A	400	0,40	1,2	50 kA	440 V AC COS φ = 0,3	•
	1,25 A	300	0,80	1,3	bei / at		
	1,6 A	300	1,5	1,4	500 V AC		
	2 A	280	2,5	1,6	COS φ = 1,0		
	2,5 A	260	5,0	1,8	20 kA		
	3,15 A	240	9,0	2,3	bei / at		
	4 A	220	18	2,6	500 V DC		
	5 A	190	40	2,9	L/R < 5 ms		
	6,3 A	170	80	3,2			
	8 A*	160	150	3,7			
10 A*	150	240	4,0	1500 A bei/at			
12,5 A*	140	500	5,5	500 V AC, COS φ =1			
16 A*	130	920	6,5				
20 A*	120	1500	8,4	1500 A bei/at	440 V		
25 A*	110	3100	10,5	440 V AC, COS φ =1			

* Bei Verwendung dieser G-Sicherungseinsätze ist auf ausreichende Wärmeabfuhr zu achten. / When using this type, consideration should be given to heat dissipation

Grenzwerte der Schmelzzeit / pre-arcing time limits

Bemessungsstrom rated current	1,5 I _{rat}	2,1 I _{rat}	2,75 I _{rat}	4 I _{rat}	10 I _{rat}
160 mA ... 800 mA	> 1 h	< 30 min.	20 ms... 1,5 s	8 ms ... 0,4 s	< 20 ms
1 A ... 25 A			100 ms... 5 s	20 ms ... 1 s	< 50 ms

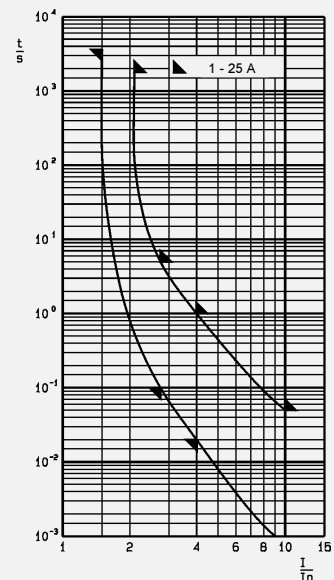
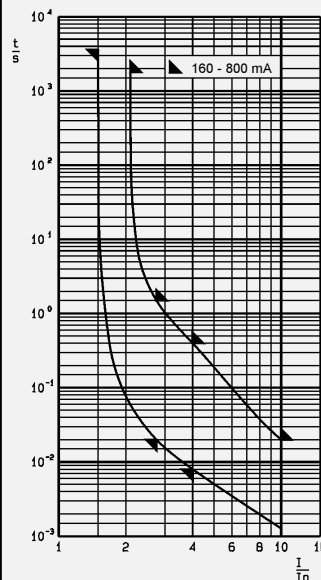

Gewicht / weight: 0,24 kg/100

Verpackungseinheit / packing unit: 100 Stück/pcs.

G-Sicherungseinsätze
miniature fuse links

Glasrohr (durchsichtig)
glass tube (transparent)



verwechselbar
interchangeable

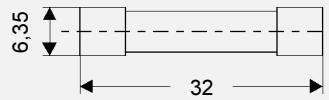

Art.-Nr.	Bemessungsstrom rated current	Spannungsabfall voltage drop mV max.	Schmelzintegral I^2t -value A ² s	Verlustleistung Power loss bei/at 1,5 x I _{rat} W	Bemessungs- ausschaltvermögen rated breaking capacity	Bemessungs- spannung rated voltage
	50 mA	3000	0,035	0,3		
	63 mA	2500	0,060	0,3		
	80 mA	2000	0,13	0,3		
	100 mA	1500	0,17	0,3		
	125 mA	1200	0,26	0,3		
	160 mA	1100	0,44	0,4		
	200 mA	1000	0,84	0,4		
	250 mA	900	1,5	0,5		
	315 mA	800	2,4	0,5		
	400 mA	300	0,6	0,2		
	500 mA	300	0,9	0,3		
	630 mA	300	1,6	0,3		
	800 mA	250	3,5	0,4		
	1 A	250	4,0	0,4		
	1,25 A	250	5,0	0,4		
	1,6 A	200	10	0,5		
	2 A	200	16	0,6		
	2,5 A	200	24	0,7		
	3,15 A	200	42	0,8		
	4 A	200	70	1,0	40 A	
	5 A	200	130	1,3	50 A	
	6,3 A	200	230	1,6	63 A	
	8 A*	200	370	2,0	80 A	
	10 A*	150	630	2,3	100 A	
	12,5 A*	150	820	2,8	125 A	
	16 A*	150	1200	3,0	160 A	
	20 A*	150	1600	4,0	200 A	
70 059 61					L I 35 A bei / at 250 V 50 Hz	250 V

* Bei Verwendung dieser G-Sicherungseinsätze ist auf ausreichende Wärmeabfuhr zu achten. / When using this type, consideration should be given to heat dissipation

Grenzwerte der Schmelzzeit / pre-arcing time limits

Bemessungsstrom rated current	1,15 I _{rat}	2 I _{rat}	2,75 I _{rat}	4 I _{rat}	10 I _{rat}
50 mA ... 20 A	> 1 h	800 ms ... 30 s	200 ms ... 6 s	80 ms ... 2 s	15 ms ... 300 ms

Gewicht / weight: 0,12 kg/100

Verpackungseinheit / packing unit: 100 Stück/pcs.

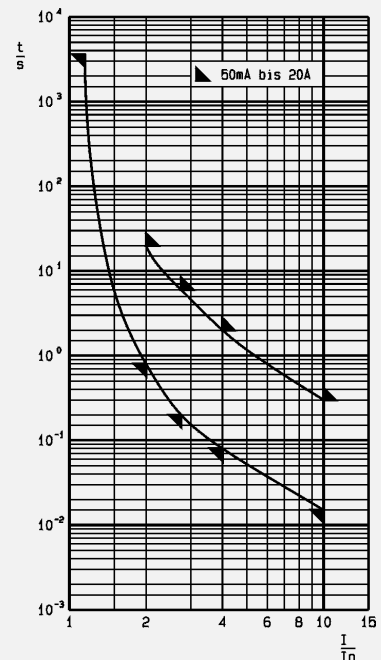

G-Sicherungseinsätze
miniature fuse links

Sonderausführung (nicht genormt)
Special type (not standardized)

Keramikrohr (undurchsichtig)
ceramic tube (non-transparent)



Approbationen / approvals



verwechselbar
interchangeable

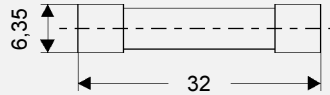

ELU Type
189 140

Art.-Nr.	Bemessungsstrom rated current	Spannungsabfall voltage drop mV max.	Schmelzintegral I ² t-value A ² s	Verlustleistung Power loss bei/at 1,5 x I _{rat} W	Bemessungs- ausschaltvermögen rated breaking capacity	Bemessungs- spannung rated voltage	Approbationen Approvals <small>UL rec.</small>
	100 mA	3600	0,05	1,3			
	125 mA	3400	0,08	1,4			
	160 mA	3000	0,12	1,5			
	200 mA	2500	0,20	1,6			
	250 mA	2000	0,35	1,7			
	315 mA	1800	0,50	1,8			
	400 mA	1600	0,80	2,0			
	500 mA	450	0,32	0,6			•
	630 mA	400	0,60	0,7	1500 A	10 kA	•
	800 mA	350	1,0	0,8	500 V AC	bei / at	•
	1 A	350	1,5	0,9	bei / at	440 V AC	•
	1,25 A	300	3,1	1,0	COS φ = 1,0	COS φ = 0,3	•
70 065 65	1,6 A	200	5,2	1,1		500 V	•
	2 A	180	10	1,2			•
	2,5 A	160	19	1,3			•
	3,15 A	150	37	1,4			•
	4 A	140	68	1,5			•
	5 A	135	80	2,2			•
	6,3 A	110	215	2,2			•
	8 A*	110	370	2,6			•
	10 A*	100	620	3,0			•
	12,5 A*	100	1300	3,5			•
	16 A*	100	2500	4,0			•
	20 A*	100	3400	6,0	1500 A bei/at		
	25 A*	100	5600	8,0	440 V AC, COS φ =1	440 V	
	32 A*	80	3900	10,0	1500 A bei/at	250 V	
					250 V AC, COS φ =1		

* Bei Verwendung dieser G-Sicherungseinsätze ist auf ausreichende Wärmeabfuhr zu achten. / When using this type, consideration should be given to heat dissipation

Grenzwerte der Schmelzzeit / pre-arcing time limits

Bemessungsstrom rated current	1,5 I _{rat}	2,1 I _{rat}	2,75 I _{rat}	4 I _{rat}	10 I _{rat}
100 mA ... 1,6 A	> 1 h	< 30 min.	400ms ...	95 ms ...	10 ms ...
2 A ... 32 A			80 s	5 s	300 ms
				150 ms ...	20 ms ...
				5 s	300 ms

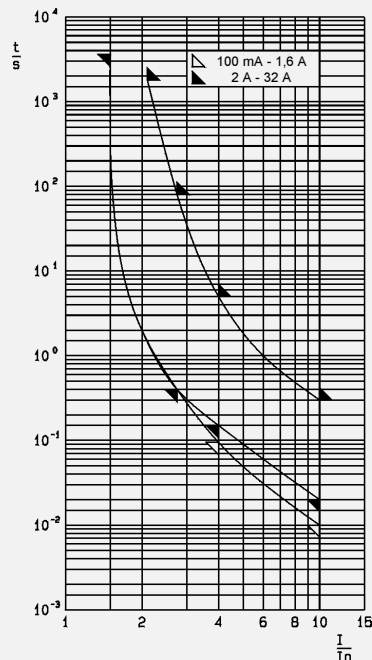

Gewicht / weight: 0,24 kg/100

Verpackungseinheit / packing unit: 100 Stück/pcs.

G-Sicherungseinsätze
miniature fuse links

UL 248-14
CSA C22.2 No. 248.14

Glasrohr (durchsichtig)
glass tube (transparent)

T
träge
time-lag

Approbationen / approvals



verwechselbar
interchangeable

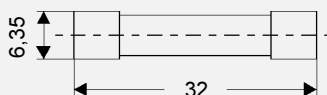

ELU Type
189 500

Art.-Nr.	Bemessungsstrom rated current	Spannungsabfall voltage drop mV max.	Schmelzintegral I ² t-value A ² s	Verlustleistung Power loss bei/at 1,5 x I _{rat} W	Bemessungs- ausschaltvermögen rated breaking capacity	Bemessungs- spannung rated voltage	Approbationen Approvals		
							UL	CSA	
70 059 76	300 mA	870	1,5	0,6	35 A bei / at 250 V	250 V	•	•	
	375 mA	840	2,5	0,6			•	•	
	400 mA	730	2,5	0,6			•	•	
	500 mA	660	5,4	0,6			•	•	
	600 mA	600	3,1	0,6			•	•	
	700 mA	580	4,5	0,7			•	•	
	800 mA	500	6,4	0,7			•	•	
	1 A	450	13	0,7			•	•	
	1,25 A	400	19	0,7			10.000 A bei / at 125 V	•	•
	1,5 A	370	25	0,8				•	•
	1,6 A	350	32	0,8				•	•
	2 A	330	55	0,9				•	•
	2,5 A	290	90	0,9				•	•
	2,8 A	270	120	1,0				•	•
	3 A	250	160	1,0				•	•
3,2 A	220	350	1,0	•	•				
4 A	200	590	1,1	125 V	•	•			
5 A	200	600	1,3		•	•			
6,25 A	200	1300	1,7		•	•			

Grenzwerte der Schmelzzeit / pre-arcing time limits

Bemessungsstrom rated current	1,1 I _{rat}	1,35 I _{rat}	2 I _{rat}
300 mA ... 3 A	> 4 h	< 1 h	5 s ... 120 s
3,2 A ... 6,25 A			12 s ... 120 s

Gewicht / weight: Art.: 0,1 kg/100

Verpackungseinheit / packing unit: 100 Stück/pcs.

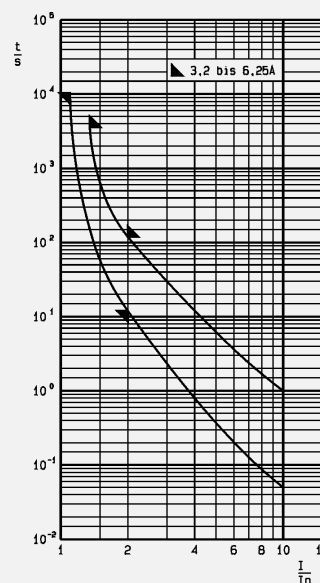
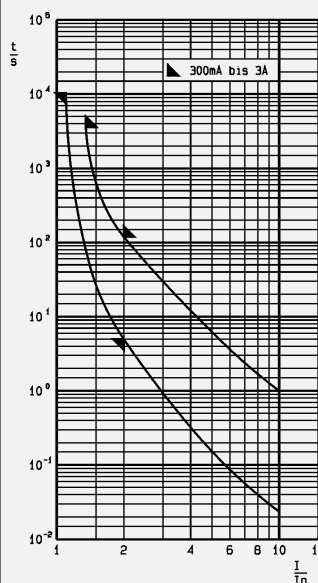

G-Sicherungseinsätze
miniature fuse links

Sonderausführung (nicht genormt)
special type (not standardized)

Keramikrohr (undurchsichtig)
ceramic tube (non-transparent)

FF

superflink
very quick-acting

Approbationen / approvals



verwechselbar
interchangeable

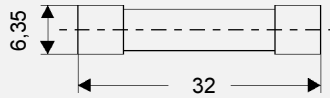

ELU Type
195 100

Art.-Nr.	Bemessungsstrom rated current	max. Spannungsfall max. voltage drop mV	Schmelzintegral I ² t-value A ² s	Total I ² t-Wert total I ² t-value A ² s	Bemessungs- ausschaltvermögen rated breaking capacity	Bemessungs- spannung rated voltage	Approbationen Approvals
70 125 40	160 mA	2000	0,004	0,014	50 kA bei/at AC 700 V cos phi < 0,2	AC 700 V	UL
	200 mA	1600	0,008	0,03			UL
	250 mA	1500	0,024	0,08			UL
	315 mA	1350	0,035	0,12			UL
	400 mA	1030	0,07	0,24			UL
	500 mA	950	0,14	0,48			UL
	630 mA	860	0,14	0,5			UL
	800 mA	760	0,22	0,8			UL
	1 A	1100	0,14	0,5			UL
	1,25 A	1000	0,22	0,8			UL
	1,6 A	900	0,31	1,1	UL		
	2 A	800	0,64	2,2	UL		
	2,5 A	800	1,2	3	UL		
	3,15 A	700	2	5	UL		
	4 A	500	5	13	UL		
	5 A	400	10	25	50 kA bei/at AC 500 V cos phi < 0,2	AC 500 V	UL
	6,3 A*	400	3	14			UL
	8 A*	350	6,5	30			UL
	10 A*	350	12	55			UL
	12,5 A*	300	18	80			UL
16 A*	300	31	140	UL			
20 A*	300	46	200	UL			

* Bei Verwendung dieser G-Sicherungseinsätze ist auf ausreichende Wärmeabfuhr zu achten. / When using this type, consideration should be given to heat dissipation

Grenzwerte der Schmelzzeit / pre-arcing time limits

Bemessungsstrom rated current	1,0 I _{rat}	2,0 I _{rat}	2,75 I _{rat}	4 I _{rat}	10 I _{rat}
160 mA ... 800 mA	> 1 h			< 60 ms	< 6 ms
1 A ... 5 A		15 ms ... 1 s	4 ms ... 100 ms	1 ms ... 25 ms	< 5 ms

Bemessungsstrom rated current	1,2 I _{rat}	1,5 I _{rat}	2,75 I _{rat}	4 I _{rat}	10 I _{rat}
6,3 A ... 20 A	> 1 h	< 30 min	4 ms ... 300 ms	1 ms ... 30 ms	< 2 ms

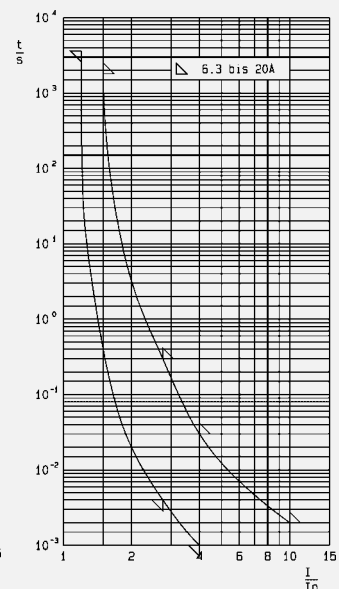
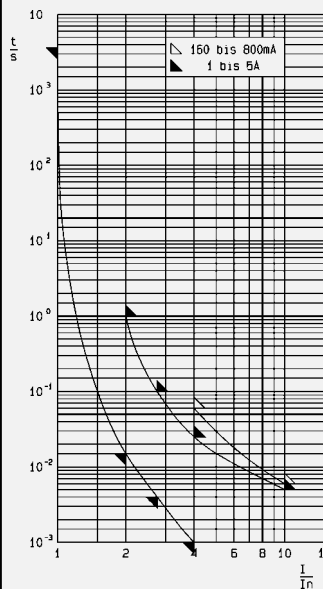

Gewicht / weight: 0,24 kg/100

Verpackungseinheit / packing unit: 100 Stück/pcs.

G-Sicherungseinsätze E16

miniature fuse links E16

DIN 41 687

mit Kennmelder / with indicator

Keramikrohr (undurchsichtig)
ceramic tube (non-transparent)

M mittelträge
medium time-lag

unverwechselbar
non interchangeable

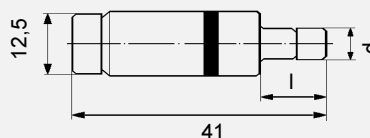

Art.-Nr.	Bemessungsstrom rated current	max. Spannungsfall max. voltage drop mV	Farbe colour	d mm	l	Bemessungs- ausschaltvermögen rated breaking capacity	Bemessungs- spannung rated voltage
10 001 11	500 mA	500	weiß / white	6		G I 1500 A bei / at 250 V 50 Hz	250 V
	1 A	350	rot / red	8	11		
	1,6 A	400	orange / orange	10			
	2 A	600	blau / blue	6			
	4 A	240	braun / brown	8	7		
	6,3 A	250	grün / green	10			
	10 A	200	rot / red	12			

Grenzwerte der Schmelzzeit / pre-arcing time limits

Bemessungs- strom rated current	$1,5 I_{rat}$	$2,1 I_{rat}$	$4 I_{rat}$	$10 I_{rat}$
500 mA ... 1,6 A	> 1 h	< 1 h	0,15 s ... 2 s	15 ms ... 100 ms
2 A ... 10 A			0,3 s ... 3 s	

Gewicht / weight: 1,34 kg/100

Verpackungseinheit / packing unit: 25 Stück/pcs.

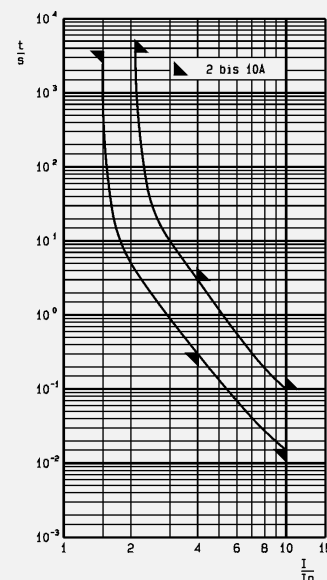
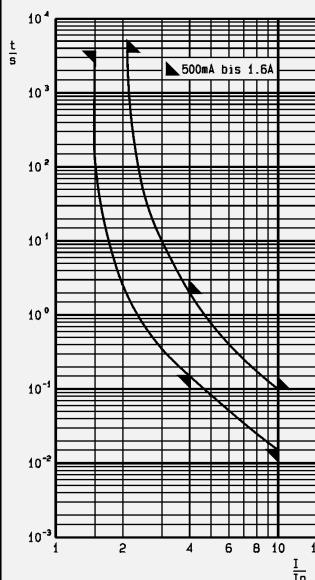

G-Sicherungseinsätze
miniature fuse links

DIN 41 572

mit Kontaktmesser / with knife-contacts

Glasrohr
glass tube

mit teilweise abgedecktem Schmelzleiter
with partly covered fusing element

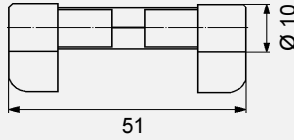

Art.-Nr.	Bemessungsstrom rated current	max. Spannungsfall max. voltage drop mV	Bemessungs- ausschaltvermögen rated breaking capacity	Bemessungs- spannung rated voltage
70 019 08	500 mA	auf Anfrage on request	G I 1500 A bei / at 60 V 50 Hz	60 V
	800 mA			
	1 A			
	1,6 A			
	2 A			
	2,5 A			
	3 A			
	4 A			
6,3 A				

Grenzwerte der Schmelzzeit / pre-arcing time limits

Bemessungs- strom rated current	1,5 I _{rat}	2,1 I _{rat}	4 I _{rat}	10 I _{rat}
0,5 A ... 6,3 A	> 1 h	< 30 min.	< 0,4 s	< 30 ms

Gewicht / weight: 1,1 kg/100

Verpackungseinheit / packing unit: 100 Stück/pcs.

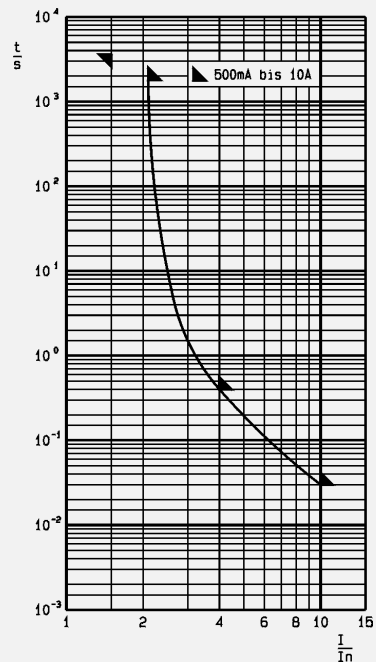

G-Sicherungseinsätze
miniature fuse links

DIN 41 576 T.2

mit Kennmelder / with indicator

Keramikrohr (undurchsichtig)
ceramic tube (non-transparent)

M mittelträge
medium time-lag

verwechselbar
interchangeable

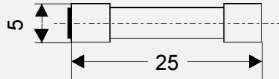

Art.-Nr.	Bemessungsstrom rated current	max. Spannungsfall max. voltage drop mV	Kennmelderfarbe colour code	Bemessungs- ausschaltvermögen rated breaking capacity	Bemessungs- spannung rated voltage
70 011 05	80 mA	520	grau / grey	C _I 80 A bei / at 250 V 50 Hz	250 V
	100 mA	500	rot / red		
	125 mA	500	violett / lilac		
	160 mA	400	orange / orange		
	200 mA	400	blau / blue		
	250 mA	375	gelb / yellow		
	315 mA	410	schwarz / black		
70 010 05	400 mA	280	braun / brown	G _I 1500 A bei / at 250 V 50 Hz	250 V
	500 mA	250	weiß / white		
	630 mA	220	grün / green		
	800 mA	400	grau / grey		
	1 A	350	rot / red		
	1,25 A	315	violett / lilac		
	1,6 A	480	orange / orange		
	2 A	360	blau / blue		
	2,5 A	300	gelb / yellow		
	3,15 A	250	schwarz / black		
	4 A	180	braun / brown		
	5 A	180	weiß / white		
	6,3 A	160	grün / green		
(8 A)	150	grau / grey			
(10 A)	150	rot / red			

(...) nicht genormt / not standardized

Grenzwerte der Schmelzzeit / pre-arcing time limits

Bemessungs- strom rated current	1,5 I _{rat}	2,1 I _{rat}	4 I _{rat}	10 I _{rat}
80 mA ... 100 mA	> 1 h	< 2 min.	0,04 s ... 0,5 s	5 ms ... 30 ms
125 mA ... 1,25 A			0,06 s ... 2 s	5 ms ... 70 ms
1,6 A ... 6,3 A	< 30 min.			

Gewicht / weight: 0,15 kg/100

Verpackungseinheit / packing unit: 100 Stück/pcs.

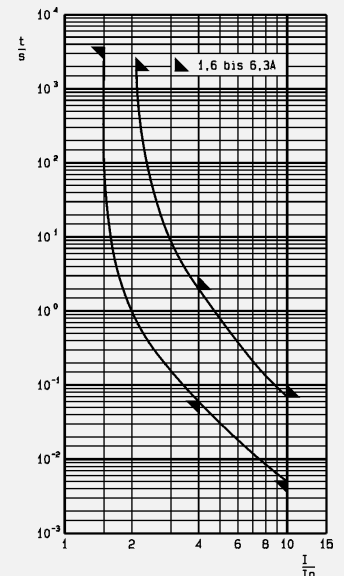
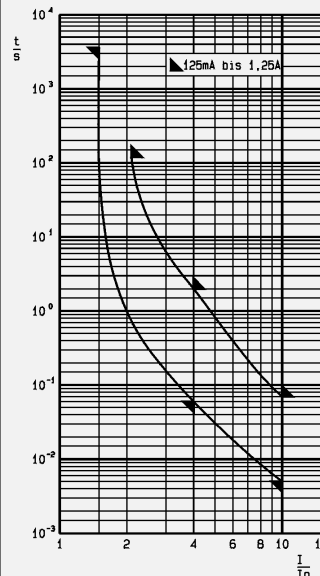

DIN 41 577 T.2

G-Sicherungseinsätze
miniature fuse links

mit Kennmelder / with indicator

Keramikrohr (undurchsichtig)
ceramic tube (non-transparent)

unverwechselbar
non interchangeable

M mittelträge
medium time-lag

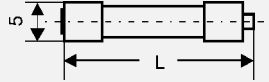

Art.-Nr.	Bemessungsstrom rated current	max. Spannungsfall max. voltage drop mV	L (mm)	Bemessungs- ausschaltvermögen rated breaking capacity	Bemessungs- spannung rated voltage
70 016 07	80 mA	520	25	C _I 80 A bei / at 250 V 50 Hz	
	100 mA	500			
	125 mA	500			
	160 mA	400			
	200 mA	400			
70 017 07	250 mA	500	25	G _I 1500 bei / at A 250 V 50 Hz	250 V
	315 mA	470			
	400 mA	400			
	500 mA	400			
	630 mA	380			
70 014 07	800 mA	400	20		
	1 A	350			
	1,25 A	310			
	1,6 A	480			
	2 A	360			
	2,5 A (3,15 A)	300			
70 012 05	4 A	180			
	6,3 A ¹⁾	160			

(...) nicht genormt / not standardized

¹⁾ ohne Paßzapfen / without fitting device

Grenzwerte der Schmelzeit / pre-arcing time limits

Bemessungs- strom rated current	1,5 I _{rat}	2,1 I _{rat}	4 I _{rat}	10 I _{rat}
80 mA ... 100 mA	> 1 h	< 2 min.	0,04 s ... 0,5 s	5 ms ... 30 ms
125 mA ... 630 mA			0,06 s ... 2 s	5 ms ... 70 ms
800 mA ... 4 A		< 30 min.		

Gewicht / weight: 0,15 kg/100

Verpackungseinheit / packing unit: 100 Stück/pcs.

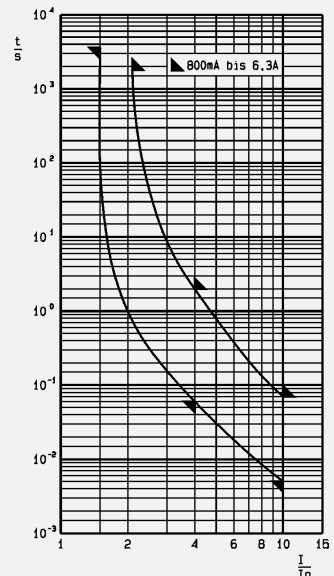
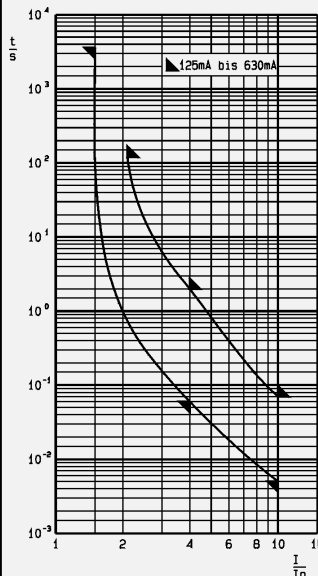

G-Sicherungseinsätze
miniature fuse links

DIN 41 576 T. 1

mit Kennmelder / with indicator

Keramikrohr (undurchsichtig)
ceramic tube (non-transparent)

F flink
quick-acting

verwechselbar
interchangeable

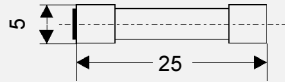

Art.-Nr.	Bemessungsstrom rated current	max. Spannungsfall max. voltage drop mV	Kennmelderfarbe colour code	Bemessungs- ausschaltvermögen rated breaking capacity	Bemessungs- spannung rated voltage
70 010 04	1,6 A	640	orange / orange	G I 1500 A bei / at 250 V 50 Hz	250 V
	2 A	420	blau / blue		
	2,5 A	320	gelb / yellow		
	3,15 A	250	schwarz / black		
	4 A	200	braun / brown		
	5 A	180	weiß / white		
	6,3 A	170	grün / green		
	(8 A)	150	grau / grey		
	(10 A)	120	rot / red		

(...) nicht genormt / not standardized

Grenzwerte der Schmelzzeit / pre-arcing time limits

Bemessungs- strom rated current	$1,5 I_{rat}$	$2,1 I_{rat}$	$4 I_{rat}$	$10 I_{rat}$
1,6 A ... 6,3 A	> 1 h	< 30 min.	< 0,3 s	< 20 ms

Gewicht / weight: 0,13 kg/100

Verpackungseinheit / packing unit: 100 Stück/pcs.

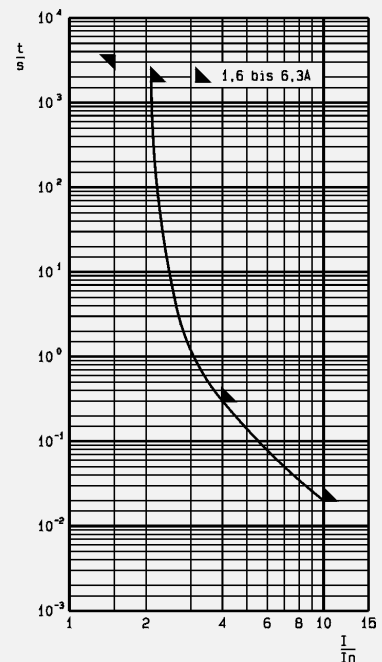

G-Sicherungseinsätze
miniature fuse links

Lloyds genehmigt
Lloyds approved

mit Kennmelder / with indicator

Keramikrohr (undurchsichtig)
ceramic tube (non-transparent)

F flink
quick-acting

verwendbar für Weidmüller-SAKS 1 Klemmen
suitable for Weidmüller-SAKS 1 terminals

verwechselbar
interchangeable

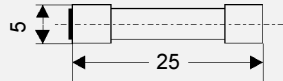

Art.-Nr.	Bemessungsstrom rated current	max. Spannungsfall max. voltage drop mV	Kennmelderfarbe colour code	Bemessungs- ausschaltvermögen rated breaking capacity	Bemessungs- spannung rated voltage
70 089 13	500 mA	700	weiß / white	70 kA bei / at 500 V 50 Hz	450 V
	1 A	300	rot / red		
	1,25 A	250	violett / lilac		
	1,6 A	400	orange / orange		
	2 A	400	blau / blue		
	2,5 A	350	gelb / yellow		
	3,15 A	300	schwarz / black		
	4 A	200	braun / brown		
	6,3 A	150	grün / green		
	10 A	130	rot / red		

Vermerk: Geeignete Aufbausicherungshalter Art.-Nr. 71 044 03 und Schraubkappe Art.-Nr. 72 044 02 siehe Liste M

Note: Suitable fuse-holder for panel mounting part-no. 71 044 03 and screw-cap part-no. 72 044 02 see catalogue M

Grenzwerte der Schmelzzeit / pre-arcing time limits

Bemessungsstrom rated current	1,5 I _{rat}	1,9 I _{rat}	2,1 I _{rat}	5 I _{rat}	7 I _{rat}
500 mA ... 4 A	> 1 h	-	< 1 h	< 0,05 s	-
6,3 + 10 A	< 1 h	-	-	-	< 0,1 s

Gewicht / weight: 0,13 kg/100

Verpackungseinheit / packing unit: 100 Stück/pcs.

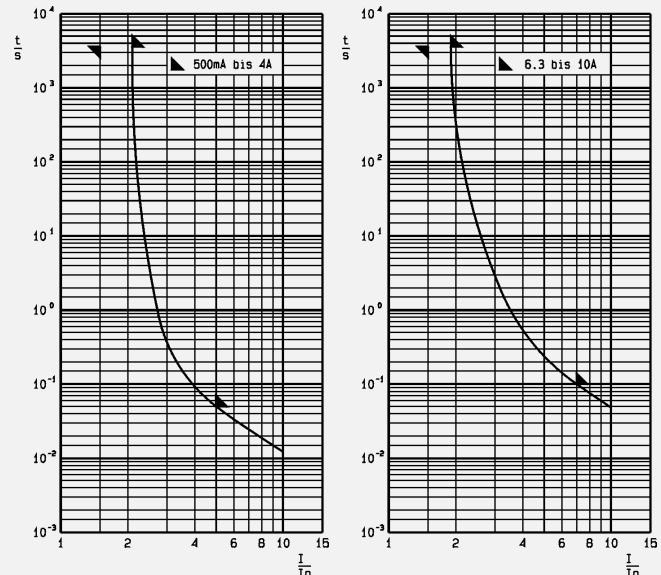

G-Sicherungseinsätze
miniature fuse links

Sonderausführung
Special Type

Glasrohr (durchsichtig) bis 1,25 A
Glasrohr (mit Löschmittelfüllung) ab 1,6 A
glass tube (transparent) up to 1,25 A
glass tube (with filling) from 1,6 A

F flink
quick-acting

M mittelträge
medium time-lag

verwechselbar
interchangeable

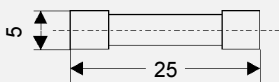

Art.-Nr.	Bemessungsstrom rated current	Bemessungs- ausschaltvermögen rated breaking capacity	Art.-Nr.	Bemessungs- ausschaltvermögen rated breaking capacity	Bemessungs- spannung rated voltage
----------	----------------------------------	---	----------	---	--

Art.-Nr.	Bemessungsstrom rated current	Bemessungs- ausschaltvermögen rated breaking capacity	Art.-Nr.	Bemessungs- ausschaltvermögen rated breaking capacity	Bemessungs- spannung rated voltage
F 70 002 34	32 mA	50 A	M 70 002 02	50 A	250 V
	50 mA				
	63 mA				
	80 mA				
	100 mA				
	125 mA				
	160 mA				
	200 mA				
	250 mA				
	315 mA				
	400 mA				
	500 mA				
	630 mA				
	800 mA				
M	1 A	80 A	M 70 005 02	80 A	250 V
	1,25 A				
	1,6 A				
	2 A				
	2,5 A				
	3,15 A				
	4 A				
	5 A				
	6,3 A				
	8 A				
10 A					

Grenzwerte der Schmelzeit / pre-arcing time limits

Bemessungs- strom rated current	$1,5 I_{rat}$	$2,75 I_{rat}$	$4 I_{rat}$	$10 I_{rat}$
F 32 mA ... 10 A	> 1 h	< 100 s	< 600 ms	< 80 ms
M 32 mA ... 10 A		100 ms ... 20 s	20 ms ... 2 s	5 ms ... 100 ms

Gewicht / weight: 0,12 kg/100

Verpackungseinheit / packing unit: 100 Stück/pcs.

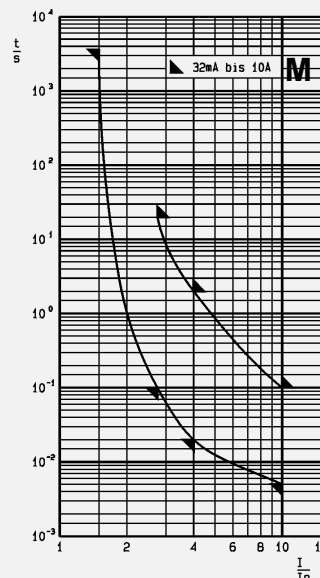
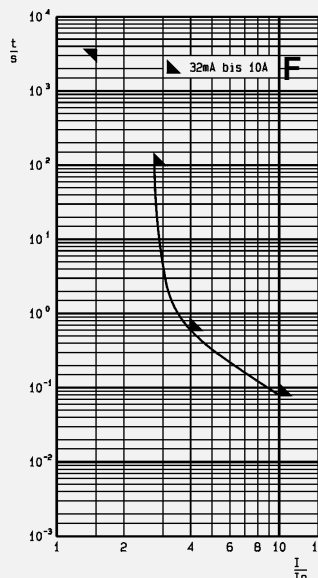

G-Sicherungseinsätze
miniature fuse links

Sonderausführung
Special Type

Glasrohr (durchsichtig) bis 1,25 A
Glasrohr (mit Löschmittelfüllung) ab 1,6 A
glass tube (transparent) up to 1,25 A
glass tube (with filling) from 1,6 A

F

flik
quick-acting

M

mittelträge
medium time-lag

verwechselbar
interchangeable

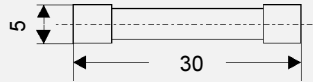

Art.-Nr.	Bemessungsstrom rated current	Bemessungs-ausschaltvermögen rated breaking capacity	Art.-Nr.	Bemessungs-ausschaltvermögen rated breaking capacity	Bemessungs-spannung rated voltage
----------	----------------------------------	---	----------	---	--------------------------------------

F	32 mA	50 A	70 003 02	50 A	500 V
	50 mA				
	63 mA				
	80 mA				
	100 mA				
	125 mA				
	160 mA				
	200 mA				
	250 mA				
	315 mA				
	400 mA				
	500 mA				
	630 mA				
	800 mA				
70 003 34	1 A	80 A	70 006 02	80 A	500 V
	1,25 A				
	1,6 A				
	2 A				
	2,5 A				
	3,15 A				
	4 A				
	5 A				
	6,3 A				
	8 A				
10 A					

Grenzwerte der Schmelzeit / pre-arcing time limits

Bemessungsstrom rated current	$1,5 I_{rat}$	$2,75 I_{rat}$	$4 I_{rat}$	$10 I_{rat}$
F 32 mA ... 10 A	> 1 h	< 100 s	< 600 ms	< 80 ms
M 32 mA ... 10 A		50 ms ... 30 s	20 ms ... 2 s	5 ms ... 100 ms

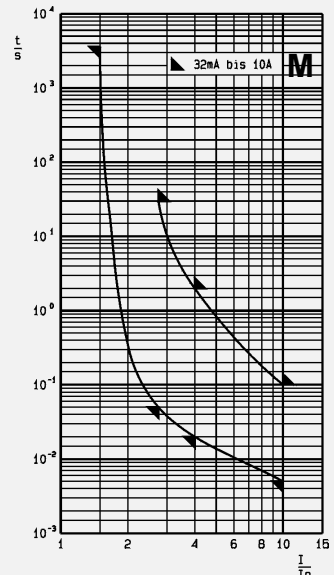
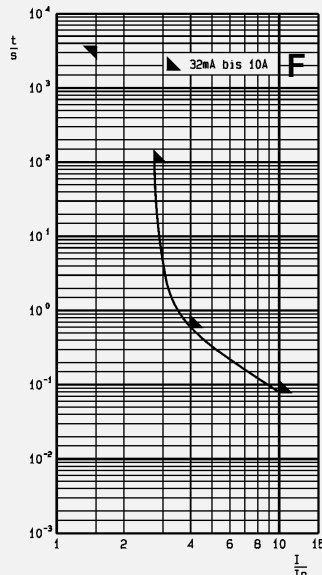

Gewicht / weight: 0,12 kg/100

Verpackungseinheit / packing unit: 100 Stück/pcs.

Hochspannungs-G-Sicherungseinsätze
high voltage miniature fuse links

DIN 41 570

1,2 kV

Glasrohr (durchsichtig) bis 100 mA
Keramikrohr (undurchsichtig) ab 125 mA
glass tube (transparent) up to 100 mA
ceramic tube (non-transparent) from 125 mA

verwechselbar
interchangeable

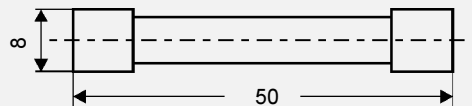

Art.-Nr.	Bemessungsstrom rated current	max. Spannungsfall max. voltage drop mV	Bemessungs- ausschaltvermögen rated breaking capacity	Bemessungs- spannung rated voltage
70 032 09	32 mA	2300	35 A	1200 V
	50 mA	1900		
	63 mA	1700		
	80 mA	1500		
	100 mA	1300		
70 034 09	125 mA	9500		
	160 mA	8000		
	200 mA	7000		
	250 mA	6000		
	315 mA	5000		
	400 mA	2000		
	500 mA	950		
	630 mA	860		
	800 mA	760		
	1 A	640		
	1,25 A	540		
	1,6 A	500		
	2 A	460		
	(2,5 A)			
	(3,15 A)			
(4 A)				
(5 A)				
(6,3 A)				

(...) nicht genormt / not standardized

Grenzwerte der Schmelzeit / pre-arcing time limits

Bemessungs- strom rated current	1,5 I _{rat}	2,1 I _{rat}	4 I _{rat}	10 I _{rat}
32 mA ... 100 mA	> 1 h	< 30 min.	< 0,5 s	< 30 ms
125 mA ... 6,3 A			< 0,3 s	< 20 ms

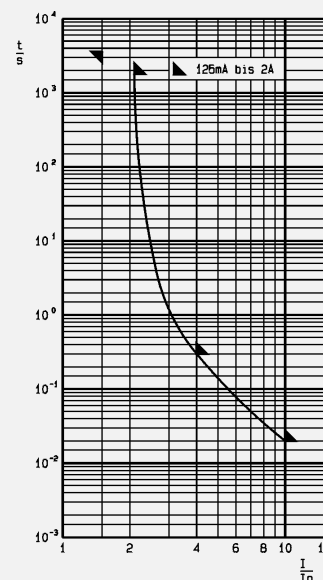
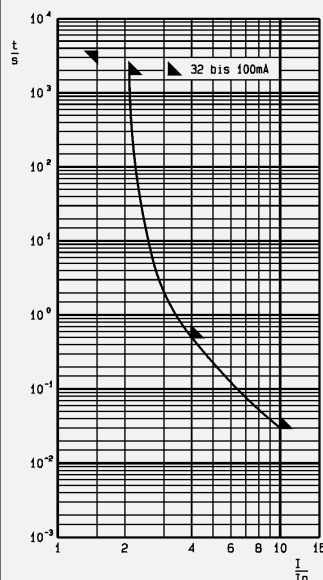

Gewicht / weight: Artikel-Nr. : 70 032 09 = 0,35 kg/100
70 034 09 = 0,68 kg/100

Verpackungseinheit / packing unit: 50 Stück/pcs.

Hochspannungs-G-Sicherungseinsätze
high voltage miniature fuse links

DIN 41 569

3 kV

Glasrohr (durchsichtig) bis 100 mA
Keramikrohr (undurchsichtig) ab 125 mA
glass tube (transparent) up to 100 mA
ceramic tube (non-transparent) from 125 mA

verwechselbar
interchangeable

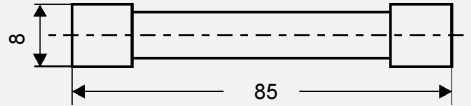

Art.-Nr.	Bemessungsstrom rated current	max. Spannungsfall max. voltage drop mV	Bemessungs- ausschaltvermögen rated breaking capacity	Bemessungs- spannung rated voltage
70 035 09	32 mA	4500	35 A	3000 V
	50 mA	3000		
	63 mA	2400		
	80 mA	1900		
	100 mA	1500		
	125 mA	17000		
70 037 09	160 mA	14000		
	200 mA	12000		
	250 mA	10500		
	315 mA	9000		
	400 mA	3500		
	500 mA	1600		
	630 mA	1500		
	800 mA	1300		
	1 A	1200		
	1,25 A	1000		
	1,6 A	900		
	2 A	800		
(2,5 A)				
(3,15 A)				
(4 A)				

(...) nicht genormt / not standardized

Grenzwerte der Schmelzzeit / pre-arcing time limits

Bemessungs- strom rated current	1,5 I _{rat}	2,1 I _{rat}	4 I _{rat}	10 I _{rat}
32 mA ... 100 mA	> 1 h	< 30 min.	< 0,5 s	< 30 ms
125 mA ... 4 A			< 0,3 s	< 20 ms

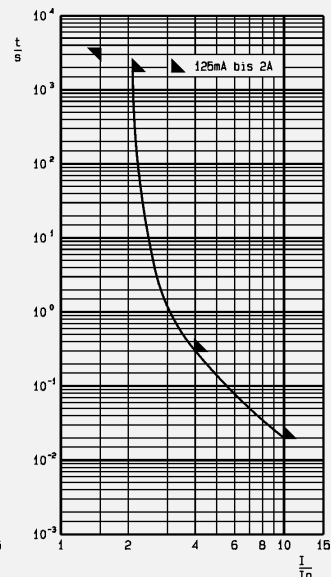
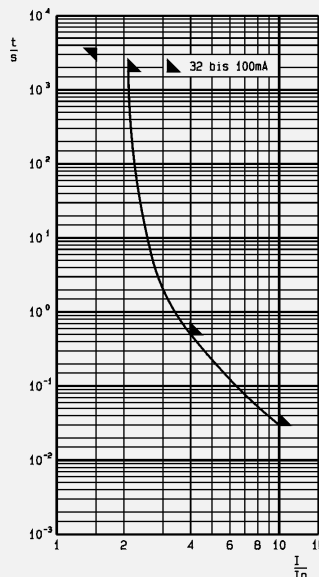

Gewicht / weight: Artikel-Nr. : 70 035 09 = 0,43 kg/100
70 037 09 = 0,84 kg/100

Verpackungseinheit / packing unit: 50 Stück/
pcs.

Hochspannungs-G-Sicherungseinsätze
high voltage miniature fuse links

3 kV

Keramikrohr (undurchsichtig)
ceramic tube (non-transparent)

verwechselbar
interchangeable

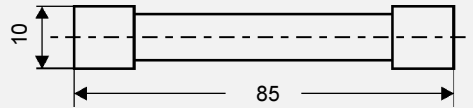

Art.-Nr.	Bemessungsstrom rated current	max. Spannungsfall max. voltage drop mV	Bemessungs- ausschaltvermögen rated breaking capacity	Bemessungs- spannung rated voltage
70 115 09	125 mA	17000	auf Anfrage on request	3000 V
	160 mA	14000		
	200 mA	12000		
	250 mA	10500		
	315 mA	9000		
	400 mA	3500		
	500 mA	1600		
	630 mA	1500		
	800 mA	1300		
	1 A	1200		
	1,25 A	1000		
	1,6 A	900		
	2 A	800		
	2,5 A			
3,15 A				
4 A				

Grenzwerte der Schmelzeit / pre-arcing time limits

Bemessungs- strom rated current	1,5 I _{rat}	2,1 I _{rat}	4 I _{rat}	10 I _{rat}
125 mA ... 4 A	> 1 h	< 30 min.	< 0,3 s	< 20 ms

Gewicht / weight: 1,4 kg/100

Verpackungseinheit / packing unit: 10 Stück/pcs.

Sicherungshalter hierzu Art.-Nr. 71 037 02
Fuse holder see part no. 71 037 02

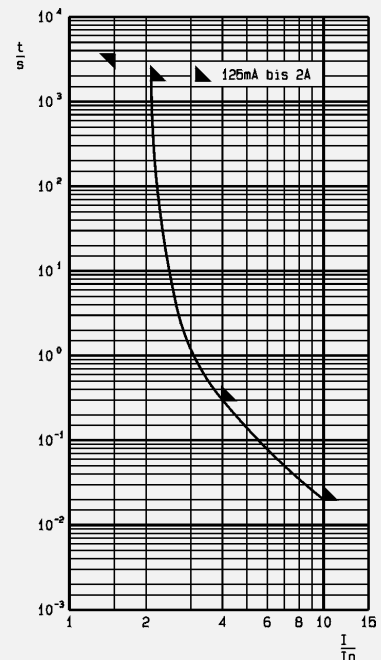

Hochspannungs-G-Sicherungseinsätze
high voltage miniature fuse links

DIN 41 683

6 kV

Glasrohr (durchsichtig) bis 100 mA
Keramikrohr (undurchsichtig) ab 125 mA
glass tube (transparent) up to 100 mA
ceramic tube (non-transparent) from 125 mA

verwechselbar
interchangeable

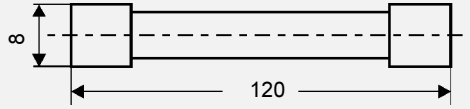

Art.-Nr.	Bemessungsstrom rated current	max. Spannungsfall max. voltage drop mV	Bemessungs- ausschaltvermögen rated breaking capacity	Bemessungs- spannung rated voltage
70 038 10	32 mA	6000	35 A	6000 V
	50 mA	4400		
	63 mA	3800		
	80 mA	3200		
	100 mA	2900		
	125 mA	22000		
	160 mA	19000		
200 mA	16000			
250 mA	14000			
315 mA	12000			
400 mA	5000			
500 mA	2300			
70 040 10	630 mA	2000		
	800 mA	1900		
	1 A	1800		
	1,25 A	1400		
	1,6 A	1300		
	2 A	1100		
	(2,5 A)			
	(3,15 A)			
	(4 A)			

(...) nicht genormt / not standardized

Grenzwerte der Schmelzeit / pre-arcing time limits

Bemessungs- strom rated current	1,5 I _{rat}	2,1 I _{rat}	4 I _{rat}	10 I _{rat}
32 mA ... 100 mA	> 1 h	< 30 min.	< 0,5 s	< 30 ms
125 mA ... 4 A			< 0,3 s	< 20 ms

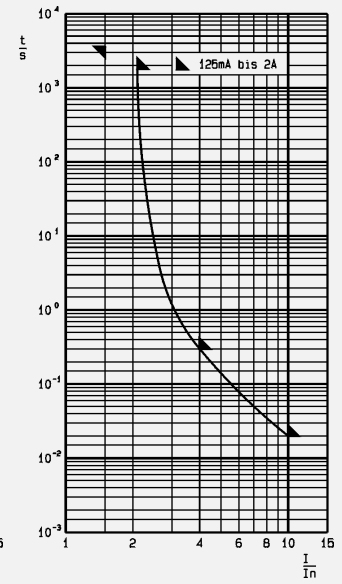
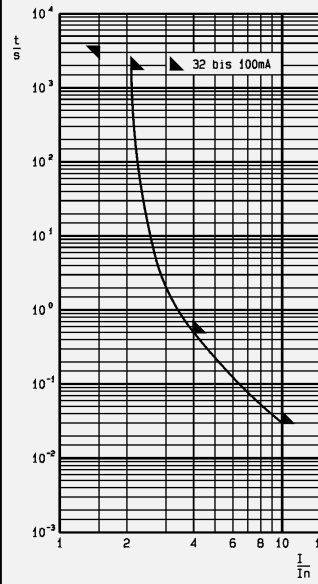

Gewicht / weight: Artikel-Nr. : 70 038 10 = 0,52 kg/100
70 040 10 = 1,00 kg/100

Verpackungseinheit / packing unit: 50 Stück/pcs.

Hochspannungs-G-Sicherungseinsätze
high voltage miniature fuse links

DIN 41 684

10 kV

Glasrohr (durchsichtig) bis 100 mA
Keramicrohr (undurchsichtig) ab 125 mA
glass tube (transparent) up to 100 mA
ceramic tube (non-transparent) from 125 mA

verwechselbar
interchangeable

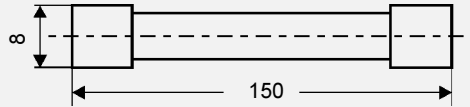

Art.-Nr.	Bemessungsstrom rated current	max. Spannungsfall max. voltage drop mV	Bemessungs- ausschaltvermögen rated breaking capacity	Bemessungs- spannung rated voltage
70 041 10	32 mA	14000	35 A	10000 V
	50 mA	8500		
	63 mA	6500		
	80 mA	5000		
	100 mA	4000		
70 043 10	125 mA	27000		
	160 mA	24000		
	200 mA	21000		
	250 mA	18500		
	315 mA	17000		
	400 mA	6000		
	500 mA	2900		
	630 mA	2700		
	800 mA	2400		
	1 A	2100		
	1,25 A	1800		
	1,6 A	1600		
	2 A	1400		

Grenzwerte der Schmelzzeit / pre-arcing time limits

Bemessungs- strom rated current	1,5 I _{rat}	2,1 I _{rat}	4 I _{rat}	10 I _{rat}
32 mA ... 100 mA	> 1 h	< 30 min.	< 0,5 s	< 30 ms
125 mA ... 2 A			< 0,3 s	< 20 ms

Gewicht / weight: Artikel-Nr. : 70 041 10 = 0,70 kg/100
70 043 10 = 1,30 kg/100

Verpackungseinheit / packing unit: 50 Stück/pcs.

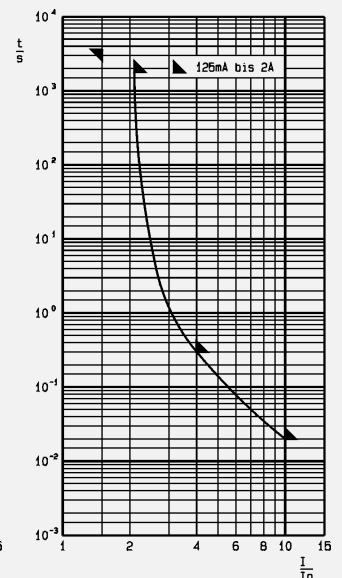
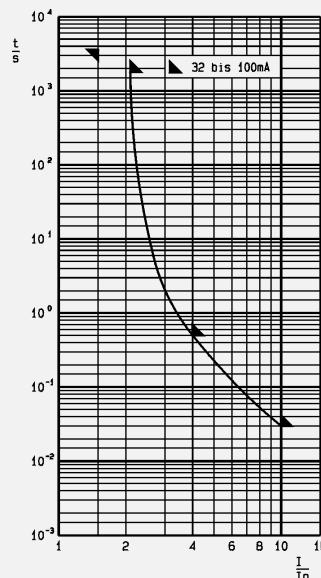

G-Sicherungshalter mit Berührungsschutz
Fuseholder, with contact protection

für G-Sicherungseinsätze 5 x 20 mm
for miniature fuse links 5 x 20 mm

nach / acc. to EN 60127-6, IEC 257, VDE 0820, UL 512, CSA C 22.2-39

Art.-Nr. 71 001 27

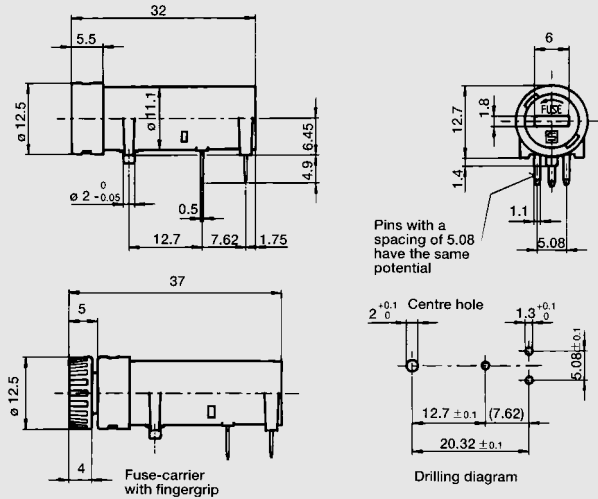

Bemessungsspannung: 250 V
Bemessungsstrom: 10/16 A
Schutzgrad: IP 40

Rated voltage: 250 V
Rated current: 10/16 A
Protection class: IP 40

Montage

Leiterplatte
liegende Ausführung
Stiftabstand 7,62 mm
Bohrungen 1,3 + 0,1 mm Ø

Mounting

printed circuit board
horizontal type
Pin distance 7,62 mm
Hole Ø 1,3 + 0,1 mm

Verschlusskappe

Renkverschlusskappe

Fuse-carrier

bayonet fixing

Anschlüsse

Lötanschlüsse

Connections

solderable

Approbationen / approvals

SEV 10 A / 250 V
VDE 10 A / 250 V
Semko 10 A / 250 V
UL 16 A / 250 V
CSA 16 A / 250 V

Gewicht / weight : 0,55 kg/100

Verpackungseinheit / packing unit : 100 Stück/pcs.

G-Sicherungshalter mit Berührungsschutz
Fuseholder, with contact protection

für G-Sicherungseinsätze 5 x 20 mm und 6,3 x 32 mm
for miniature fuse links 5 x 20 mm and 6,3 x 32 mm

nach / acc. to IEC 257, VDE 0820, UL 512

Art.-Nr. 71 001 14

Art.-Nr. 72 001 08 (5 x 20 mm) 72 001 09 (6,3 x 32 mm)

Bemessungsspannung: 250 V
Bemessungsstrom: 6,3/16 A
Schutzgrad: IP40

Rated voltage: 250 V
Rated current: 6,3/16 A
Protection class: IP40

Montage

Leiterplatte
liegende Ausführung
Stiftabstand 15,24 mm
Bohrungen 1,3 + 0,1 mm Ø

Mounting

printed circuit board
horizontal type
Pin distance 15,24 mm
Hole Ø 1,3 + 0,1 mm

Verschlusskappe

Renkverschlusskappe

Fuse-carrier

bayonet fixing

Anschlüsse

Lötanschlüsse

Connections

solderable

Approbationen / approvals

SEV 6,3 A / 250 V
VDE 10 A / 250 V
Semko 6,3 A / 250 V
UL 16 A / 250 V
CSA 16 A / 250 V

Gewicht / weight : 0,65 kg/100

Verpackungseinheit / packing unit : 100 Stück/pcs.

G-Sicherungshalter mit Berührungsschutz
Fuseholder, with contact protection

für G-Sicherungseinsätze 5 x 20 mm
for miniature fuse links 5 x 20 mm

nach / acc. to EN 60127-6, IEC 257, VDE 0820, UL 512, CSA C 22.2-39

Art.-Nr. 71 001 28

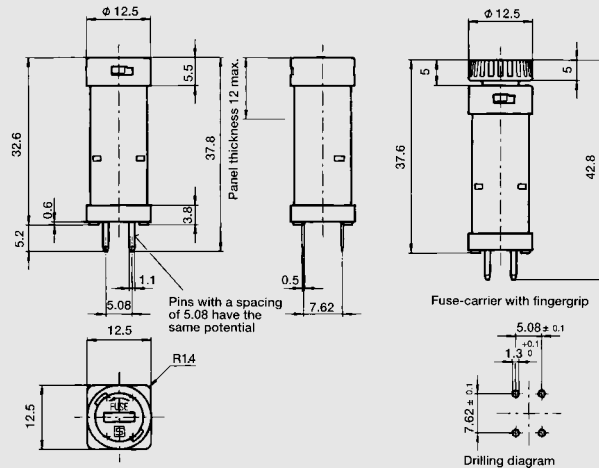

Bemessungsspannung: 250 V
Bemessungsstrom: 10/16 A
Schutzgrad: IP40

Rated voltage: 250 V
Rated current: 10/16 A
Protection class: IP 40

Montage

Leiterplatte
stehende Ausführung
Stiftabstand 7,62 mm
Bohrungen 1,3 + 0,1 mm Ø

Mounting

printed circuit board
vertical type
Pin distance 7,62 mm
Hole Ø 1,3 + 0,1 mm

Verschlusskappe

Renkverschlusskappe

Fuse-carrier

bayonet fixing

Anschlüsse

Lötanschlüsse

Connections

solderable

Approbationen / approvals

SEV 10 A / 250 V
VDE 10 A / 250 V
Semko 10 A / 250 V
UL 16 A / 250 V
CSA 16 A / 250 V

Gewicht / weight : 0,52 kg/100

Verpackungseinheit / packing unit : 100 Stück/pcs.

G-Sicherungshalter mit Berührungsschutz
Fuseholder, with contact protection

für G-Sicherungseinsätze 5 x 20 mm und 6,3 x 32 mm
for miniature fuse links 5 x 20 mm and 6,3 x 32 mm

nach / acc. to IEC 257, VDE 0820, UL 512

Art.-Nr. 71 001 16

Art.-Nr. 72 001 08 (5 x 20 mm)

72 001 09 (6,3 x 32 mm)

Bemessungsspannung: 250 V
Bemessungsstrom: 6,3/16 A
Schutzgrad: IP40

Rated voltage: 250 V
Rated current: 6,3/16 A
Protection class: IP40

Montage

Leiterplatte
stehende Ausführung
Stiftabstand 10 mm
Bohrungen 1,3 + 0,1 mm Ø

Mounting

printed circuit board
vertical type
Pin distance 10 mm
Hole Ø 1,3 + 0,1 mm

Verschlusskappe

Renkverschlusskappe

Fuse-carrier

bayonet fixing

Anschlüsse

Lötanschlüsse

Connections

solderable

Approbationen / approvals

SEV 6,3 A / 250 V
VDE 10 A / 250 V
Semko 6,3 A / 250 V
UL 16 A / 250 V
CSA 16 A / 250 V

Gewicht / weight : 0,75 kg/100

Verpackungseinheit / packing unit : 100 Stück/pcs.

G-Sicherungshalter mit Berührungsschutz
Fuseholder, with contact protection

für G-Sicherungseinsätze 5 x 20 mm
for miniature fuse links 5 x 20 mm

nach / acc. to EN 60127-6, IEC 257, VDE 0820, UL 512, CSA C 22.2-39

Art.-Nr. 71 001 29

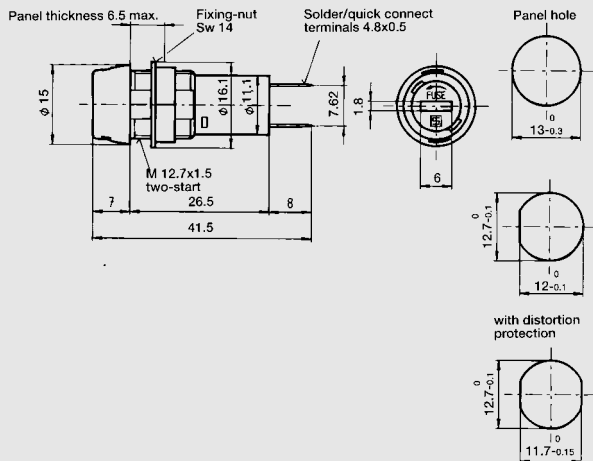

Bemessungsspannung: 250 V
Bemessungsstrom: 10/16 A
Schutzgrad: IP40

Rated voltage: 250 V
Rated current: 10/16 A
Protection class: IP 40

Montage

Frontplatte
Loch - Ø 13 mm
Verdrehungsschutz
Gegenmutter M12,7x1,5

Mounting

Panel
Hole Ø 13 mm
distortion protection
locknut M12,7x1,5

Verschlusskappe

Renkverschlusskappe

Fuse-carrier

bayonet fixing

Anschlüsse

Lötanschlüsse

Connections

solderable

Approbationen / approvals

SEV 10 A / 250 V
VDE 10 A / 250 V
Semko 10 A / 250 V
UL 16 A / 250 V
CSA 16 A / 250 V

Gewicht / weight : 0,54 kg/100

Verpackungseinheit / packing unit : 100 Stück/pcs.

G-Sicherungshalter mit Berührungsschutz
Fuseholder, with contact protection

für G-Sicherungseinsätze 5 x 20 mm und 6,3 x 32 mm
for miniature fuse links 5 x 20 mm and 6,3 x 32 mm

nach / acc. to IEC 257, VDE 0820, UL 512

Art.-Nr. 71 001 23

Art.-Nr. 72 001 08 (5 x 20 mm)

72 001 09 (6,3 x 32 mm)

Bemessungsspannung: 250 V
Bemessungsstrom: 6,3/20 A
Schutzgrad: IP40

Rated voltage: 250 V
Rated current: 6,3/20 A
Protection class: IP 40

Montage

Frontplatte
Loch - Ø 13 mm
Verdrehungsschutz
Gegenmutter M12,7x1,5

Mounting

Panel
Hole Ø 13 mm
distortion protection
locknut M12,7x1,5

Verschlusskappe

Renkverschlusskappe

Fuse-carrier

bayonet fixing

Anschlüsse

Lötanschlüsse

Connections

solderable

Approbationen / approvals

SEV 10 A / 250 V
VDE 10 A / 250 V
Semko 6,3 A / 250 V
UL 12 A / 250 V -
20 A / 250 V
CSA 16 A / 250 V
Australia SEC 16 A / 250 V

Gewicht / weight : 0,54 kg/100

Verpackungseinheit / packing unit : 100 Stück/pcs.

G-Sicherungshalter mit Berührungsschutz
Fuseholder, with contact protection

für G-Sicherungseinsätze 5 x 20 mm und 6,3 x 32 mm
for miniature fuse links 5 x 20 mm and 6,3 x 32 mm

nach / acc. to IEC 257, VDE 0820, UL 512

Art.-Nr. 71 001 24

Art.-Nr. 72 001 08 (5 x 20 mm) **72 001 09** (6,3 x 32 mm)

Bemessungsspannung: 250 V	Rated voltage: 250 V
Bemessungsstrom: 6,3/20 A	Rated current: 6,3/20 A
Schutzgrad: IP40	Protection class: IP 40

Montage	Mounting
Frontplatte	Panel
Loch - Ø 13 mm	Hole Ø 13 mm
Verdrehungsschutz	distortion protection
Gegenmutter M12,7x1,5	locknut M12,7x1,5

Verschlusskappe	Fuse-carrier
Renkverschlusskappe	bayonet fixing

Anschlüsse	Connections
Lötanschlüsse	solderable

Approbationen / approvals
SEV 10 A / 250 V
VDE 10 A / 250 V
Semko 6,3 A / 250 V
UL 12 A / 250 V -
20 A / 250 V
CSA 16 A / 250 V
Australia SEC 16 A / 250 V

Gewicht / weight : 0,56 kg/100

Verpackungseinheit / packing unit : 100 Stück/pcs.

G-Sicherungshalter ohne Berührungsschutz
Fuseholder, without contact protection

für G-Sicherungseinsätze 5 x 20 mm und 5 x 25 mm
for miniature fuse links 5 x 20 mm and 5 x 25 mm

nach / acc. to DIN 41 673

Art.-Nr. 71 001 10

Art.-Nr. 72 001 05 (5x20 mm) **72 001 06** (5x25 mm)
mit Schauglas / with glass window

Bemessungsspannung: 250 V	Rated voltage: 250 V
Bemessungsstrom: 6,3 A	Rated current: 6,3 A

Montage	Mounting
Frontplatte	Panel
Loch - Ø 11 mm	Loch - Ø 11 mm
Schrauben M2	screws M2 Ø
oder Rundstäbe 2 mm	or round poles 2 mm

Verschlusskappe	Fuse-carrier
Schraubkappe	screw-cap

Anschlüsse	Connections
Lötanschlüsse	solderable

Gewicht / weight : 0,58 kg/100

Verpackungseinheit / packing unit : 100 Stück/pcs.

G-Sicherungshalter, offene Bauart
Fuseholder, open type (fuse-blocks)

für G-Sicherungseinsätze 5 x 20 mm
for miniature fuse links 5 x 20 mm

Art.-Nr. 71 001 05

Bemessungsspannung: 250 V Rated voltage: 250 V
Bemessungsstrom: 6,3 A Rated current: 6,3 A

Montage	Mounting
Leiterplatte	printed circuit board
Schrauben oder Nieten	Screw or rivet

Anschlüsse	Connections
Lötanschlüsse	solderable

Gewicht / weight : 0,25 kg/100

Verpackungseinheit / packing unit : 100 Stück/pcs.

G-Sicherungshalter, offene Bauart
Fuseholder, open type (fuse-blocks)

für G-Sicherungseinsätze 5 x 20 mm
for miniature fuse links 5 x 20 mm

Art.-Nr. 71 001 09

Bemessungsspannung: 250 V Rated voltage: 250 V
Bemessungsstrom: 6,3 A Rated current: 6,3 A

Montage	Mounting
Leiterplatte	printed circuit board
Stiftabstand 22,5 mm	Pin distance 22,5 mm
Bohrungen 1,3 + 0,1 mm Ø	Hole Ø 1,3 + 0,1 mm

Anschlüsse	Connections
Lötanschlüsse	solderable

Gewicht / weight : 0,22 kg/100

Verpackungseinheit / packing unit : 100 Stück/pcs.

G-Sicherungshalter, offene Bauart
Fuse-holder, open-type (fuse-blocks)

für G-Sicherungseinsätze 5 x 20 mm
for miniature fuse links 5 x 20 mm

Art.-Nr. 71 001 26

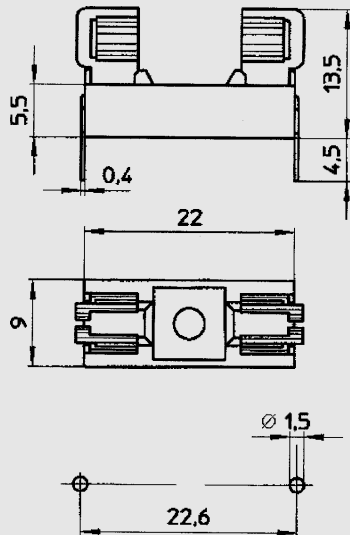

Bemessungsspannung: 250 V
Bemessungsstrom: 6,3 A

Rated voltage: 250 V
Rated current: 6,3 A

Montage

Leiterplatte
Stiftabstand 22,5 mm
Bohrungen 1,5 mm Ø

Mounting

printed circuit board
Pin distance 22,5 mm
Hole Ø 1,5 mm

Anschlüsse

Lötanschlüsse

Connections

solderable

Gewicht / weight : 0,25 kg/100

Verpackungseinheit / packing unit : 100 Stück/pcs.

Abdeckungen (für G-Sicherungshalter Art.-Nr. 71 001 26)
Covers (for fuse-holder part-no. 71 001 26)

Art.-Nr. 73 002 01

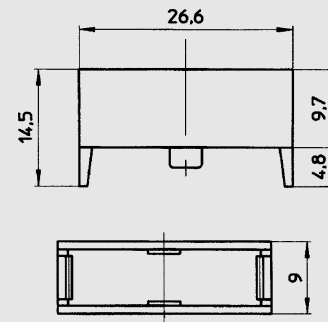

Material

Thermoplast
transparent

Material

Thermoplastic
transparent

Gewicht / weight : 0,18 kg/100

Verpackungseinheit / packing unit : 100 Stück/pcs.

Aufsteckkappen für verwechselbare G-Sicherungseinsätze
Push-on Caps for interchangeable fuse-links

Art.-Nr. 73 001 01 für Sicherungseinsätze Ø 5 mm
for fuse-links Ø 5 mm

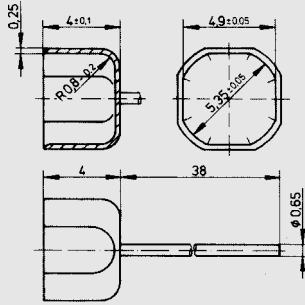

Art.-Nr. 73 001 02 für Sicherungseinsätze Ø 6,3 mm
for fuse-links Ø 6,3 mm

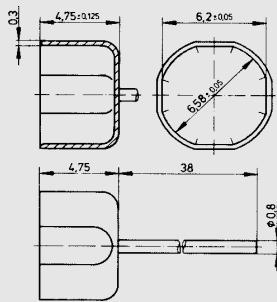

Bemessungsstrom: 6,3 A Rated current: 6,3 A

Montage Mounting
Leiterplatte printed circuit board

Anschlüsse Connections
Axial angeschweißte Drahtenden 38 mm löfbar Axially welded wire ends of 38 mm solderable

Material Material
Kappen Messing versilbert Contact caps brass silver plated
Drähte Kupfer verzinkt Wire ends copper tinned

Gewicht / weight : 0,15 kg/100

Verpackungseinheit / packing unit : 100 Stück/pcs.

G-Sicherungshalter, offene Bauart
Fuseholders, open type

für Kleinstsicherungseinsätze
for sub-miniature fuse-links

Art.-Nr. 71 158 01

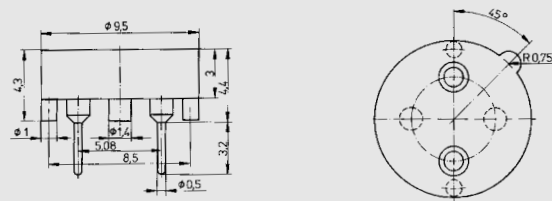

Bemessungs- 250 V Rated voltage: 250 V
spannung: 5 A Rated current: 5 A
Bemessungsstrom:

Montage Mounting
Leiterplatte printed circuit board
Stiftabstand 5,08 mm Pin distance 5,08 mm
Bohrungen 1 mm Ø Hole Ø 1 mm

Anschlüsse Connections
Lötanschlüsse solderable

Gewicht / weight : 0,20 kg/100

Verpackungseinheit / packing unit : 100 Stück/pcs.

G-Sicherungshalter, offene Bauart Fuseholders, open type

für Hochspannungs-G-Sicherungseinsätze
for high voltage miniature fuse links

Art.-Nr.	71 034 01 (1,2 kV)	L = 75 mm	Z = 20 mm
	71 037 01 (3 kV)	L = 110 mm	Z = 20 mm
	71 040 01 (6 kV)	L = 145 mm	Z = 80 mm
	71 043 01 (10 kV)	L = 175 mm	Z = 100 mm

Montage

Leiterplatte oder
Isolierplatte
Schrauben oder Nieten

Mounting

printed circuit board or
insulating plate
Screw or rivet

Anschlüsse

Schraubanschlüsse

Connections

Screw connections

Beim Einbau müssen die Kriech- und Luftstrecken nach VDE 0110 eingehalten werden.
During installation air- and leakage path according to VDE 0110 must be kept.

Gewicht / weight : Art.-Nr.: 71 034 01 1,9 kg/100
71 037 01 2,4 kg/100
71 040 01 2,9 kg/100
71 043 01 3,4 kg/100

Verpackungseinheit / packing unit 15 Stück/pcs. 1,2 kV
20 Stück/pcs. 3, 6 + 10kV

G-Sicherungshalter, offene Bauart Fuse-clips

für G-Sicherungseinsätze Ø 5 mm
for miniature fuse links Ø 5mm

Art.-Nr. 74 001 02

Bemessungsspannung: 500 V max. Rated voltage: 500 V max.
Bemessungsstrom: 6,3 A Rated current: 6,3 A

Montage

Leiterplatte
Stiftabstand 5 mm
Bohrungen 1,3 mm Ø

Mounting

printed circuit board
Pin distance 5 mm
Hole Ø 1,3 mm

Anschlüsse

Lötanschlüsse

Connections

solderable

Gewicht / weight : 0,055 kg/100

Verpackungseinheit / packing unit : 1000 Stück/pcs.

G-Sicherungshalter, geschlossene Bauart
Fuseholders, closed type

für Hochspannungs-G-Sicherungseinsätze 10 x 85 mm
for high voltage miniature fuse links 10 x 85 mm

Art.-Nr. 71 037 02

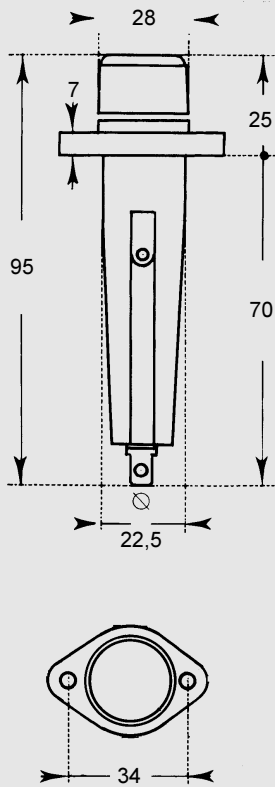

Bemessungsspannung: 3000 V max. Rated voltage: 3000 V max.
Bemessungsstrom: 6,3 A Rated current: 6,3 A

Montage

Frontplatte
Loch - Ø 22,5 mm
Verdrehungsschutz

Mounting

Panel
Hole Ø 22,5 mm
distortion protection

Anschlüsse

Lötanschlüsse und
Steckanschluß 6,35 mm

Connections

solderable and
quick terminal 6,35
mm

Gewicht / weight : 7,5 kg /100

Verpackungseinheit / packing unit 10 Stück/pcs.

Artikel-Nr. Verzeichnis / part-no. index

Art.-Nr./part-no.	Seite/page	Art.-Nr./part-no.	Seite/page
1000111	29	7006565	26
7000102	15	7008913	34
7000134	12	7011509	39
7000135	17	7012540	28
7000140	22	7015902	8
7000176	21	7015972	7
7000179	20	7015973	9
7000202	35	7016002	8
7000234	35	7016072	7
7000302	36	7016073	9
7000334	36	7016102	8
7000401	14	7016172	7
7000402	15	7016173	9
7000403	18	7016271	10
7000502	35	7016276	11
7000602	36	7016371	10
7000702	16	7016376	11
7000733	13	7016471	10
7000740	22	7016476	11
7000765	19	7016974	5
7001004	33	7016975	6
7001005	31	7017074	5
7001105	31	7017075	6
7001205	32	7100105	46
7001407	32	7100109	46
7001607	32	7100110	45
7001707	32	7100114	42
7001908	30	7100116	43
7003209	37	7100123	44
7003409	37	7100124	45
7003509	38	7100126	47
7003709	38	7100127	42
7003810	40	7100128	43
7004010	40	7100129	44
7004110	41	7103401	49
7004310	41	7103701	49
7005960	23	7104001	49
7005961	25	7115801	48
7005976	27	7300101	48
7006563	24	7300102	48
		7300201	47
		7400102	49