



IVO IRION & VOSSELER
 ZÄHLERFABRIK GMBH & CO.
 P.O. BOX 3360
 D-7730 VS-SCHWENNINGEN
 TELEFON: (077 20) 699-1
 TELEX: 794 560
 TELETEX: 772016 = IVOVS
 TELEFAX: 699-212

Product Information

Electro-mechanical impulse counters with or without preset facility F 300

F 300
10.83

177-488 177-490
 177-489 177-491
 177-492

The 300 range includes totalising counters with a facial dimension of 50 x 25 mm, adding and subtracting preset counters, have a facial dimension of 50 x 50 mm. The counters can be used together and be built into a system with our electronic counters and supplementary ranges. Thus counter and control instrumentation for the widest possible field of applications can be built up using this system.

Totalising counters with manual or electrical reset

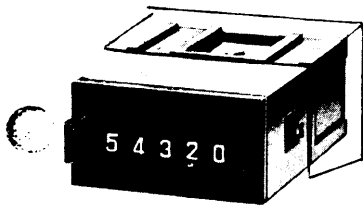

177-491

Specifications

F 304 Plugs into
F 309 socket

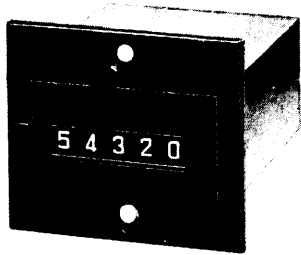

F 304 Plugs into
F 309 panel frame



F 314 Screw
F 319 fixing

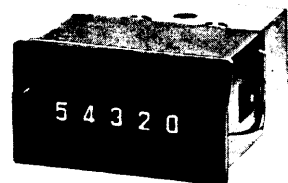

F 324 Spring
F 329 clips

Fixing	Dimensions of Front Panel Width x Depth	No. of Digits	Reset	Model Ref. No.
Plug-in with socket box	50,0 x 25,0 mm	5	Key	F 304.54
		5	Button	F 304.55
		5	Elec. and button	F 309.55
Panel mounting assembly available as an accessory	60,0 x 50,0 mm	6	No reset	F 304.60
		6	Key	F 304.64
		6	Button	F 304.65
		6	Elec. and button	F 309.65
		8	No reset	F 304.80
Front panel for screw fixing	60,0 x 50,0 mm	5	Key	F 314.54
		5	Button	F 314.55
		5	Elec. and button	F 319.55
Front panel for spring clips	53.2 x 28.2 mm	6	No reset	F 314.60
		6	Key	F 314.64
		6	Button	F 314.65
		6	Elec. and button	F 319.65
		8	No reset	F 314.80
Front panel for spring clips	53.2 x 28.2 mm	5	Key	F 324.54
		5	Button	F 324.55
		5	Elec. and button	F 329.55
Front panel for spring clips	53.2 x 28.2 mm	6	No reset	F 324.60
		6	Key	F 324.64
		6	Button	F 324.65
		6	Elec. and button	F 329.65
		8	No reset	F 324.80

Ordering details:

Model and Ref. No. (e.g. F 304.65)
 Voltage and type - AC or DC
 Any special requirements
 Accessories, if required

TECHNICAL SPECIFICATION

Count Mode	One pulse adds one unit in two half stages					
Figures	Approx. 4,5 mm high, white on black ground					
Reset	<p>Manually, by depressing the reset button. The reset button must be depressed to a certain level to operate, which reduces the likelihood of accidental resetting. Counters equipped with a key reset can only be reset by using the special key provided.</p> <p>Electrically, by a reset pulse. While the counter is being reset, no counting pulses can be received.</p>					
Electrical Specification	Max. counting speed	Voltage ± 10 %	Power Rating	Min. length of pulse (millisec.)	Min. pause betw. pulses (millisec.)	Duty Cycle at 25° C
Counting	20 Puls/sec.	6 VDC 12 VDC 24 VDC 48 VDC	2,2 W (4 W)	25 ms	25 ms	100 %
	10 Puls/sec.	24 VAC 110 VAC 220 VAC	2,4 VA (5 VA)	50 ms	50 ms	100 %
Electrical Reset		12 VDC 24 VDC 48 VDC	22 W	250 ms	9 x length of pulse	10 % max. 1 min.
		24 VAC 110 VAC 220 VAC	25 VA	250 ms	9 x length of pulse	10 % max. 1 min.
Power ratings in brackets apply to counters with electrical reset.						
Ripple Factor	DC ≤ 48 %					
Frequency	AC 50 or 60 Hz					
Electrical Connections	<p>Counters with socket box or panel mounting assembly: Silver-plated rectangular contact pins 0,8 x 2,8 mm for push-on or soldered connectors.</p> <p>Counters without socket box: Supplied with silver-plated push-on connectors 1,5 mm dia. for soldering.</p>					
Test voltage	According to VDE 0660					
Life Expectancy	<p>Counting: approx. 10⁸ pulses</p> <p>Resetting: approx. 10⁶ pulses</p>					
Fixing	<p>F 304, F 309 plug into socket box, panel mounting assembly or into socket box with mounting bar. F 314, F 319 with screws.</p> <p>F 324, F 329 with spring clips. Insert the counter from the front through the cutout in the panel, fix the spring clips to the drilled holes at the sides of the counter and tighten them against the mounting panel.</p>					
Protection: (to DIN 40050)	<p>From front (when fitted):</p> <p>Counters without reset facility IP 65</p> <p>Counters with reset facility IP 41</p> <p>By means of a soft, transparent plastic cover IP 55 (see list of accessories).</p>					
Ambient Temperature	0 ... + 45° C					
Casing	High grade plastic.					
Finish	Front panel or cover: matt black					
Weight	Counters with manual reset		approx. 100 g			
	Counters with electrical reset		approx. 170 g			
Options available	1. Red or yellow decimal figures					

Accessories
(see Report Z)

1. Panel mounting assembly with socket box to take plug-in counters
2. Mounting bars to build up a combination of different types of counters.
3. Soft, transparent, plastic covers to protect the counters from dust and moisture.
Can only be used on panel frames or front panels with screw fixings.
4. Panel frame No. 1 for plug-in counters with socket box.

Dimensions

F 304 with
F 309 socket box

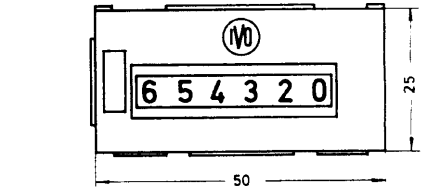
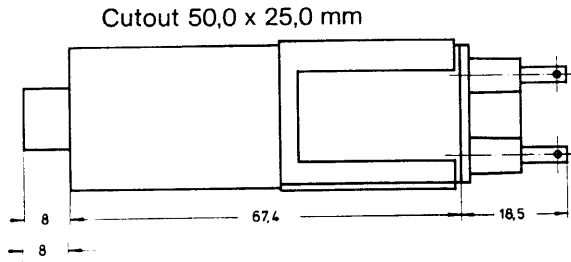

F 304 with panel
F 309 mounting assembly

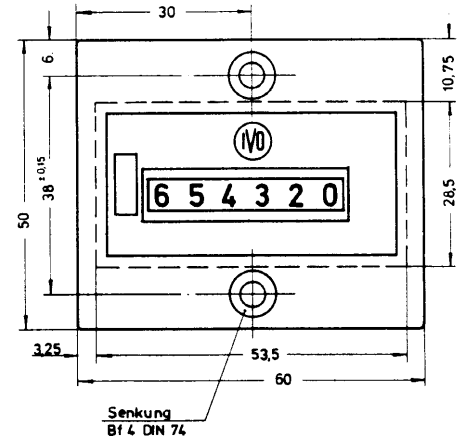
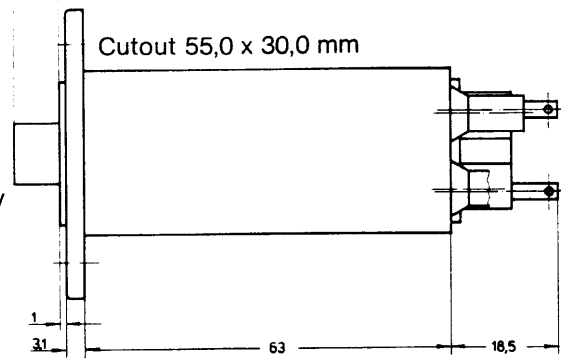

F 314 with
F 319 screw fixing

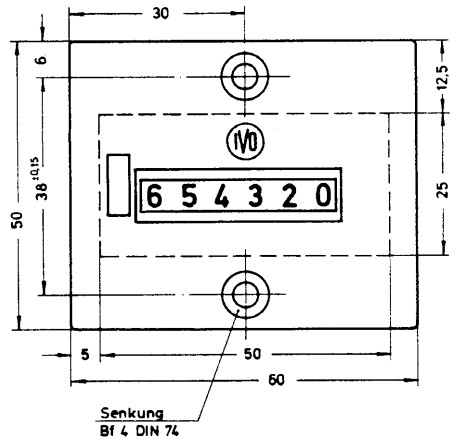
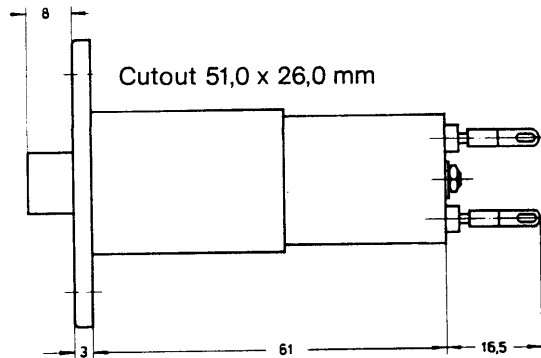

F 324 with
F 329 spring clips

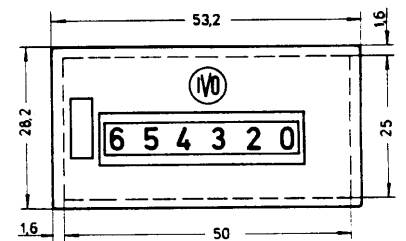
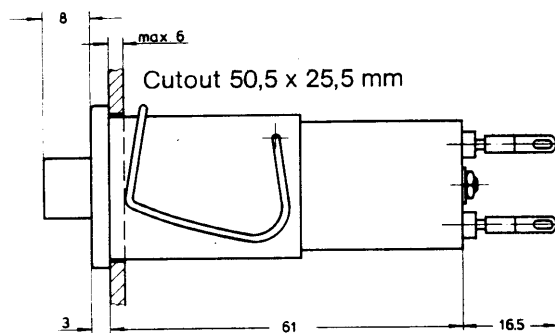

Connection diagrams

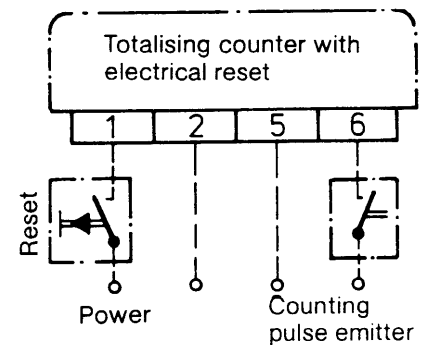
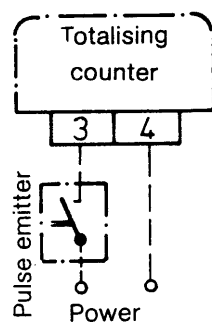

Adding counters with preset facility FE, FW with manual, electrical or automatic reset

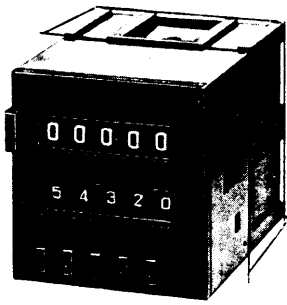

FE 304 plugs into
FE 309 socket box

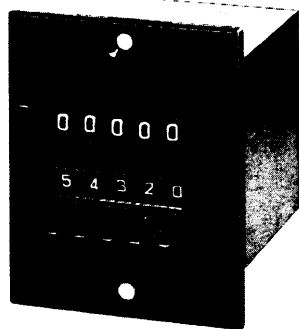

FE 304 plugs into
FE 309 panel mounting assembly

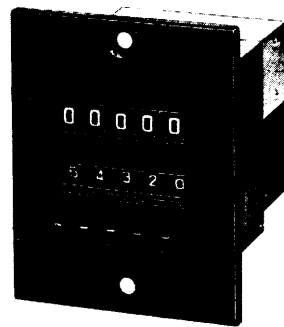

FE 314 with screw
FE 319 fixing

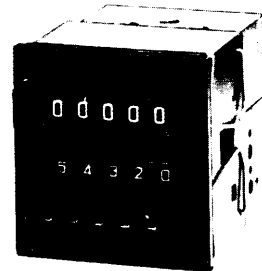

FE 324 with
FE 329 spring clips

Specifications
177-492
Fixing
075-03-050

	Dimensions of Front Panel Width x Depth	No. of Digits	Reset	Model Ref. No.
Plug-in with socket box	50,0 x 50,0 mm	3	Manual	FE 304.35
		5	Manual	FE 304.55
Panel mounting assembly available as an accessory		3	Elec. and manual	FE 309.35
		5	Elec. and manual	FE 309.55
Screw fixing on front panel	60,0 x 75,0 mm	3	Autom. and manual	FW 309.35
		5	Autom. and manual	FW 309.55
Spring clips to front panel	53,2 x 53,2 mm	3	Manual	FE 314.35
		5	Manual	FE 314.55
		3	Elec. and manual	FE 319.35
		5	Elec. and manual	FE 319.55
		3	Autom. and manual	FW 319.35
		5	Autom. and manual	FW 319.55
		3	Manual	FE 324.35
		5	Manual	FE 324.55
		3	Elec. and manual	FE 329.35
		5	Elec. and manual	FE 329.55
		3	Autom. and manual	FW 329.35
		5	Autom. and manual	FW 329.55

Ordering details:

Model and Ref. No. (e.g. FE 319.55)
Voltage and type AC or DC

Options:

Key reset
Accessories
Special requirements

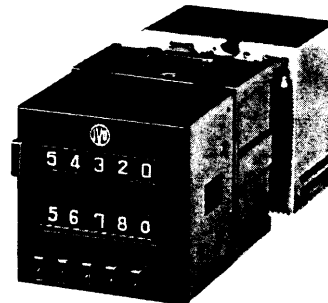

FW 309 with automatic repeat of the preset figure

TECHNICAL DETAILS

Operation The counter counts from zero to the preset figure, when, at the end of the pulse, a changeover contact operates. This changeover contact remains operative until the counter is reset, even if further counting pulses are received.

Count Mode One pulse adds one unit in two half stages.

No. of digits and range
3 digit: 999
5 digit: 99999

Figures
Display: approx. 4,5 mm high, white on black ground
Preset: approx. 3,5 mm high, yellow on black ground

To preset counter Depress the reset button and key in the desired figure. Release the reset button. The preset buttons are then locked, which prevents accidental alteration of the preset figure.

Reset and Repeat **No counting pulses can be received while the counter is being reset.**
When the counter is reset, the display digit wheels return to zero. Simultaneously, the output contact is brought back to its original position and the counter set for the keyed in figure, so that the same counting process is repeated without the counter having to be newly preset.

Manual reset is achieved by pressing the reset button. Counters which are equipped with a key reset can only be reset by using the special key provided.

Manual and electrical reset – operated by an external pulse to the counter.

Manual, electrical and automatic reset – when the counter reaches the preset figure, a changeover contact operates for about 250 milliseconds, and the counter is automatically reset to zero. For the duration of the changeover contact and approx. 100 milliseconds thereafter, no counting pulses should be operated or received. Pulse counting will not be interrupted while the counter is being reset providing that the counting speed is not greater than 1 pulse/second (pulse ratio to pause between pulses = 1 : 2).

If the counting speed is greater, the counting pulses must be interrupted during reset. The maximum number of resets is 1 per 10 seconds for intermittent operation and 1 per minute for continuous operation. For applications requiring more frequent resets, we recommend the use of our electronic counters.

Electrical Specifications	Max. Counting Speed	Voltage ± 10 %	Power	Min. length of pulse (milliseconds)	Min. pause betw. pulses (millisec.)	Duty cycle at 25° C
Counting	20 Puls/sec	6 VDC 12 VDC 24 VDC 48 VDC	2,2 W (4 W)	25 ms	25 ms	100 %
	10 Puls/sec	24 VAC 110 VAC 220 VAC	2,4 VA (5 VA)	50 ms	50 ms	100 %
Electrical Reset		12 VDC 24 VDC* 48 VDC	22 W	250 ms	9 x length of pulse	10 % max. 1 min.
		24 VAC* 110 VAC* 220 VAC*	25 VA	250 ms	9 x length Of pulse	10 % max. 1 min.

Note: Counters with automatic reset are only available in the voltages marked *. Power ratings in brackets apply to counters with electrical reset.

Adding counters with preset facility FE, FW

with manual, electrical or automatic reset

Technical Details, cont.

Ripple Factor DC \leq 48 %
Frequency AC 50 or 60 Hz

Contact Loadings max. 30 W max. 100 VA
 max. 220 V max. 220 V
 max. 1 A max. 2 A
 for DC for AC

Test Voltage according to VDE 0660

Life Expectancy Counting: approx. 10^8 pulses
 Electrical Reset: approx. 10^6 pulses
 The counter is equipped with a standard micro-switch with single pole changeover contact. Its mechanical life is approx. 1 million operations, its electrical life depends on loading. Spark suppression should be provided for inductive loads.

Electrical Connections Counters with socket box or panel mounting assembly and with automatic reset: Silver-plated rectangular contact pins 0,8 x 2,8 mm for soldered contacts or push-on connectors.

Counters without socket box:
 Supplied with silver-plated push-on connectors 1,5 mm dia. for soldering.

Manual Reset Connection Diagrams:

Models FE 304, FE 314, FE 324
 Counting on terminals 3 and 4
 Output contacts on terminals 20, 21, 22

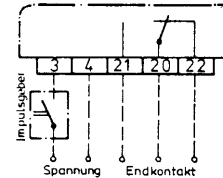

Electrical Reset
 Models FE 309, FE 319, FE 329
 Counting on terminals 5 and 6
 Resetting on terminals 1 and 2
 Final contact on terminals 20, 21, 22

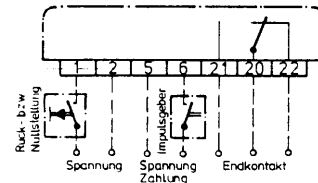

Automatic Reset
 Models FW 309, FW 319, FW 329

1 and 2 Counter controlling number of batches } Power supplied by FW
 3 and 4 Totalising counter
 5 and 6 Power supply
 7 and 8 Pulse emitter (potential free)
 9 and 10 Reset pulses (potential free)
 20, 21 and 22 Output contact

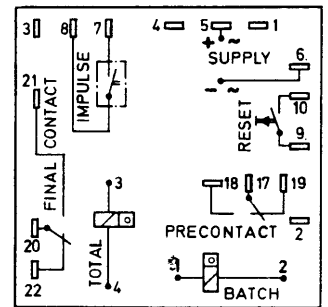

Protection (DIN 40050) From the front, when fitted: IP 41
 with soft, transparent, plastic cover IP 55
 (see accessories)

Ambient Temperature 0 ... + 45° C

Fixing FE 304, FE 309, FW 309
 Plug-in with socket box, or panel mounting assembly or rear mounted into socket box using mounting bar.
 FE 314, FE 319, FW 319
 Fixing by means of two screws
 FE 324, FE 329, FW 329
 Fixing by means of two spring clips. Insert counter from the front through the cutout in the frame. Hook the spring clips into the drilled holes at the sides of the counter and tighten against the panel frame.

Finish Front panel or cover: Matt black plastic

Weight Counters with manual reset: approx. 150 g
 Counters with electrical reset: approx. 230 g
 Counters with automatic reset: approx. 300 g

Accessories (see Report Z)
 1. Panel mounting assembly with adaptors to take plug-in counters
 2. Mounting bars for combining a number of counters with socket boxes.
 3. Soft, transparent, plastic covers to protect the counters against dust and moisture.
 Can only be used with panel frames or front panels with screw fixings.
 4. Panel frame No. 2 for plug-in counters with socket box.

Options available

1. Separate voltage inputs (e.g. to accommodate different supply voltages for counting and resetting).
2. Additional contact at each resetting operation – available on all models in the FE 304 and FE 309 ranges.

Dimensions

**FE 304 with
FE 309 socket box**

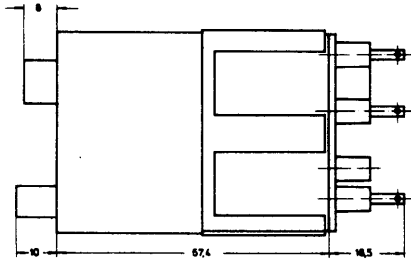

FW 309 Cutout 50,0 x 50,0 mm

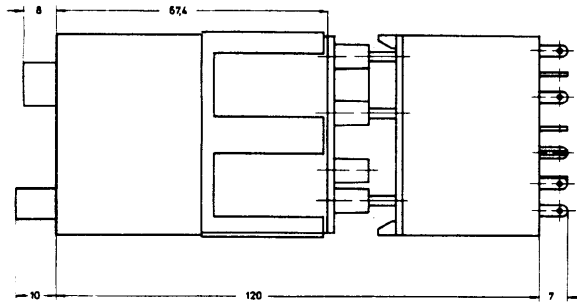

Omitted in 3-digit versions

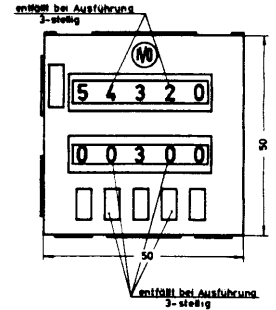

**FE 304 with panel
FE 309 mounting assembly**

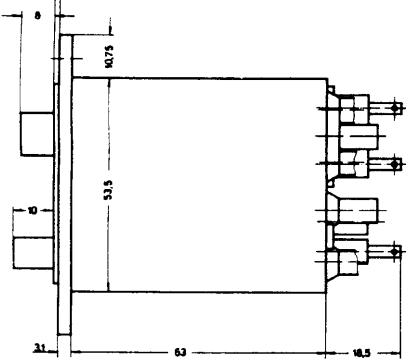

FW 309 Cutout 55,0 x 55,0 mm

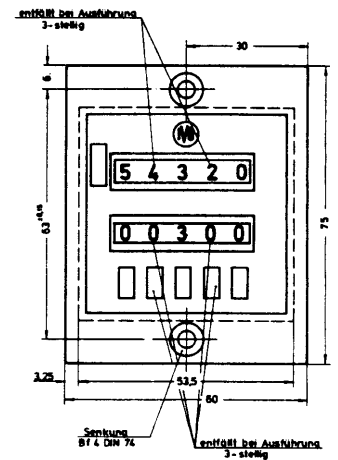
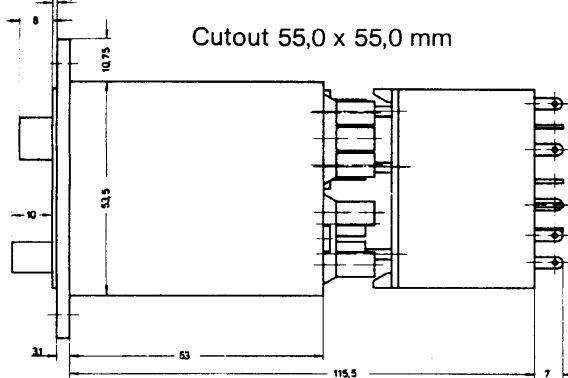

**FE 314
FE 319**

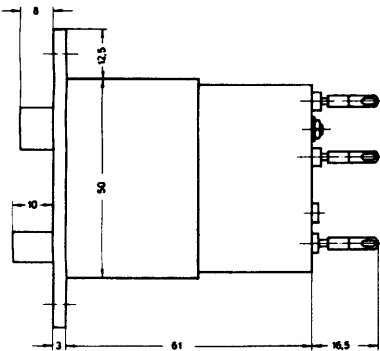

FW 319 Cutout 51,0 x 51,0 mm

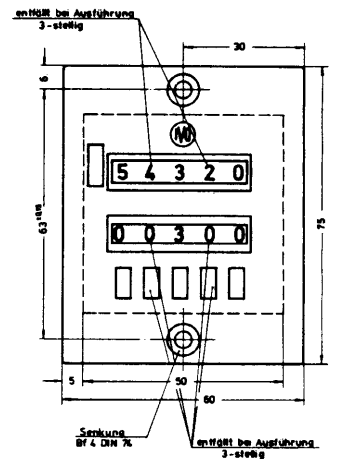
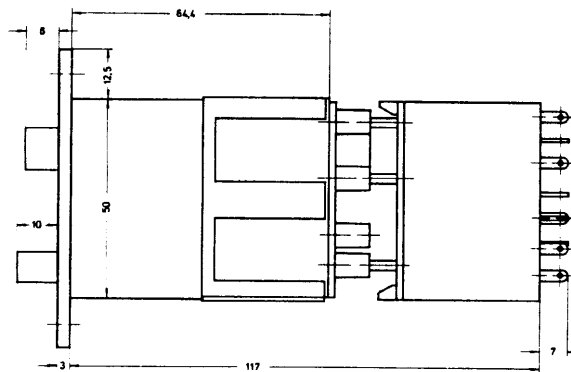

**FE 324
FE 329**

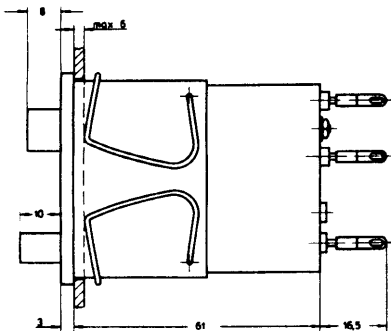

FW 329 Cutout 50,5 x 50,5 mm

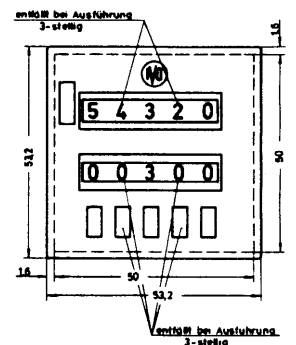
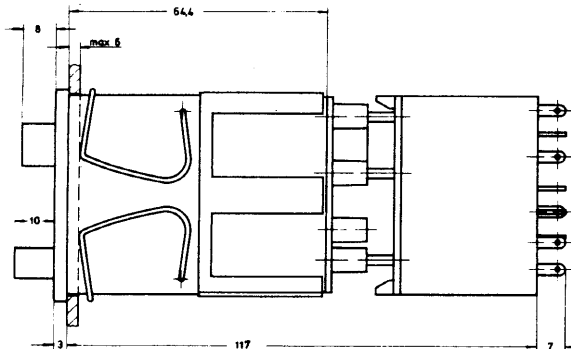

Subtracting counters with preset facility FS, FR

with manual, electrical or automatic reset

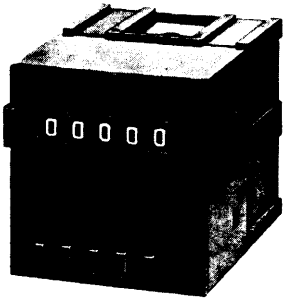

FS 304 plugs into FS 309 socket box

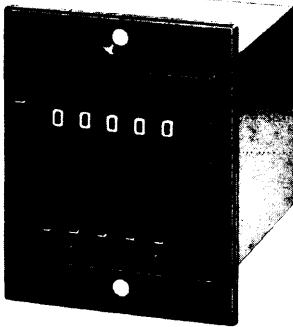

FS 304 plugs into FS 309 panel mounting assembly

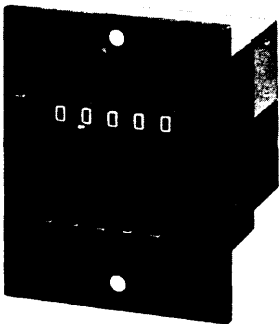

FS 314 with screw FS 319 fixing

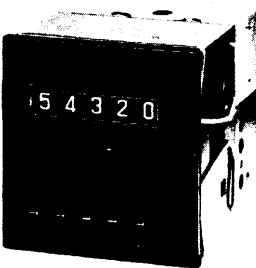

FS 324 with FS 329 Spring clips

Specifications

Fixing	Dimensions of Front Panel Width x Depth	No. of Digits	Reset	Model Ref. No.
Plug-in with socket box	50,0 x 50,0 mm	3	Manual	FS 304.35
		5	Manual	FS 304.55
		3	Elec. and manual	FS 309.35
		5	Elec. and manual	FS 309.55
		3	Autom. and manual	FR 309.35
		5	Autom. and manual	FR 309.55
Screw fixing on front panel	60,0 x 75,0 mm	3	Manual	FS 314.35
		5	Manual	FS 314.55
		3	Elec. and manual	FS 319.35
		5	Elec. and manual	FS 319.55
		3	Autom. and manual	FR 319.35
		5	Autom. and manual	FR 319.55
Spring clips to front panel	53,2 x 53,2 mm	3	Manual	FS 324.35
		5	Manual	FS 324.55
		3	Elec. and manual	FS 329.35
		5	Elec. and manual	FS 329.55
		3	Autom. and manual	FR 329.35
		5	Autom. and manual	FR 329.55

Ordering details

Model and ref. no. (e.g. FS 314.55)
Voltage and type AC or DC
If required: Fixed pre-signal contact at No. ...
Accessories, if required.

Options available:

Key reset
Any special requirements

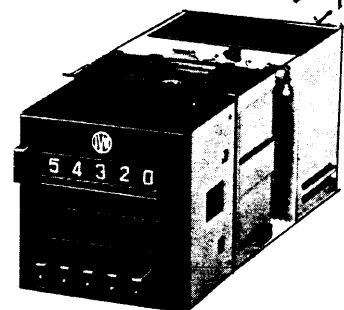

FR 309 with automatic repeat of the preselected figure

TECHNICAL DETAILS

Operation

The counter subtracts from the preset figure, down to zero, and, at the end of the final pulse, releases a changeover contact. This changeover contact remains operative until the counter is reset, even if further pulses are received (FS model).

Count mode

1 pulse subtracts 1 unit in 2 half stages.

Pre-contact

A fixed pre-signal contact can be provided to operate at any fixed number before the final signal. This pre-signal contact is a changeover contact and also remains operative until the counter is reset.

No. of digits and range

3 digit: 999
5 digit: 99999

Figures

approx. 4,5 mm high, white on black ground

Max. Counting speed

20 pulses/second – DC
10 pulses/second – AC

Preselection

Depress reset button and key in the desired figure. Release reset button. The preset buttons are then locked, which prevents accidental alteration of the preset figure.

Reset and Repeat

No counting pulses can be received while the counter is being reset.

When the counter is reset, the display digit wheels are returned to the preselected figure. Simultaneously, the output contact is brought back to its original position, so that the same subtracting process can be repeated without having to preset the counter again.

Manual reset is achieved by pressing the reset button.

Counters equipped with a key reset can only be reset by using the special key provided.

Manual and Electrical Reset is operated by an external pulse to the counter.

Automatic, electrical and manual reset.

When the counter reaches the position 00 000, a changeover contact comes into operation for approx. 250 milliseconds.

Simultaneously, the counter returns to the preset figure. For the duration of the changeover contact and about 100 milliseconds thereafter, no counting pulses should be operated or received.

Pulse counting will not be interrupted while the counter is being reset, provided that the counting (or subtracting) speed is not greater than 1 pulse/second (Pulse ratio to pause between pulses = 1 : 2). If the counting speed is greater, the counting pulses must be interrupted during reset. The maximum number of resets is 1 per 10 seconds for intermittent operation and 1 per minute for continuous operation. For applications requiring more frequent resetting, we recommend our electronic counters.

Electrical Specifications:

	Max. Counting Subtracting Speed	Voltage ± 10 %	Power	Min. length of pulse (millisec.)	Min. pause betw. pulses (millisec.)	Duty Cycle at 25° C
Counting	20 Pulses/sec.	6 VDC 12 VDC 24 VDC 48 VDC	2,2 W (4 W)	25 ms	25 ms	100 %
	10 Pulses/sec.	24 VAC 110 VAC 220 VAC	2,4 VA (5 VA)	50 ms	50 ms	100 %
Electrical Reset		12 VDC 24 VDC* 48 VDC	22 W	250 ms	9 x length of pulse	10 % max. 1 min.
		24 VAC* 110 VAC* 220 VAC*	25 VA	250 ms	9 x length of pulse	10 % max. 1 min.

Note: Counters with automatic reset are only available in the voltages marked *. Power ratings in brackets apply to counters with electrical reset

Subtracting preset counters FS, FR

with manual, electrical or automatic reset

Technical Details, cont.

Ripple Factor DC \leq 48 %
Frequency AC 50 or 60 Hz

Contact Loadings max. 30 W max. 100 VA
 max. 220 V max. 220 V
 max. 1 A max. 2 A
 for DC for AC

Test Voltage according to VDE 0660

Life Expectancy Counting: approx. 10^8 pulses
 Electrical Reset: approx. 10^6 pulses
 The counter is equipped with a standard micro-switch with single-pole changeover contact. Its mechanical life is approx. 1 million operations, its electrical life depends on loading. Spark suppression should be provided for inductive loads.

Electrical Connections Counters with socket box or panel mounting assembly and with automatic reset: Silver-plated rectangular contact pins 0,8 x 2,8 mm for soldered contacts or push-on connectors.

Counters without socket boxes:
 Supplied with silver-plated push-on connectors 1,5 mm dia. for soldering.

Manual reset: Connection diagrams

Models FS 304, FS 314, FS 324
 Counting on terminals 3 and 4
 Precontact on terminals 18, 17, 19
 Final contact on terminals 21, 20, 22

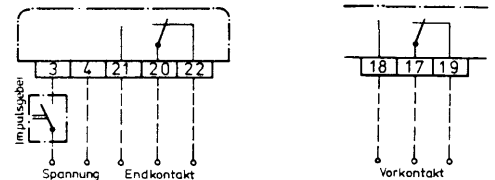

Electrical reset:
 Models FS 309, FS 319, FS 329
 Counting on terminals 5 and 6
 Reset on terminals 1 and 2
 Precontact on terminals 18, 17, 19
 Final contact on terminals 21, 20, 22

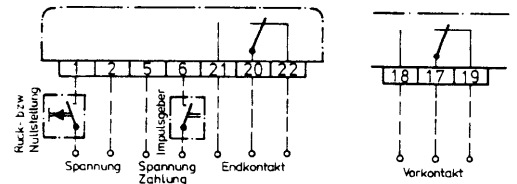

Automatic reset:
 Models FR 309, FR 319, FR 329
 1 and 2 Counter controlling number of batches } Power supplied by FR
 3 and 4 Totalising counter }
 5 and 6 Power supply }
 7 and 8 Pulse emitter (potential free)
 9 and 10 Reset pulse (potential free)
 17, 18, 19 Precontact
 20, 21, 22 Final contact

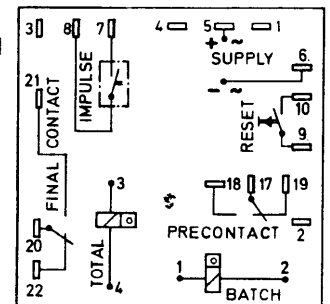

Protection (DIN 40050) From the front, when fitted: IP 41
 with soft, transparent, plastic cover IP 55
 (see accessories)

Ambient Temperature 0 ... + 45° C

Fixing FS 304, FS 309, FR 309 Plug into socket box, push into panel mounting assembly or rear-mounted into socket box by means of mounting bar.
 FS 314, FS 319, FR 319 Fixing by means of two screws
 FS 324, FS 329, FR 329 Fixing by means of two spring clips.
 Insert counter from the front through the cutout in the frame.
 Hook the spring clips onto the drilled holes at the sides of the counter and tighten against the panel.

Finish Front panel or cover: matt black plastic

Weight Counters with manual reset: approx. 150 g
 Counters with electrical reset: approx. 230 g
 Counters with automatic reset: approx. 300 g

Accessories
(see Report Z)

1. Panel mounting assembly with adaptors to take plug-in counters
2. Mounting bars for combining a number of FS 304 counters with socket boxes.
3. Soft, transparent, plastic covers to protect the counters against dust and moisture.
Can only be used on counters with panel frames or front panels for screw fixing.
4. Panel frame No. 2 for plug-in counters with socket box.

Options available

1. Separate voltage inputs e.g. to accommodate different supply voltages for counting and resetting
2. Additional contact at each resetting operation – available on all models in the FS 304 and FS 309 ranges.

FS 304 with FS 309 socket box

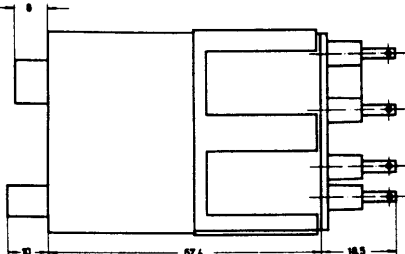

FR 309 Cutout 50,0 x 50,0 mm

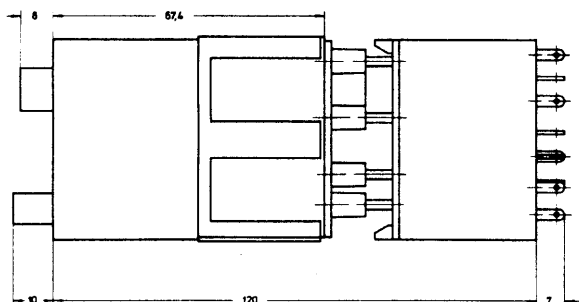

Omitted on 3 digit models

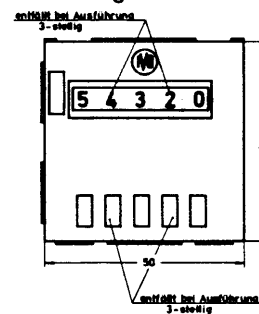

FS 304 Panel mounting FS 309 assembly

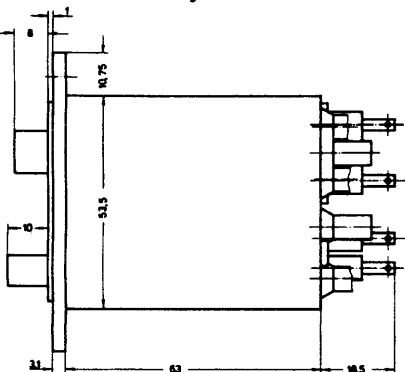

FR 309

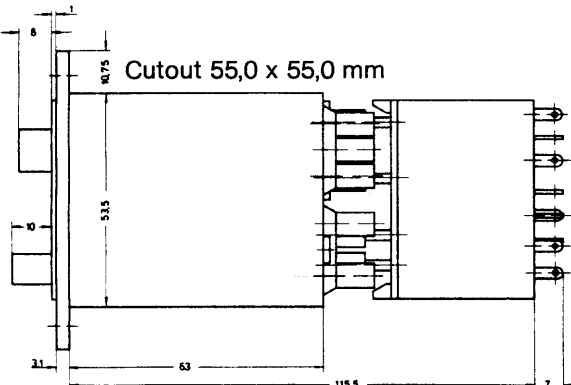

Cutout 55,0 x 55,0 mm

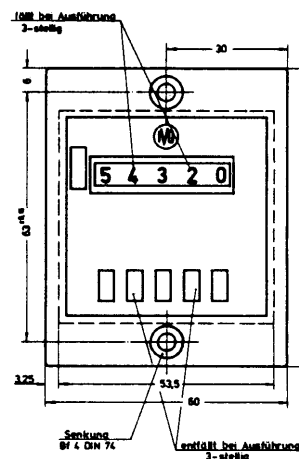

FS 314 FS 319

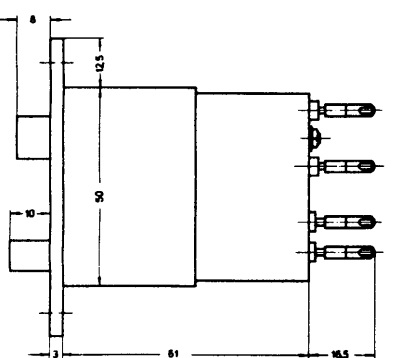

FR 319 Cutout 51,0 x 51,0 mm

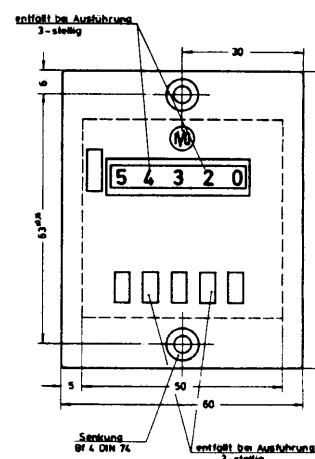
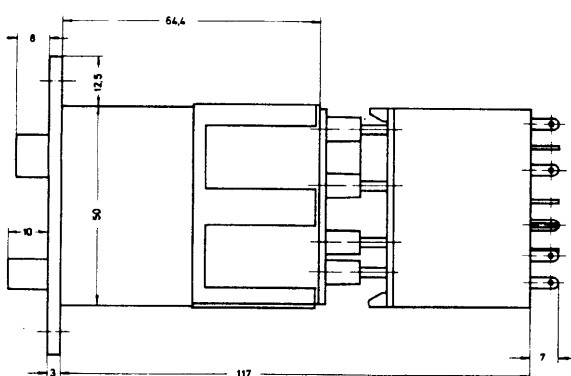

FS 324 FS 329

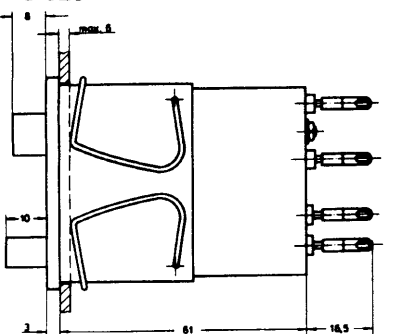

FR 329 Cutout 50,5 x 50,5 mm

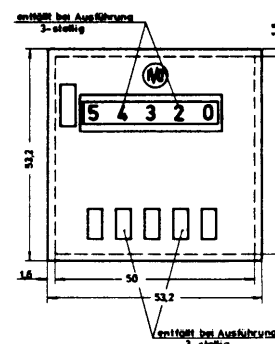
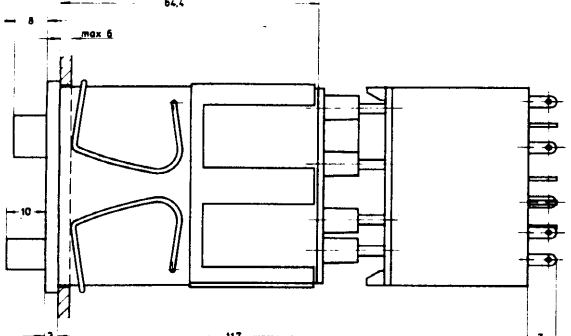

Connection Diagrams
(Examples)

Connection diagram for an FR with precontact, with one voltage input, for AC.

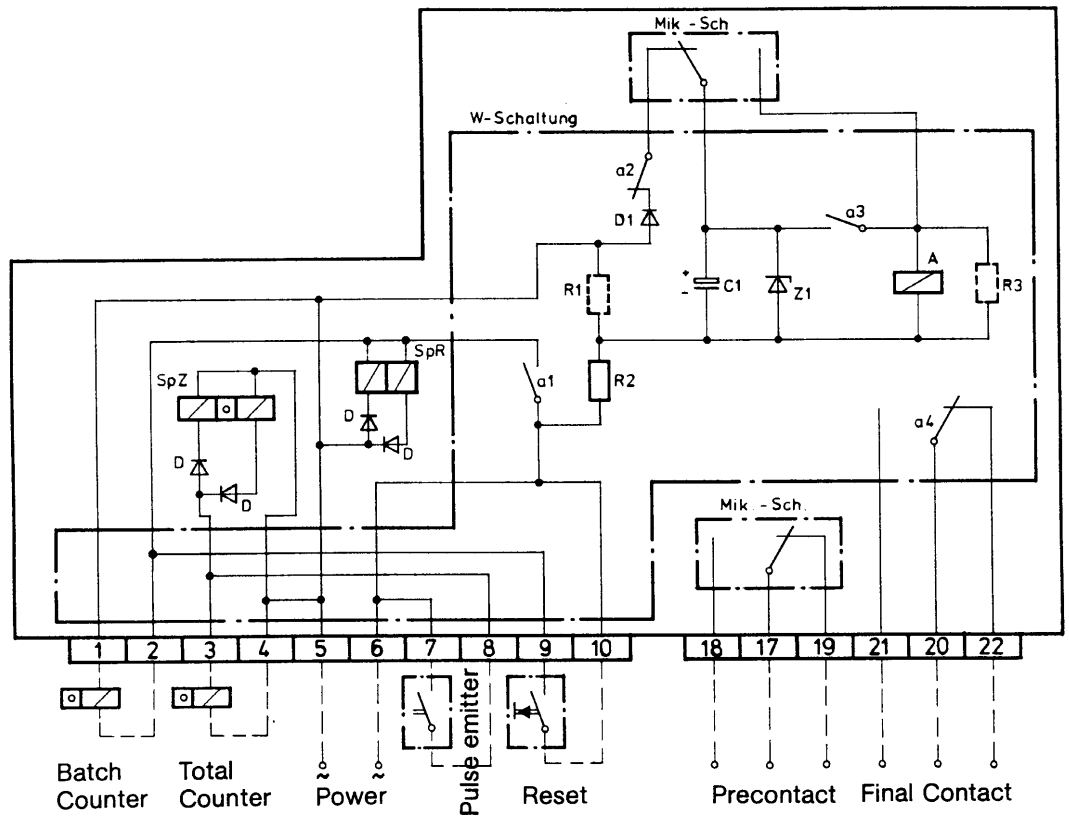

IMPORTANT NOTE

When using the counter for monitoring machines or programming where accidental breakdown of the counter may cause damage to the machine or its operating personnel, additional safety regulations should be introduced. When installing and using the counter, care should be taken to ensure that the relevant rules for the prevention of accidents are observed. The mains voltage has to be positively switched off before interfering with the counter on the machine.

We reserve the right to make alterations without prior notification.