



MINIMET

[Home Page](#)
[E-Mail Us](#)
[Catalogue PDF](#)
[Get a Catalogue](#)
[Get a Drawing](#)
[Get a Price](#)
[Get a Quote](#)
[Customising](#)
[IP Ratings](#)
[Colour Chart](#)
[Ordering Info](#)
[Order Form](#)
 01489 583858

 01489 583836

FEATURES:

- Small aluminium instrument enclosures
- Stylish, light weight and versatile design
- Eight standard sizes
- Simple and fast assembly technique
- Removable base panel pre-fitted with four M3x8mm PCB screw pillars
- Accessory anodised front/rear panels
- Accessory painted front/rear panels
- Front panels are recessed by 8 mm at one end and 14mm at the other end
- Four self-adhesive non-slip feet included

MATERIAL:

- Aluminium

PROTECTION CLASS:

- IP 40 (Not rated)

FINISH:

- Powder epoxy polyester paint

STANDARD COLORS:

- Case - light grey, RAL 7035
- ABS panel trims - window grey, RAL 7040

SUPPLY:

1. Top cover
2. Base panel
3. M3 x 6 mm (x4/6)
4. M3 x 8 mm (x8)
5. Non-slip feet (x4)
6. Front/rear panel kit AN (accessory)
7. Front/rear panel PN (accessory)

ACCESSORIES:

- Front/Rear Panel Kit AN
- Aluminium Front/Rear Panel PN

APPLICATIONS:

- Medical and wellness devices, test and measurement equipment, industrial control, peripheral devices and interfaces, switchboxes, communications and laboratory equipment.

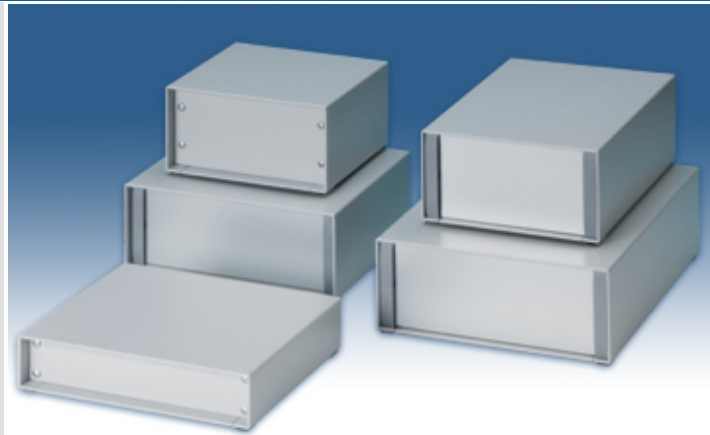

Small Aluminium Instrument Cases



Accessory Front/Rear Panels



Recessed Panels - 2 Depths



Easy Access Base Panels

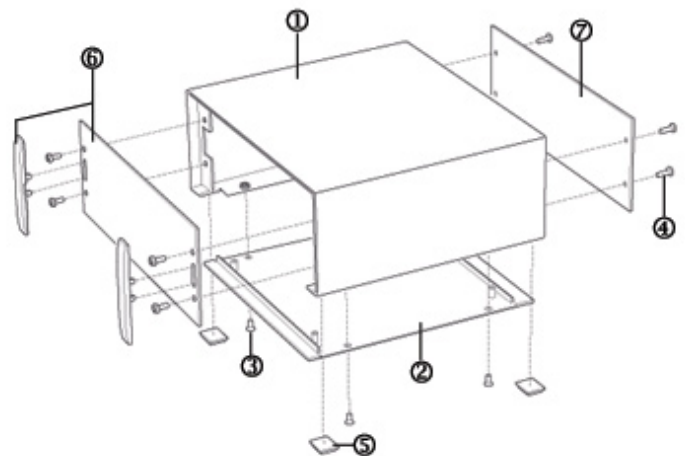

M3 PCB Fixing Pillars

 [Printable Page](#)

MINIMET



Part No.	Description	W	D	H	Drawings
M5113115	£ MINIMET 1	134.5	130	38.5	PDF
M5113125	£ MINIMET 2	134.5	130	70	PDF
M5113215	£ MINIMET 3	134.5	200	38.5	PDF
M5113225	£ MINIMET 4	134.5	200	70	PDF
M5117115	£ MINIMET 5	174.5	160	38.5	PDF
M5117125	£ MINIMET 6	174.5	160	70	PDF
M5117215	£ MINIMET 7	174.5	240	38.5	PDF
M5117225	£ MINIMET 8	174.5	240	70	PDF

DWG

FRONT/REAR PANELS



For..	Part No. Front/Rear Panel Kit AN* (Anodised)	£	Part No. Front/Rear Panel PN* (Painted)	£	Drawings
MINIMET 1	M5100510	£	M5100515	£	PDF
MINIMET 2	M5100520	£	M5100525	£	PDF
MINIMET 3	M5100510	£	M5100515	£	PDF
MINIMET 4	M5100520	£	M5100525	£	PDF
MINIMET 5	M5100550	£	M5100555	£	PDF
MINIMET 6	M5100560	£	M5100565	£	PDF
MINIMET 7	M5100550	£	M5100555	£	PDF
MINIMET 8	M5100560	£	M5100565	£	PDF

DWG

Notes:
 * Front/Rear Panel Kit AN - Anodised aluminium front panel + 2 clip-on ABS trims (fixing screws supplied with case)
 * Front/Rear Panel PN - Aluminium front panel painted light grey, RAL 7035 (fixing screws supplied with case)

[Printable Page](#)



[Customising](#)

FIRST ANGLE PROJECTION

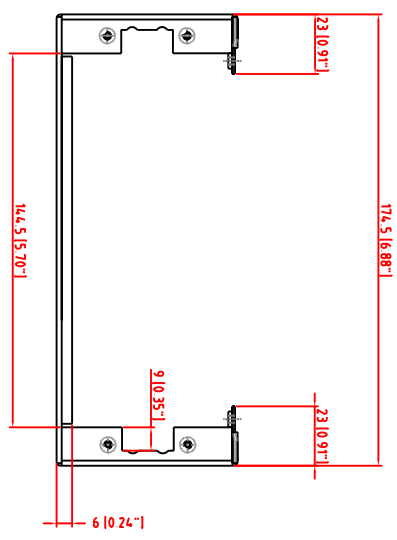

Cover made from 1mm aluminum.

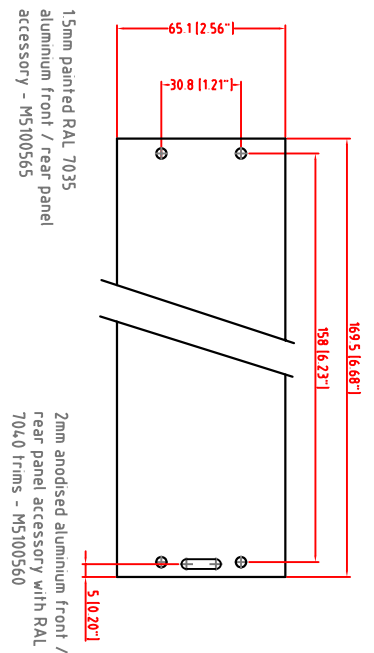
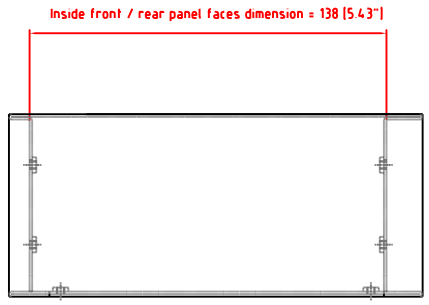
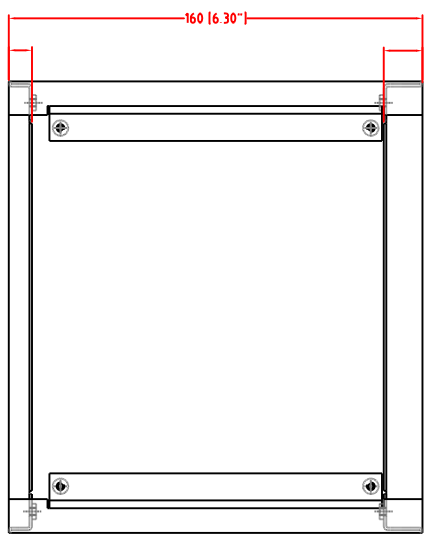

15mm painted RAL 7035 aluminum front / rear panel accessory - M5100565

2mm anodised aluminium front / rear panel accessory with RAL 7040 trim - M5100560

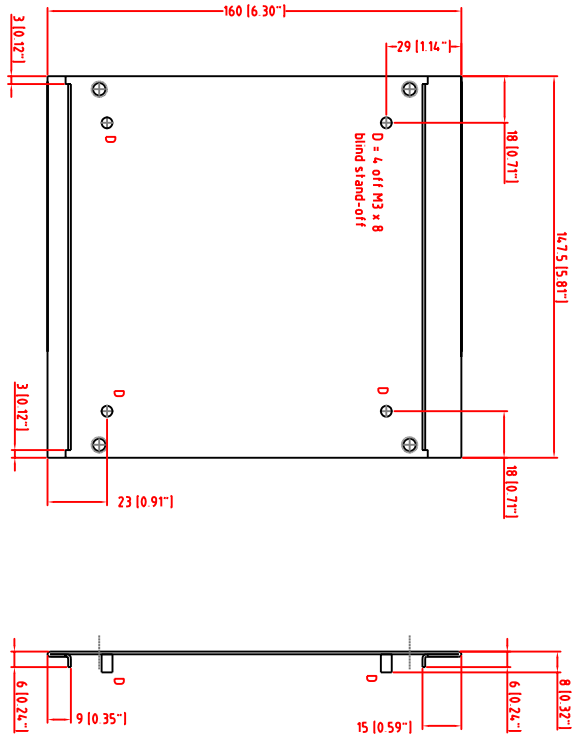

Base made from 1mm aluminum.

Front & rear panels are not included with the standard case. Choose the required type as an accessory - see above.

Note: Subject to technical modifications without prior notice. Typographical and other errors do not justify any claim for damages. All dimensions should be verified using the actual case.

Tolerances unless otherwise stated:
General tolerances: ±0.20
Resultant tolerances between hole centers: ±0.15
Tolerances on hole diameters: ±0.05
Angles: ± 0.5°
Surface finish: 32/

Required finish: Powder paint RAL 7035

Scale: 1:1
Drawn by: Ian Cox
Checked by:
Drawing Number:

Part Name: Minimet 6
Part Number: M5117125

ALL DIMENSIONS IN MILLIMETRES (Inches in brackets)
Date drawn: December '05
Material Spec:
DO NOT SCALE

W.W.W. metcase.com
METCASE ENCLOSURES
Unit 3, Mitchell Close
Segensworth East, Fareham,
Hampshire, PO15 SSE, UK.
©OWW ENCLOSURES LTD DATE AS SHOWN. THIS DRAWING CONTAINS PROPRIETARY INFORMATION OF OWW ENCLOSURES LTD AND IS TENDERED SUBJECT TO THE FOLLOWING CONDITIONS: THE INFORMATION BE RETAINED IN CONFIDENCE, NOT BE REPRODUCED OR COPIED, AND NOT BE USED OR INCORPORATED IN ANY PRODUCT, UNLESS PERMISSION IS OBTAINED IN WRITING FROM OWW ENCLOSURES LTD.
Sheet 1 of 1
A2

Modifications: 155