

AFCT-701ASDZ

10Gb Ethernet, 1310 nm, 10GBASE-LR,

SFP+ Transceiver for SMF 10km links

Case temperature 0-85 °C



Data Sheet



Description

The Avago AFCT-701ASDZ transceiver is part of a family of SFP+ products. This transceiver utilizes Avago's 1310nm DFB and PIN Detector technology to provide an IEEE 10Gb Ethernet design compliant with the 10GBASE-LR standard. The AFCT-701ASDZ transceiver is designed with an extended case temperature to 0-85 °C to enable 10Gb Ethernet equipment designs with very high port density based on the new electrical and mechanical specification enhancements to the well known SFP specifications developed by the SFF Committee. These specifications are referred to as SFP+ to recognize these enhancements to previous SFP specifications used for lower speed products. Avago Technologies is an active participant in the SFF Committee specification development activities.

Related Products

- AFCT-701SDZ SFP+ 10 Gigabit Ethernet 10GBASE-LR transceiver with case temperature operated at 0-70 °C for operation in SMF link applications to 10 km
- AFBR-707SDZ SFP+ 10 Gigabit Ethernet 10GBASE-LRM transceiver for 220 meter operation in all MMF link applications including OM1 and OM2 legacy fiber cables and new high bandwidth OM3 fiber cables.
- The AFBR-703SDZ (AFBR-703ASDZ) with case temperature 0-70 (0-85) °C is an SFP+ 10 Gigabit Ethernet 10GBASE-SR transceiver for use on multimode fiber cables. It is best suited for OM3 high bandwidth MMF link applications with link lengths up to 300 meters.
- AFCT-5016Z SFP+ Evaluation Board The purpose of this SFP+ evaluation board is to provide the designer with a convenient means for evaluating SFP+ fiber optic transceivers.

Features

- Avago 1310nm DFB source and Transmitter Optical Subassembly technology
- Avago PIN detector and Receiver Optical Subassembly technology
- Typical power dissipation 850mW
- Extended case temperature 0-85 °C
- Full digital diagnostic management interface
- Avago SFP+ package design enables equipment EMI performance in high port density applications with margin to Class B limits

Specifications

- Optical interface specifications per IEEE 802.3ae 10GBASE-LR
- Electrical interface specifications per SFF Committee SFF 8431 Specifications for Enhanced 8.5 and 10 Gigabit Small Form Factor Pluggable Module "SFP+"
- Management interface specifications per SFF Committee SFF 8431 and SFF 8472 Diagnostic Monitoring Interface for Optical Transceivers
- Mechanical specifications per SFF Committee SFF 8432 Improved Pluggable Formfactor "IPF"
- LC Duplex optical connector interface conforming to ANSI TIA/EIA 604-10 (FOCIS 10A)
- Compliant to Restriction on Hazardous Substances (RoHS) per EU and China requirements
- Class 1 Eye safe per requirements of IEC 60825-1 /CDRH

Description, continued

Installation

The AFCT-701ASDZ transceiver package is compliant with the SFF 8432 Improved Pluggable Formfactor housing specification for the SFP+. It can be installed in any INF-8074 or SFF-8431/2 compliant Small Form Pluggable (SFP) port regardless of host equipment operating status. The AFCT-701ASDZ is hot-pluggable, allowing the module to be installed while the host system is operating and on-line. Upon insertion, the transceiver housing makes initial contact with the host board SFP cage, mitigating potential damage due to Electro-Static Discharge (ESD).

Digital Diagnostic Interface and Serial Identification

The two-wire interface protocol and signaling detail are based on SFF-8431. Conventional EEPROM memory, bytes 0-255 at memory address 0xA0, is organized in compliance with SFF-8431. New digital diagnostic information, bytes 0-255 at memory address 0xA2, is compliant to SFF-8472. The new diagnostic information provides the opportunity for Predictive Failure Identification, Compliance Prediction, Fault Isolation and Component Monitoring.

Predictive Failure Identification

The AFCT-701ASDZ predictive failure feature allows a host to identify potential link problems before system performance is impacted. Prior identification of link problems enables a host to service an application via “fail over” to a redundant link or replace a suspect device, maintaining system uptime in the process. For applications where ultra-high system uptime is required, a digital SFP provides a means to monitor two real-time laser metrics associated with observing laser degradation and predicting failure: average laser bias current (Tx_Bias) and average laser optical power (Tx_Power).

Compliance Prediction

Compliance prediction is the ability to determine if an optical transceiver is operating within its operating and environmental requirements. AFCT-701ASDZ devices provide real-time access to transceiver internal supply voltage and temperature, allowing a host to identify potential component compliance issues. Received optical power is also available to assess compliance of a cable plant and remote transmitter. When operating out of requirements, the link cannot guarantee error free transmission.

Fault Isolation

The fault isolation feature allows a host to quickly pinpoint the location of a link failure, minimizing downtime. For optical links, the ability to identify a fault at a local device, remote device or cable plant is crucial to speeding service of an installation. AFCT-701ASDZ real-time monitors of Tx_Bias, Tx_Power, Vcc, Temperature and Rx_Power can be used to assess local transceiver current operating conditions. In addition, status flags TX_DISABLE and Rx Loss of Signal (LOS) are mirrored in memory and available via the two-wire serial interface.

Component Monitoring

Component evaluation is a more casual use of the AFCT-701ASDZ real-time monitors of Tx_Bias, Tx_Power, Vcc, Temperature and Rx_Power. Potential uses are as debugging aids for system installation and design, and transceiver parametric evaluation for factory or field qualification. For example, temperature per module can be observed in high density applications to facilitate thermal evaluation of blades, PCI cards and systems.

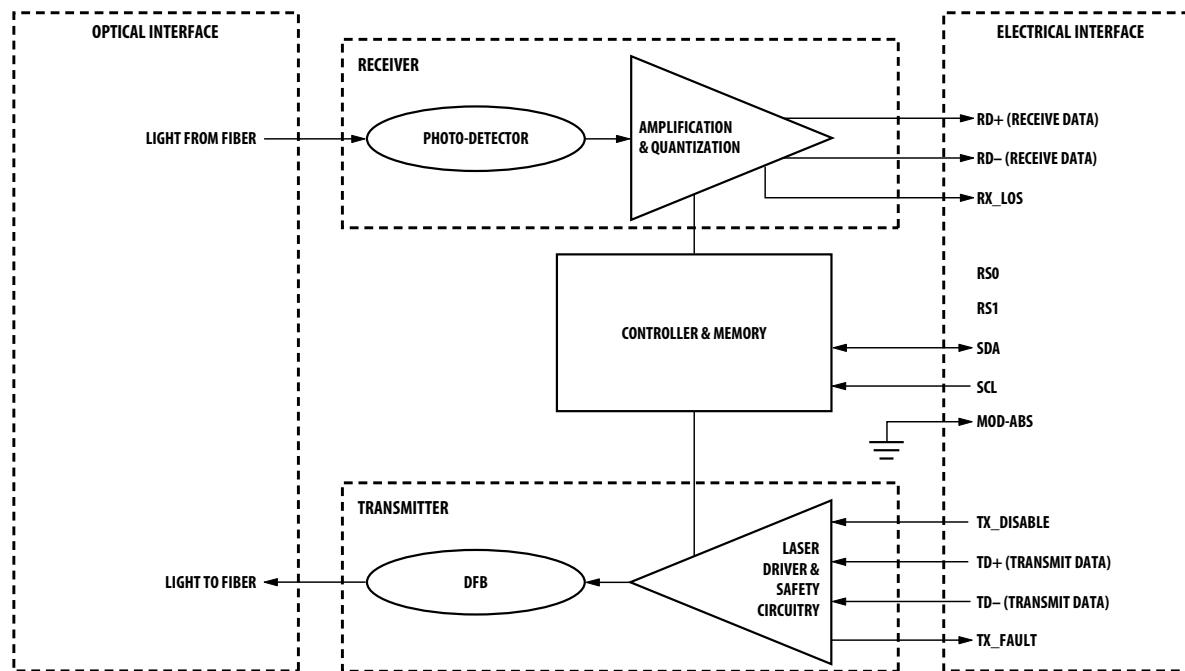

Figure 1. Transceiver functional diagram

Transmitter Section

The transmitter section includes the Transmitter Optical Sub-Assembly (TOSA) and laser driver circuitry. The TOSA, containing an Avago designed and manufactured 1310 nm DFB light source, is located at the optical interface and mates with the LC optical connector. The TOSA is driven by an IC which uses the incoming differential high speed logic signal to modulate the laser diode driver current. This Tx laser driver circuit regulates the optical power at a level within the specified range.

Transmit Disable (TX_DISABLE)

The AFCT-701ASDZ accepts an LVTTTL compatible transmit disable control signal input which shuts down the transmitter optical output. A high signal implements this function while a low signal allows normal transceiver operation. In the event of a fault (e.g. eye safety circuit activated), cycling this control signal resets the module as depicted in Figure 6. An internal pull up resistor disables the transceiver transmitter until the host pulls the input low. TX_DISABLE can also be asserted via the two-wire interface (address A2h, byte 110, bit 6) and monitored (address A2h, byte 110, bit 7).

The contents of A2h, byte 110, bit 6 are logic OR'd with hardware TX_DISABLE (contact 3) to control transmitter operation. The normal behavior of this feature is to reset a TX disabled transceiver to TX enabled when it is power cycled or hot-plugged.

Transmit Fault (TX_FAULT)

A catastrophic laser fault will activate the transmitter signal, TX_FAULT, and disable the laser. This signal is an open collector output (pull-up required on the host board). A low signal indicates normal laser operation and a high signal indicates a fault. A fault is defined as laser power below or above the specified IEEE 802.3ae specified min/max range. The TX_FAULT will be latched high when a laser fault occurs and is cleared by toggling the TX_DISABLE input or power cycling the transceiver. The transmitter fault condition can also be monitored via the two-wire serial interface (address A2, byte 110, bit 2).

Receiver Section

The receiver section includes the Receiver Optical Sub-Assembly (ROSA) and the amplification/quantization circuitry. The ROSA, containing a PIN photodiode and custom transimpedance amplifier, is located at the optical interface and mates with the LC optical connector. The ROSA output is fed to a custom IC that provides post-amplification and quantization.

Receiver Loss of Signal (Rx_LOS)

The post-amp IC also includes transition detection circuitry which monitors the AC level of incoming optical signals and provides a LVTTTL/CMOS compatible status signal to the host. A high status signal indicates loss of modulated signal, indicating link failures such as broken fiber or failed transmitter. Rx_LOS can also be monitored via the two-wire serial interface (address A2h, byte 110, bit 1).

Functional Data I/O

The AFCT-701ASDZ interfaces with the host circuit board through the twenty contact SFP+ electrical connector. See Table 2 for contact descriptions. The module edge connector is shown in Figure 4. The host board layout for this interface is depicted in Figure 8.

The AFCT-701ASDZ high speed transmit and receive interfaces require SFF-8431 compliant signal lines on the host board. To simplify board requirements, biasing resistors and AC coupling capacitors are incorporated into the SFP+ transceiver module (per SFF-8431) and hence are not required on the host board. The TX_DISABLE, TX_FAULT and RX_LOS signals require LVTTTL signals on the host board (per SFF-8431) if used. If an application does not take advantage of these functions, care must be taken to ground TX_DISABLE to enable normal operation.

Figure 2 depicts the recommended interface circuit to link the AFCT-701ASDZ to supporting physical layer ICs. Timing for the dedicated SFP+ control signals implemented in the transceiver are listed in Figure 6.

Application Support

An Evaluation Kit and Reference Designs are available to assist in evaluation of the AFCT-701ASDZ. Please contact your local Field Sales representative for availability and ordering details.

Caution

There are no user serviceable parts nor maintenance requirements for the AFCT-701ASDZ. All mechanical adjustments are made at the factory prior to shipment. Tampering with, modifying, misusing or improperly handling the AFCT-701ASDZ will void the product warranty. It may also result in improper operation and possibly overstress the laser source. Performance degradation or device failure may result. Connection of the AFCT-701ASDZ to a light source not compliant with IEEE Std. 802.3ae Clause 52 and SFF-8341 specifications, operating above maximum operating conditions or in a manner inconsistent with its design and function may result in exposure to hazardous light radiation and may constitute an act of modifying or manufacturing a laser product. Persons performing such an act are required by law to recertify and re-identify the laser product under the provisions of U.S. 21 CFR (Subchapter J) and TUV.

Customer Manufacturing Processes

This module is pluggable and is not designed for aqueous wash, IR reflow, or wave soldering processes.

Ordering Information

Please contact your local field sales engineer or one of Avago Technologies franchised distributors for ordering information. For technical information, please visit Avago Technologies' WEB page at www.avagotech.com. For information related to SFF Committee documentation visit www.sffcommittee.org.

Regulatory Compliance

The AFCT-701ASDZ complies with all applicable laws and regulations as detailed in Table 1. Certification level is dependent on the overall configuration of the host equipment. The transceiver performance is offered as a figure of merit to assist the designer.

Electrostatic Discharge (ESD)

The AFCT-701ASDZ is compatible with ESD levels found in typical manufacturing and operating environments as described in Table 1. In the normal handling and operation of optical transceivers, ESD is of concern in two circumstances.

The first case is during handling of the transceiver prior to insertion into an SFP compliant cage. To protect the device, it's important to use normal ESD handling precautions. These include use of grounded wrist straps, work-benches and floor wherever a transceiver is handled.

The second case to consider is static discharges to the exterior of the host equipment chassis after installation. If the optical interface is exposed to the exterior of host equipment cabinet, the transceiver may be subject to system level ESD requirements.

Electromagnetic Interference (EMI)

Equipment incorporating 10 gigabit transceivers is typically subject to regulation by the FCC in the United States, CENELEC EN55022 (CISPR 22) in Europe and VCCI in Japan. The AFCT-701ASDZ enables equipment compliance to these standards detailed in Table 1. The metal housing and shielded design of the AFCT-701ASDZ minimizes the EMI challenge facing the equipment designer. For superior EMI performance it is recommended that equipment designs utilize SFP+ cages per SFF 8432.

RF Immunity (Susceptibility)

Due to its shielded design, the EMI immunity of the AFCT-701ASDZ exceeds typical industry standards.

Eye Safety

The AFCT-701ASDZ provides Class 1 (single fault tolerant) eye safety by design and has been tested for compliance with the requirements listed in Table 1. The eye safety circuit continuously monitors the optical output power level and will disable the transmitter upon detecting a condition beyond the scope of Class 1 certification. Such conditions can be due to inputs from the host board (Vcc fluctuation, unbalanced code) or a fault within the transceiver. US CDRH and EU TUV certificates are listed in table 1.

Flammability

The AFCT-701ASDZ optical transceiver is made of metal and high strength, heat resistant, chemical resistant and UL 94V-0 flame retardant plastic.

Table 1. Regulatory Compliance

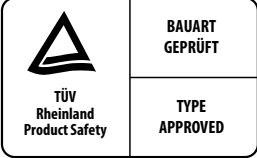
Feature	Test Method	Performance
Electrostatic Discharge (ESD) to the Electrical Contacts	MIL-STD883C Method 3015.4 JEDEC DESD22-A11-4-B	Class 1 (> 1KV) for high speed I/O pins Class 1 (> 2KV) for all other pins
Electrostatic Discharge (ESD) to the Duplex LC Receptacle	IEC 61000-4-2	Typically, no damage occurs with 25 kV when the duplex LC connector receptacle is contacted by a Human Body Model probe.
Life Traffic ESD Immunity	IEC 61000-4-2	10 contacts of 8 kV on the electrical faceplate with device inserted into a panel.
Life Traffic ESD Immunity	IEC 61000-4-2	Air discharge of 15 kV (min.) contact to connector without damage.
Electromagnetic Interference (EMI)	FCC Class B CENELEC EN55022 Class B (CISPR 22A) VCCI Class 1	System margins are dependent on customer board and chassis design.
RF Immunity	IEC 61000-4-3	Typically shows no measurable effect from a 10 V/m field swept from 80MHz to 1 GHz
Laser Eye Safety and Equipment Type Testing	US FDA CDRH AEL Class 1 US21 CFR, Subchapter J per Paragraphs 1002.10 and 1002.12 (IEC) EN60825-1: 1994 + A11 + A2 (IEC) EN60825-2: 1994 + A1 (IEC) EN60950: 1992 + A1 + A2 + A3 + A4 + A11	CDRH Accession No. 9521220-158 Pending Completion
	BAUART GEPRÜFT TYPE APPROVED	
Component Recognition	Underwriters Laboratories and Canadian Standards Association Joint Component Recognition for Information Technology Equipment including Electrical Business Equipment	UL file E173874
RoHS Compliance	RoHS Directive 2002/95/EC and it's amendment directives 6/6	SGS Test Report No. LPC1/00895/08 CTS ref. CTS/08-0238/Avago

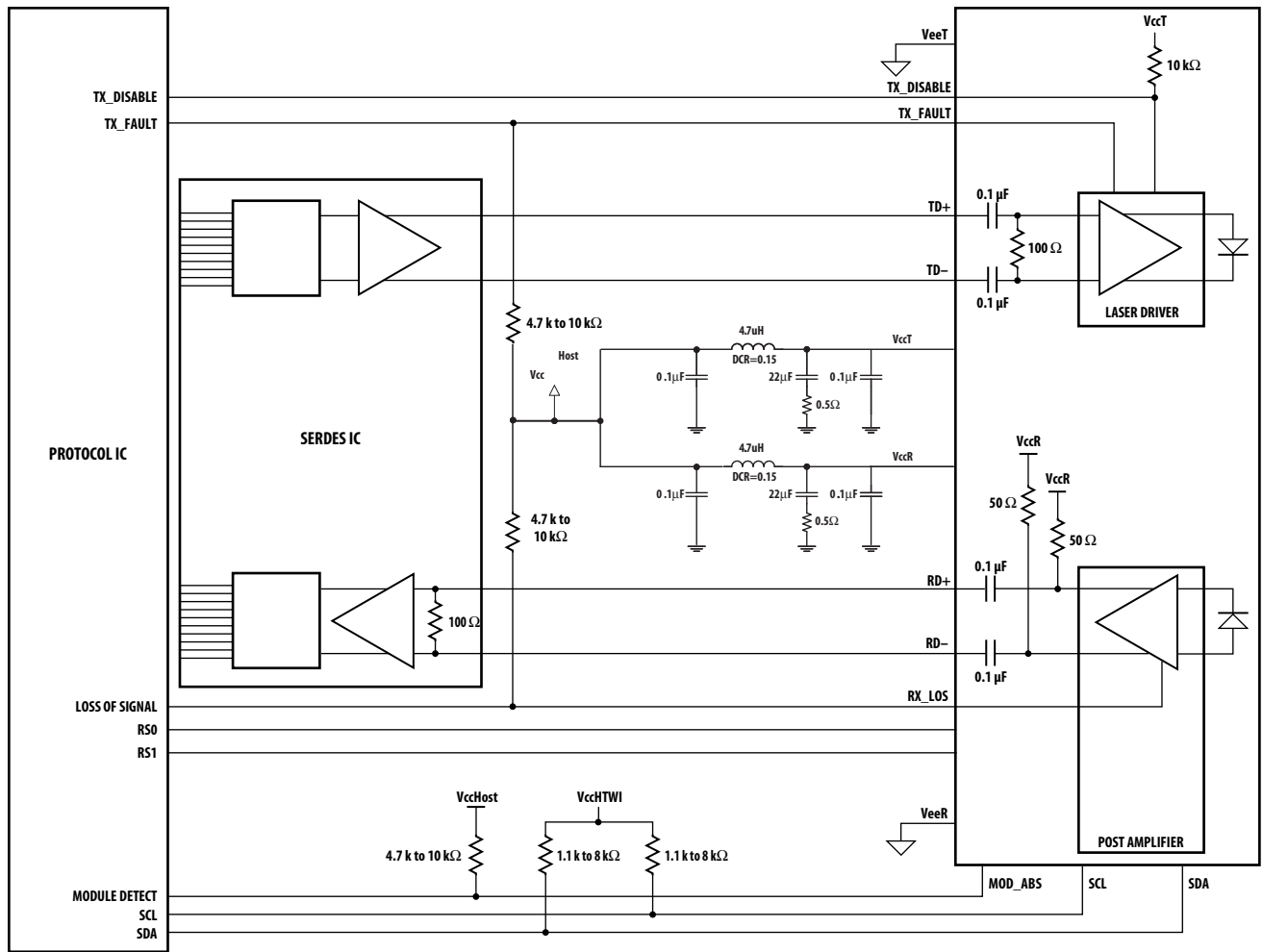

Figure 2. Typical application configuration

Table 2. Contact Description

Contact	Symbol	Function/Description	Notes
1	VeeT	Transmitter Signal Ground	Note 1
2	TX_FAULT	Transmitter Fault (LVTTTL-O) – High indicates a fault condition	Note 2
3	TX_DISABLE	Transmitter Disable (LVTTTL-I) – High or open disables the transmitter	Note 3
4	SDA	Two Wire Serial Interface Data Line (LVCMOS – I/O) (same as MOD-DEF2 in INF-8074)	Note 4
5	SCL	Two Wire Serial Interface Clock Line (LVCMOS – I/O) (same as MOD-DEF1 in INF-8074)	Note 4
6	MOD_ABS	Module Absent (Output), connected to VeeT or VeeR in the module	Note 5
7	RS0	Rate Select 0 - Not used, Presents high input impedance.	
8	RX_LOS	Receiver Loss of Signal (LVTTTL-O)	Note 2
9	RS1	Rate Select 1 - Not used, Presents high input impedance.	
10	VeeR	Receiver Signal Ground	Note 1
11	VeeR	Receiver Signal Ground	Note 1
12	RD-	Receiver Data Out Inverted (CML-O)	
13	RD+	Receiver Data Out (CML-O)	
14	VeeR	Receiver Signal Ground	
15	VccR	Receiver Power + 3.3 V	
16	VccT	Transmitter Power + 3.3 V	
17	VeeT	Transmitter Signal Ground	Note 1
18	TD+	Transmitter Data In (CML-I)	
19	TD-	Transmitter Data In Inverted (CML-I)	
20	VeeT	Transmitter Signal Ground	Note 1

Notes:

1. The module signal grounds are isolated from the module case.
2. This is an open collector/drain output that on the host board requires a 4.7 kΩ to 10 kΩ pullup resistor to VccHost. See Figure 2.
3. This input is internally biased high with a 4.7 kΩ to 10 kΩ pullup resistor to VccT.
4. Two-Wire Serial interface clock and data lines require an external pullup resistor dependent on the capacitance load.
5. This is a ground return that on the host board requires a 4.7 kΩ to 10 kΩ pullup resistor to VccHost.

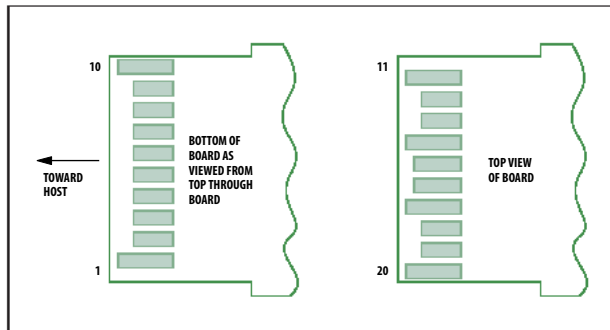

Figure 3. Module edge connector contacts

Table 3. Absolute Maximum Ratings

Stress in excess of any of the individual Absolute Maximum Ratings can cause immediate catastrophic damage to the module even if all other parameters are within Recommended Operating Conditions. It should not be assumed that limiting values of more than one parameter can be applied concurrently. Exposure to any of the Absolute Maximum Ratings for extended periods can adversely affect reliability.

Parameter	Symbol	Minimum	Maximum	Unit	Notes
Storage Temperature	T _S	-40	100	C	
Case Operating Temperature	T _C	-40	100	C	
Relative Humidity	RH	5	95	%	
Supply Voltage	V _{ccT} , V _{ccR}	-0.3	3.8	V	Note 1
Low Speed Input Voltage		-0.5	V _{cc} +0.5	V	
Two-Wire Interface Input Voltage		-0.5	V _{cc} +0.5	V	
High Speed Input Voltage, Single Ended		-0.3	V _{cc} +0.5	V	
High Speed Input Voltage, Differential			2.5	V	
Low Speed Output Current		-20	20	mA	
Optical Receiver Input Average Power			1.5	dBm	

Note:

1. The module supply voltages, V_{ccT} and V_{ccR} must not differ by more than 0.5 V or damage to the device may occur.

Table 4. Recommended Operating Conditions

Recommended Operating Conditions specify parameters for which the electrical and optical characteristics hold unless otherwise noted. Optical and electrical characteristics are not defined for operation outside the Recommended Operating Conditions, reliability is not implied and damage to the module may occur for such operation over an extended period of time. The SFP+ Module Power Supply Requirements are specified in the latest revision of SFF 8431 MSA.

Parameter	Symbol	Minimum	Maximum	Unit	Notes
Case Operating Temperature	T _C	0	85	°C	Note 1
Module Supply Voltage	V _{ccT} , V _{ccR}	3.135	3.465	V	
Signal Rate		10.311	10.313	GBd	
Power Supply Noise Tolerance including Ripple			66	mVp-p	
Tx Input Single Ended DC Voltage Tolerance (Ref V _{eeT})	V	-0.3	4.0	V	
Rx Output Single Ended Voltage Tolerance	V	-0.3	4.0	V	

Notes:

1. Ambient operating temperature limits are based on the Case Operating Temperature limits and are subject to the host system thermal design. See Figure 7 for the module T_c reference point.
2. The Power Supply Filter (PSF) and resulting Power Supply Noise Tolerance (PSNT) are specified in the SFF 8431 MSA. The PSNT value applies over the range from 10Hz to 10MHz.

Table 5. Low Speed Signal Electrical Characteristics

The following characteristics are defined over the Recommended Operating Conditions unless otherwise noted. Typical values are for $T_c = 40^\circ\text{C}$. V_{ccT} and $V_{ccR} = 3.3\text{ V}$.

Parameter	Symbol	Minimum	Typical	Maximum	Unit	Notes
Module Supply Current	I_{CC}		258	361	mA	Note 1
Power Dissipation	P_{DISS}		850	1250	mW	
TX_FAULT, RX_LOS	I_{OH}	- 50		+ 37.5	μA	Note 2
	V_{OL}	- 0.3		0.4	V	
TX_DISABLE	V_{IH}	2.0		$V_{ccT} + 0.3$	V	Note 3
	V_{IL}	-0.3		0.8	V	

Notes:

1. Supply current includes both V_{ccT} and V_{ccR} connections.
2. Measured with a 4.7 k Ω load to V_{ccHost} .
3. TX_DISABLE has an internal 4.7 k Ω to 10 k Ω pull-up to V_{ccT}

Table 6. High Speed Signal Electrical Characteristics

The following characteristics are defined over the Recommended Operating Conditions unless otherwise noted.

Parameter	Symbol	Minimum	Typical	Maximum	Unit	Notes
Tx Input Differential Voltage, (TD +) - (TD-)	V_I	180	700		mV	Note 1
Tx Input AC Common Mode Voltage Tolerance			15		mV(RMS)	
Tx Input Differential S-parameter (100 Ω Ref.)	SDD11			-12	dB	0.01-1.0 GHz
				Note 3	dB	1.0-11.1 GHz
Tx Input Reflected Differential to Common Mode Conversion (25 Ω Ref.)	SCD11		-10		dB	0.01-11.1 GHz
Rx Output Differential Voltage, (RD +) - (RD-)	V_o	300	850		mV	Note 2
Rx Output Termination Mismatch @ 1MHz	ΔZ_m		5		%	
Rx Output AC Common Mode Voltage			7.5		mV(RMS)	Note 5
Rx Output Output Rise and Fall Time (20% to 80%)	t_r, t_f	28			ps	
Rx Output Total Jitter	TJ		0.70		Ulp-p	
Rx Output Deterministic Jitter	DJ		0.42		Ulp-p	
Rx Output Differential S-parameter (100 Ω Ref.)	SDD22			-12	dB	0.01-1.0 GHz
				Note 4	dB	1.0-11.1 GHz
Rx Output Common Mode Reflection Coefficient (25 Ω Ref.)	SCC22			-6	dB	0.01-2.5 GHz
				-3	dB	2.5-11.1 GHz
Receiver Output Eye Mask						See Figure 5a

Notes:

1. Internally AC coupled and terminated (100 Ohm differential).
2. Internally AC coupled but requires an external load termination (100 Ohm differential).
3. Reflection Coefficient given by equation $SDD11(\text{dB}) = \text{Max}(-12 + 2 * \text{SQRT}(f) - 6.3 + 13 \text{Log}_{10}(f/5.5))$, with f in GHz.
4. Differential Output S-parameter given by equation $SDD22(\text{dB}) = \text{Max}(-12 + 2 * \text{SQRT}(f) - 6.3 + 13 \text{Log}_{10}(f/5.5))$, with f in GHz.
5. The RMS value is measured by calculating the standard deviation of the histogram for one UI of the common mode signal.

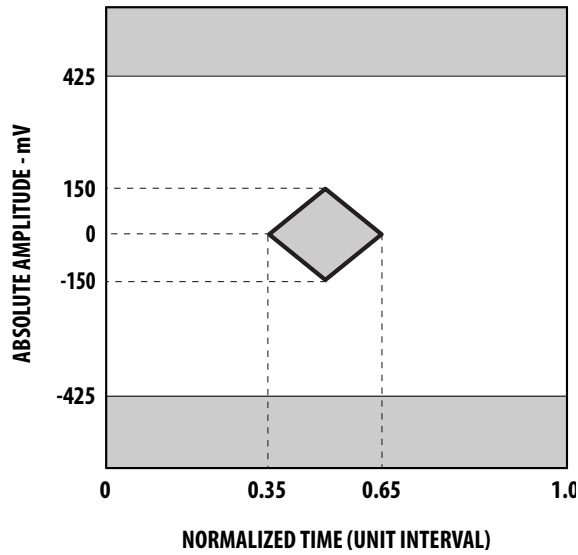

Figure 4a. Receiver Electrical Optical Eye Mask Definition

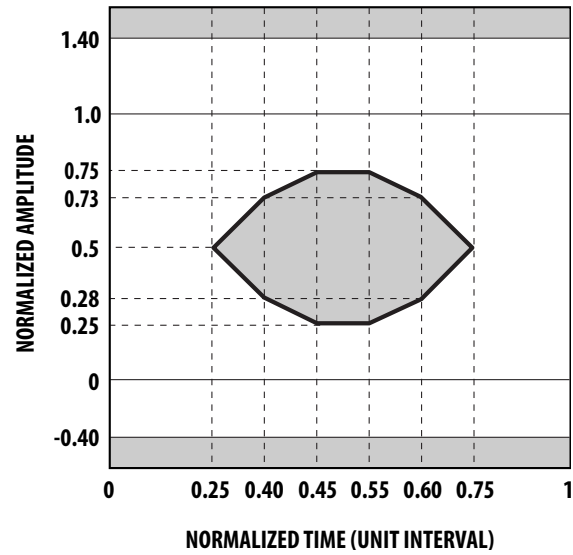

Figure 4b. Transmitter Optical Eye Mask Definition

Table 7. Two-Wire Interface Electrical Characteristics

Parameter	Symbol	Min.	Max.	Unit	Conditions
Host Vcc Range	VccHTWI	3.135	3.465	V	
SCL and SDA	V _{OL}	0.0	0.40	V	Rp ^[1] pulled to VccHTWI, measured at host side of connector
	V _{OH}	VccHTWI - 0.5	VccHTWI + 0.3	V	
SCL and SDA	V _{IL}	-0.3	VccT*0.3	V	
	V _{IH}	VccT*0.7	VccT + 0.5	V	
Input Current on the SCL and SDA Contacts	I _I	-10	10	μA	
Capacitance on SCL and SDA Contacts	C _i ^[2]		14	pF	
Total bus capacitance for SCL and for SDA	C _b ^[3]		100	pF	At 400 kHz, 3.0 kΩ Rp, max At 100 kHz, 8.0 kΩ Rp, max
			290	pF	At 400 kHz, 1.1 kΩRp, max At 100 kHz, 2.75 kΩ Rp, max

Notes:

1. Rp is the pull up resistor. Active bus termination may be used by the host in place of a pullup resistor. Pull ups can be connected to various power supplies, however the host board design shall ensure that no module contact has voltage exceeding VccT or VccR by 0.5 V nor requires the module to sink more than 3.0 mA current.
2. C_i is the capacitance looking into the module SCL and SDA contacts
3. C_b is the total bus capacitance on the SCL or SDA bus.

Table 8. Optical Specifications

The following characteristics are defined over the Recommended Operating Conditions unless otherwise noted.

Parameter	Minimum	Typical	Maximum	Units	Notes
Transmitter					
Laser OMA output power	-5.2			dBm	1
Laser mean output power	-8.2		0.5	dBm	1
Laser off power			-30	dBm	1
Extinction ratio	3.5			dB	1
Transmitter and dispersion penalty (TDP)			3.2	dB	1
Center Wavelength	1260		1355	nm	
Side Mode Suppression Ratio - SMSR	30			dB	
RIN _{12OMA}			-128	dB/Hz	1
Optical Return Loss Tolerance			12	dB	1
Transmitter Output Eye Mask					1, See Figure 5b
Receiver					
Stressed sensitivity (OMA)			-10.3	dBm	1
Receive sensitivity (OMA)			-12.6	dBm	
Receive Power (Pave) Overload	0.5			dBm	1
Reflectance			-12	dB	1
Center Wavelength	1260		1355	nm	1
RX_LOS (OMA) De-Assert			-17	dBm	3
RX_LOS (OMA) Assert	-30			dBm	3
RX_LOS (OMA) Hysteresis	0.5			dB	

General Specification Considerations (Notes):

1. IEEE 802.3ae Clause 52 compliant.
2. Vertical eye closure and stressed eye jitter are test conditions for stressed sensitivity (OMA) measurements.
3. Loss of Signal (LOS) detection responds only to OMA and the indicator will respond unpredictably with the application of unmodulated optical power.

Table 9. Control Functions: Low Speed Signals Timing Characteristics

The following characteristics are defined over the Recommended Operating Conditions unless otherwise noted.

Parameter	Symbol	Minimum	Maximum	Unit	Notes
TX_DISABLE Assert Time	t_off		100	μs	Note 1 , Fig. 6
TX_DISABLE Negate Time	t_on		2	ms	Note 2 , Fig. 6
Time to initialize, including reset of TX_FAULT	t_init		300	ms	Note 3 , Fig. 6
TX_FAULT Assert Time	t_fault		1000	μs	Note 4 , Fig. 6
TX_DISABLE to Reset	t_reset	10		μs	Note 5 , Fig. 6
RX_LOS Assert Time	t_los_on		100	μs	Note 6 , Fig. 6
RX_LOS Deassert Time	t_los_off		100	μs	Note 7 , Fig. 6

Notes:

1. Time from rising edge of TX_DISABLE to when the optical output falls below 10% of nominal. A 10 ms interval between assertions of TX_DISABLE is required.
2. Time from falling edge of TX_DISABLE to when the modulated optical output rises above 90% of nominal.
3. Time from power on or falling edge of TX_DISABLE to when the modulated optical output rises above 90% of nominal and the Two-Wire interface is available.
4. From power on or negation of TX_FAULT using TX_DISABLE.
5. Time TX_DISABLE must be held high to reset the laser fault shutdown circuitry.
6. Time from loss of optical signal to Rx_LOS Assertion.
7. Time from valid optical signal to Rx_LOS De-Assertion.

Table 10. Control Functions: Two-Wire Interface Timing Characteristics

The following characteristics are defined over the Recommended Operating Conditions unless otherwise noted.

Parameter	Symbol	Minimum	Maximum	Unit	Notes
TX_DISABLE Assert Time	t_off_twi		100	ms	Note 1
TX_DISABLE Negate Time	t_on_twi		100	ms	Note 2
TX_FAULT Assert Time	t_fault_twi		100	ms	Note 3
Rx_LOS Assert Time	t_loss_on_twi		100	ms	Note 4
Rx_LOS Deassert Time	t_loss_off_twi		100	ms	Note 5
Analog parameter data ready	t_data		1000	ms	Note 6
Two-Wire Interface Ready	t_serial		300	ms	Note 7
Complete Single or Sequential Write up to 4 Byte	t_write		40	ms	Note 8
Complete Sequential Write of 5-8 Byte	t_write		80	ms	Note 8
Two-Wire Interface Clock Rate	f_serial_clock		400	kHz	Note 8
Time bus free before new transmission can start	t_BUF	20		μs	Note 9

1. Time from two-wire interface assertion of TX_DISABLE (A2h, byte 110, bit 6) to when the optical output falls below 10% of nominal. Measured from falling clock edge after stop bit of write transaction.
2. Time from two-wire interface de-assertion of TX_DISABLE (A2h, byte 110, bit 6) to when the modulated optical output rises above 90% of nominal.
3. Time from fault to two-wire interface TX_FAULT (A2h, byte 110, bit 2) asserted.
4. Time for two-wire interface assertion of Rx_LOS (A2h, byte 110, bit 1) from loss of optical signal.
5. Time for two-wire interface de-assertion of Rx_LOS (A2h, byte 110, bit 1) from presence of valid optical signal.
6. From power on to data ready bit asserted (A2h, byte 110, bit 0). Data ready indicates analog monitoring circuitry is functional.
7. Time from power on until module is ready for data transmission over the two-wire interface (reads or writes over A0h and A2h).
8. Operation of the Two Wire Serial Interface at rates beyond 100kHz requires the use of clock stretching techniques.
9. Between STOP and START. See SFF 8431 Section 4.3

Table 11. Transceiver Digital Diagnostic Monitor (Real Time Sense) Characteristics

The following characteristics are defined over the Recommended Operating Conditions unless otherwise noted.

Parameter	Symbol	Min.	Units	Notes
Transceiver Internal Temperature	T_{INT}	± 3.0	$^{\circ}C$	Temperature is measured internal to the transceiver. Valid from $-10^{\circ}C$ to $85^{\circ}C$ case temperature.
Transceiver Internal Supply Voltage	V_{INT}	± 0.1	V	Supply voltage is measured internal to the transceiver and can, with less accuracy, be correlated to voltage at the V_{ccT} contact. Valid over $3.3V \pm 10\%$.
Transmitter Laser DC Bias Current	I_{INT}	± 10	%	I_{INT} accuracy is better than $\pm 10\%$ of the nominal value.
Transmitted Average Optical Output Power	P_T	± 3.0	dB	Average Power coupled into $9/125 \mu m$ single-mode fiber. Valid from $151 \mu W$ to $1120 \mu W$.
Received Average Optical Input Power	P_R	± 3.0	dB	Average Power coupled from $9/125 \mu m$ single-mode fiber. Valid from $25 \mu W$ to $1120 \mu W$.

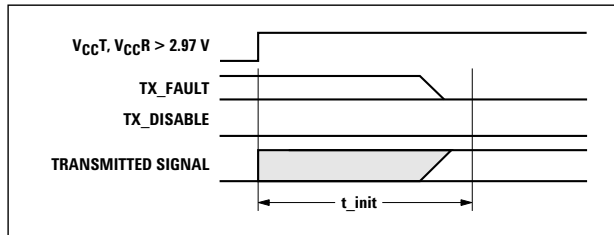

t-init: TX DISABLE NEGATED

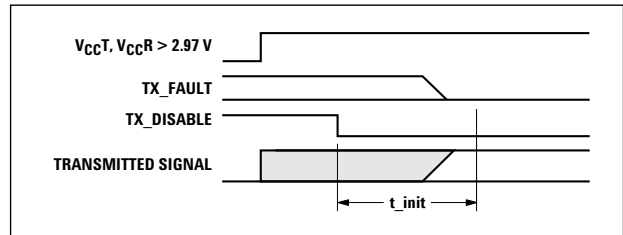

t-init: TX DISABLE ASSERTED

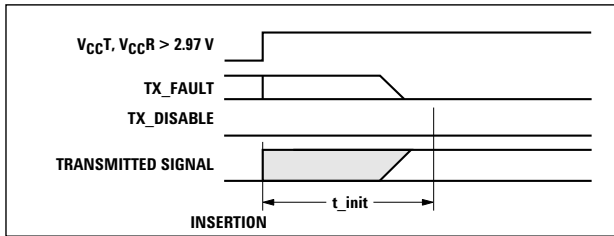

t-init: TX DISABLE NEGATED, MODULE HOT PLUGGED

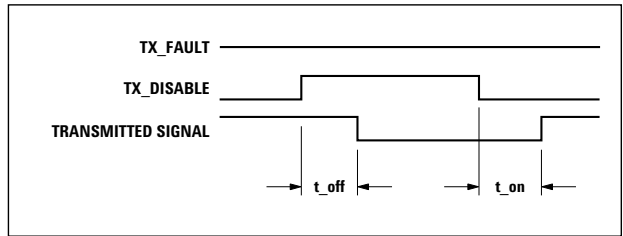

t-off & t-on: TX DISABLE ASSERTED THEN NEGATED

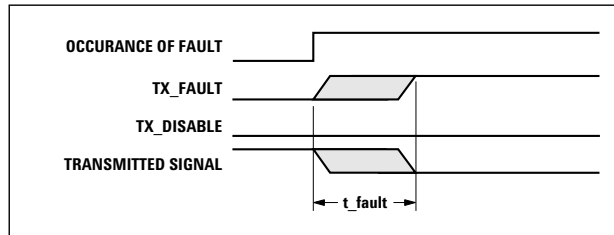

t-fault: TX FAULT OCCURED

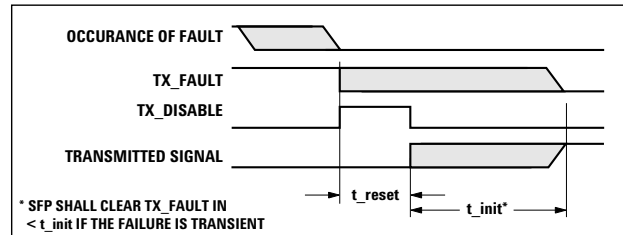

t-reset: TX DISABLE ASSERTED THEN NEGATED, TX SIGNAL RECOVERED

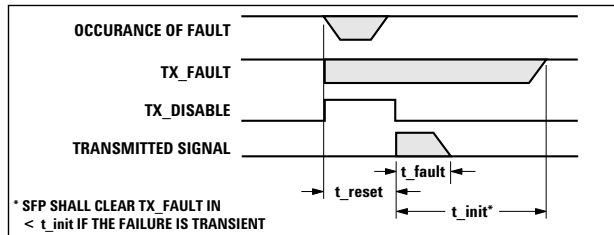

t-fault: TX DISABLE ASSERTED THEN NEGATED, TX SIGNAL NOT RECOVERED

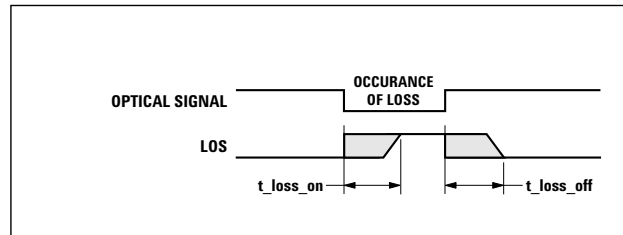

t-loss-on & t-loss-off

Figure 5. Transceiver timing diagrams (module installed and power applied except where noted)

Table 12. EEPROM Serial ID Memory Contents – Conventional SFP Memory (Address A0h)

Byte # Decimal	Data Hex	Notes	Byte # Decimal	Data Hex	Notes
0	03	SFP physical device	37	00	Hex Byte of Vendor OUI ^[1]
1	04	SFP function defined by serial ID only	38	17	Hex Byte of Vendor OUI ^[1]
2	07	LC optical connector	39	6A	Hex Byte of Vendor OUI ^[1]
3	20	10G Base-LR	40	41	"A" - Vendor Part Number ASCII character
4	00		41	46	"F" - Vendor Part Number ASCII character
5	00		42	43	"C" - Vendor Part Number ASCII character
6	00		43	54	"T" - Vendor Part Number ASCII character
7	00		44	2D	"-" - Vendor Part Number ASCII character
8	00		45	37	"7" - Vendor Part Number ASCII character
9	00		46	30	"0" - Vendor Part Number ASCII character
10	00		47	31	"1" - Vendor Part Number ASCII character
11	06	64B/66B	48	41	"A" - Vendor Part Number ASCII character
12	67	10312.5 Mbit/sec nominal bit rate (10.3125 Gbit/s)	49	53	"S" - Vendor Part Number ASCII character
13	00	Unspecified	50	44	"D" - Vendor Part Number ASCII character
14	0A	10GBASE-LR 10km	51	5A	"Z" - Vendor Part Number ASCII character
15	64	10GBASE-LR 10km	52	20	" " - Vendor Part Number ASCII character
16	00		53	20	" " - Vendor Part Number ASCII character
17	00		54	20	" " - Vendor Part Number ASCII character
18	00		55	20	" " - Vendor Part Number ASCII character
19	00		56	20	" " - Vendor Part Number ASCII character
20	41	"A" - Vendor Name ASCII character	57	20	" " - Vendor Part Number ASCII character
21	56	"V" - Vendor Name ASCII character	58	20	" " - Vendor Part Number ASCII character
22	41	"A" - Vendor Name ASCII character	59	20	" " - Vendor Part Number ASCII character
23	47	"G" - Vendor Name ASCII character	60	05	Hex Byte of Laser Wavelength ^[2]
24	4F	"O" - Vendor Name ASCII character	61	1E	Hex Byte of Laser Wavelength ^[2]
25	20	" " - Vendor Name ASCII character	62	00	
26	20	" " - Vendor Name ASCII character	63		Checksum for Bytes 0-62 ^[3]
27	20	" " - Vendor Name ASCII character	64	00	Receiver limiting output. 1 Watt power class.
28	20	" " - Vendor Name ASCII character	65	1A	Hardware SFP TX_DISABLE, TX_FAULT, & RX_LOS
29	20	" " - Vendor Name ASCII character	66	00	
30	20	" " - Vendor Name ASCII character	67	00	
31	20	" " - Vendor Name ASCII character	68-83		Vendor Serial Number ASCII characters ^[4]
32	20	" " - Vendor Name ASCII character	84-91		Vendor Date Code ASCII characters ^[5]
33	20	" " - Vendor Name ASCII character	92	68	Digital Diagnostics, Internal Cal, Rx Pwr Avg
34	20	" " - Vendor Name ASCII character	93	F0	A/W, Soft SFP TX_DISABLE, TX_FAULT, & RX_LOS
35	20	" " - Vendor Name ASCII character	94	03	SFF-8472 Compliance to revision 10.2
36	00		95		Checksum for Bytes 64-94 ^[3]
			96 - 255	00	

Notes:

1. The IEEE Organizationally Unique Identifier (OUI) assigned to Avago Technologies is 00-17-6A (3 bytes of hex).
2. Laser wavelength is represented in 16 unsigned bits.
3. Addresses 63 and 95 are checksums calculated (per SFF-8472) and stored prior to product shipment.
4. Addresses 68-83 specify the AFCT-701ASDZ ASCII serial number and will vary on a per unit basis.
5. Addresses 84-91 specify the AFCT-701ASDZ ASCII date code and will vary on a per date code basis.

Table 13. EEPROM Serial ID Memory Contents – Enhanced Feature Set Memory (Address A2h)

Byte # Decimal	Notes	Byte # Decimal	Notes	Byte # Decimal	Notes
0	Temp H Alarm MSB ^[1]	26	Tx Pwr L Alarm MSB ^[4]	104	Real Time Rx Pwr MSB ^[5]
1	Temp H Alarm LSB ^[1]	27	Tx Pwr L Alarm LSB ^[4]	105	Real Time Rx Pwr LSB ^[5]
2	Temp L Alarm MSB ^[1]	28	Tx Pwr H Warning MSB ^[4]	106	Reserved
3	Temp L Alarm LSB ^[1]	29	Tx Pwr H Warning LSB ^[4]	107	Reserved
4	Temp H Warning MSB ^[1]	30	Tx Pwr L Warning MSB ^[4]	108	Reserved
5	Temp H Warning LSB ^[1]	31	Tx Pwr L Warning LSB ^[4]	109	Reserved
6	Temp L Warning MSB ^[1]	32	Rx Pwr H Alarm MSB ^[5]	110	Status/Control - See Table 15
7	Temp L Warning LSB ^[1]	33	Rx Pwr H Alarm LSB ^[5]	111	Reserved
8	Vcc H Alarm MSB ^[2]	34	Rx Pwr L Alarm MSB ^[5]	112	Flag Bits - See Table 16
9	Vcc H Alarm LSB ^[2]	35	Rx Pwr L Alarm LSB ^[5]	113	Flag Bits - See Table 16
10	Vcc L Alarm MSB ^[2]	36	Rx Pwr H Warning MSB ^[5]	114	Reserved
11	Vcc L Alarm LSB ^[2]	37	Rx Pwr H Warning LSB ^[5]	115	Reserved
12	Vcc H Warning MSB ^[2]	38	Rx Pwr L Warning MSB ^[5]	116	Flag Bits - See Table 16
13	Vcc H Warning LSB ^[2]	39	Rx Pwr L Warning LSB ^[5]	117	Flag Bits - See Table 16
14	Vcc L Warning MSB ^[2]	40-55	Reserved	118-127	Reserved
15	Vcc L Warning LSB ^[2]	56-94	External Calibration Constants ^[6]	128-247	Customer Writeable
16	Tx Bias H Alarm MSB ^[3]	95	Checksum for Bytes 0-94 ^[7]	248-255	Vendor Specific
17	Tx Bias H Alarm LSB ^[3]	96	Real Time Temperature MSB ^[1]		
18	Tx Bias L Alarm MSB ^[3]	97	Real Time Temperature LSB ^[1]		
19	Tx Bias L Alarm LSB ^[3]	98	Real Time Vcc MSB ^[2]		
20	Tx Bias H Warning MSB ^[3]	99	Real Time Vcc LS ^[2]		
21	Tx Bias H Warning LSB ^[3]	100	Real Time Tx Bias MSB ^[3]		
22	Tx Bias L Warning MSB ^[3]	101	Real Time Tx Bias LSB ^[3]		
23	Tx Bias L Warning LSB ^[3]	102	Real Time Tx Power MSB ^[4]		
24	Tx Pwr H Alarm MSB ^[4]	103	Real Time Tx Power LSB ^[4]		
25	Tx Pwr H Alarm LSB ^[4]				

Notes:

1. Temperature (Temp) is decoded as a 16 bit signed twos compliment integer in increments of 1/256°C.
2. Supply Voltage (Vcc) is decoded as a 16 bit unsigned integer in increments of 100 μ V.
3. Laser bias current (Tx Bias) is decoded as a 16 bit unsigned integer in increments of 2 μ A.
4. Transmitted average optical power (Tx Pwr) is decoded as a 16 bit unsigned integer in increments of 0.1 μ W.
5. Received average optical power (Rx Pwr) is decoded as a 16 bit unsigned integer in increments of 0.1 μ W.
6. Bytes 56-94 are not intended for use with AFCT-701ASDZ, but have been set to default values per SFF-8472.
7. Byte 95 is a checksum calculated (per SFF-8472) and stored prior to product shipment.

Table 14. EEPROM Serial ID Memory Contents – Soft Commands (Address A2h, Byte 110)

Bit #	Status/ Control Name	Description	Notes
7	TX_DISABLE State	Digital state of SFP TX_DISABLE Input (1 = TX_DISABLE asserted)	Note 1
6	Soft TX_DISABLE	Read/write bit for changing digital state of TX_DISABLE function	Note 1, 2
5	Reserved		
4	Reserved		
3	Reserved		
2	TX_FAULT State	Digital state of the SFP TX_FAULT Output (1 = TX_FAULT asserted)	Note 1
1	RX_LOS State	Digital state of the SFP RX_LOS Output (1 = RX_LOS asserted)	Note 1
0	Data Ready (Bar)	Indicates transceiver is powered and real time sense data is ready. (0 = Ready)	

Notes:

1. The response time for soft commands of the AFCT-701ASDZ is 100 msec as specified by SFF-8472.
2. Bit 6 is logic OR'd with the SFP TX_DISABLE input on contact 3; either asserted will disable the SFP+ transmitter.

Table 15. EEPROM Serial ID Memory Contents – Alarms and Warnings (Address A2h, Bytes 112, 113, 116, 117)

Byte	Bit	Flag Bit Name	Description
112	7	Temp High Alarm	Set when transceiver internal temperature exceeds high alarm threshold
	6	Temp Low Alarm	Set when transceiver internal temperature exceeds low alarm threshold
	5	Vcc High Alarm	Set when transceiver internal supply voltage exceeds high alarm threshold
	4	Vcc Low Alarm	Set when transceiver internal supply voltage exceeds low alarm threshold
	3	Tx Bias High Alarm	Set when transceiver laser bias current exceeds high alarm threshold
	2	Tx Bias Low Alarm	Set when transceiver laser bias current exceeds low alarm threshold
	1	Tx Power High Alarm	Set when transmitted average optical power exceeds high alarm threshold
	0	Tx Power Low Alarm	Set when transmitted average optical power exceeds low alarm threshold
113	7	Rx Power High Alarm	Set when received average optical power exceeds high alarm threshold
	6	Rx Power Low Alarm	Set when received average optical power exceeds low alarm threshold
	0-5	Reserved	
116	7	Temp High Warning	Set when transceiver internal temperature exceeds high warning threshold
	6	Temp Low Warning	Set when transceiver internal temperature exceeds low warning threshold
	5	Vcc High Warning	Set when transceiver internal supply voltage exceeds high warning threshold
	4	Vcc Low Warning	Set when transceiver internal supply voltage exceeds low warning threshold
	3	Tx Bias High Warning	Set when transceiver laser bias current exceeds high warning threshold
	2	Tx Bias Low Warning	Set when transceiver laser bias current exceeds low warning threshold
	1	Tx Power High Warning	Set when transmitted average optical power exceeds high warning threshold
	0	Tx Power Low Warning	Set when transmitted average optical power exceeds low warning threshold
117	7	Rx Power High Warning	Set when received average optical power exceeds high warning threshold
	6	Rx Power Low Warning	Set when received average optical power exceeds low warning threshold
	0-5	Reserved	

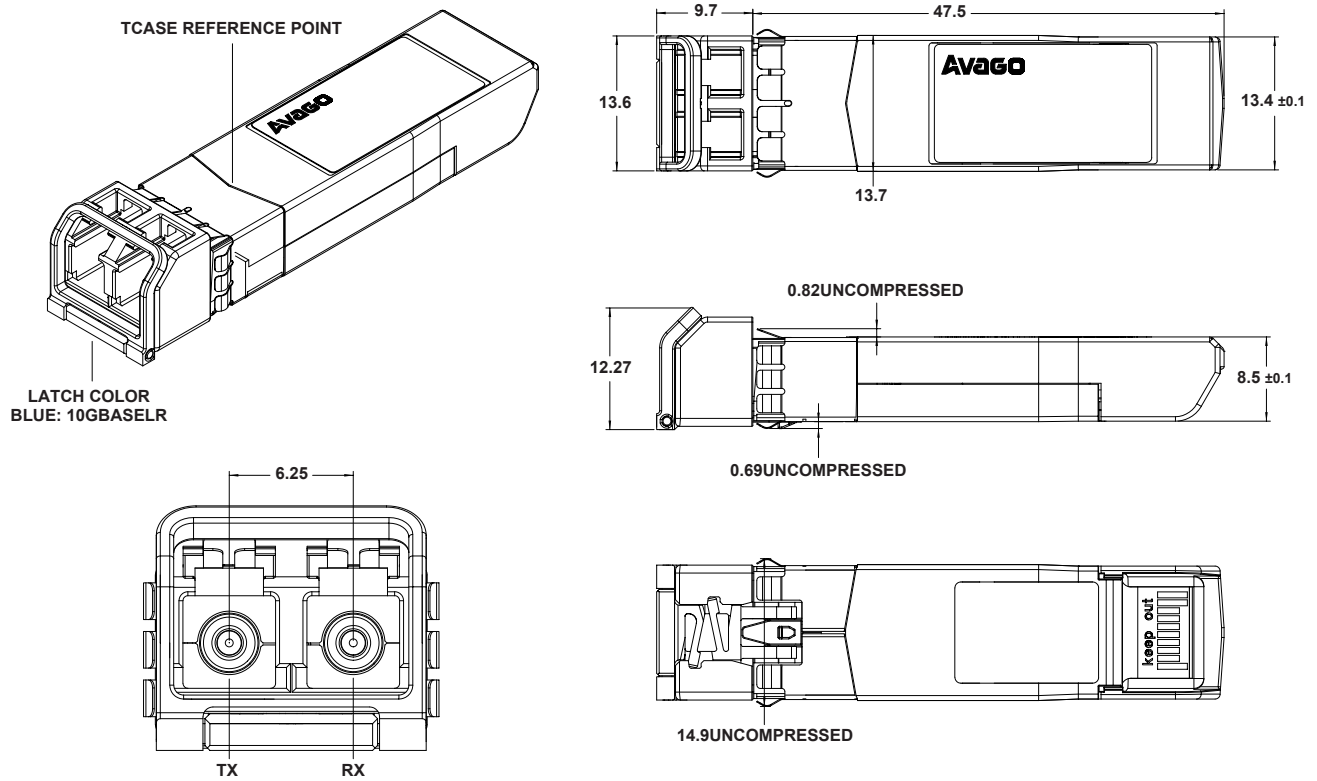

Figure 6. Module drawing

Label format



For product information and a complete list of distributors, please go to our website: www.avagotech.com

Avago, Avago Technologies, and the A logo are trademarks of Avago Technologies in the United States and other countries.
Data subject to change. Copyright © 2005-2009 Avago Technologies. All rights reserved.
AV02-1534EN - March 23, 2009

