

# Hyper TOPLED® Hyper-Bright LED

LS T676, LA T676, LO T676, LY T676



## Besondere Merkmale

- **Gehäusetyp:** weißes P-LCC-2 Gehäuse
- **Besonderheit des Bauteils:** extrem breite Abstrahlcharakteristik; ideal für Hinterleuchtungen und Einkopplungen in Lichtleiter
- **Wellenlänge:** 633 nm (super-rot), 617 nm (amber), 606 nm (orange), 587 nm (gelb)
- **Abstrahlwinkel:** Lambertscher Strahler (120°)
- **Technologie:** InGaAlP
- **optischer Wirkungsgrad:** 11 lm/W (gelb, orange, amber), 7 lm/W (super-rot)
- **Gruppierungsparameter:** Lichtstärke, Wellenlänge
- **Verarbeitungsmethode:** für alle SMT-Bestücktechniken geeignet
- **Lötmethode:** IR Reflow Löten und Wellenlöten (TTW)
- **Vorbehandlung:** nach JEDEC Level 2
- **Gurtung:** 8-mm Gurt mit 2000/Rolle, ø180 mm oder 8000/Rolle, ø330 mm
- **ESD-Festigkeit:** ESD-sicher bis 2 kV nach EOS/ESD-5.1-1993

## Anwendungen

- Ampelanwendung (EN 12368, nur für amber gültig; EN 12368, ITE VTCSH part 2, für super-rot, verde, gelb gültig)
- Informationsanzeigen im Innen- und Außenbereich (z. B. im Verkehrsbereich; Laufschriftanzeigen)
- optischer Indikator
- Einkopplung in Lichtleiter
- Hinterleuchtung (LCD, Handy, Schalter, Tasten, Displays, Werbebeleuchtung)
- Innen- und Außenbeleuchtung im Automobilbereich (z. B. Instrumentenbeleuchtung, Bremslichter und Blinklichter)
- Ersatz von Kleinst-Glühlampen
- Signal- und Symbolleuchten

## Features

- **package:** white P-LCC-2 package
- **feature of the device:** extremely wide viewing angle; ideal for backlighting and coupling in light guides
- **wavelength:** 633 nm (super-red), 617 nm (amber), 606 nm (orange), 587 nm (yellow)
- **viewing angle:** Lambertian Emitter (120°)
- **technology:** InGaAlP
- **optical efficiency:** 11 lm/W (yellow, orange, amber), 7 lm/W (super-red)
- **grouping parameter:** luminous intensity, wavelength
- **assembly methods:** suitable for all SMT assembly methods
- **soldering methods:** IR reflow soldering and TTW soldering
- **preconditioning:** acc. to JEDEC Level 2
- **taping:** 8-mm tape with 2000/reel, ø180 mm or 8000/reel, ø330 mm
- **ESD-withstand voltage:** up to 2 kV acc. to EOS/ESD-5.1-1993

## Applications

- traffic lights (EN 12368, only for amber ; EN 12368, ITE VTCSH part 2, for super-red, verde, yellow)
- indoor and outdoor displays (e.g. displays for traffic; light writing displays)
- optical indicators
- coupling into light guides
- backlighting (LCD, cellular phones, switches, keys, displays, illuminated advertising)
- interior and exterior automotive lighting (e.g. dashboard backlighting, brake lights, turn signal lamps, etc.)
- substitution of micro incandescent lamps
- signal and symbol luminaire

Typ	Emissions- farbe	Farbe der Lichtaustritts- fläche	Lichtstärke	Lichtstrom	Bestellnummer
Type	Color of Emission	Color of the Light Emitting Area	Luminous Intensity $I_F = 20 \text{ mA}$ $I_V \text{ (mcd)}$	Luminous Flux $I_F = 20 \text{ mA}$ $\Phi_V \text{ (mlm)}$	Ordering Code
LS T676-P1Q1-1 LS T676-Q1R2-1	super-red	colorless clear	45 ... 90 71 ... 180	190 (typ.) 350 (typ.)	Q62703-Q5096 Q62703-Q5097
LA T676-Q1R1-1 LA T676-R1S2-1	amber	colorless clear	71 ... 140 112 ... 280	310 (typ.) 560 (typ.)	Q62703-Q4982 Q62703-Q4983
LO T676-Q2R2-24 LO T676-R2S2-24	orange	colorless clear	90 ... 180 140 ... 280	390 (typ.) 610 (typ.)	Q62703-Q4405 Q62703-Q5049
LY T676-Q1R1-26 LY T676-R1S2-26	yellow	colorless clear	71 ... 140 112 ... 280	310 (typ.) 560 (typ.)	Q62703-Q5134 Q62703-Q5135

Anm.: -1 gesamter Farbbereich (siehe **Seite 4**)

-24 gesamter Farbbereich, Lieferung in Einzelgruppen (siehe **Seite 5**)

-26 gesamter Farbbereich, Lieferung in Einzelgruppen (siehe **Seite 5**)

*Die Standardlieferform von Serientypen beinhaltet eine untere bzw. eine obere Familiengruppe, die aus nur 3 bzw. 4 Halbgruppen besteht. Einzelne Halbgruppen sind nicht erhältlich.  
In einer Verpackungseinheit / Gurt ist immer nur eine Halbgruppe enthalten.*

Note: -1 Total color tolerance range (please see **page 4**)

-24 Total color tolerance range, delivery in single groups (please see **page 5**)

-26 Total color tolerance range, delivery in single groups (please see **page 5**)

*The standard shipping format for serial types includes a lower or upper family group of 3 or 4 individual groups. Individual half groups are not available.*

*No packing unit / tape ever contains more than one luminous intensity half group.*

**Grenzwerte**  
**Maximum Ratings**

Bezeichnung Parameter	Symbol Symbol	Werte Values		Einheit Unit
		LS, LO, LA	LY	
Betriebstemperatur Operating temperature range	$T_{op}$	- 40 ... + 100		°C
Lagertemperatur Storage temperature range	$T_{stg}$	- 40 ... + 100		°C
Sperrschichttemperatur Junction temperature	$T_j$	+ 125		°C
Durchlassstrom Forward current	$I_F$	30		mA
Stoßstrom Surge current $t \leq 10 \mu s, D = 0.005$	$I_{FM}$	0.8	0.2	A
Sperrspannung Reverse voltage	$V_R$	3		V
Leistungsaufnahme Power consumption	$P_{tot}$	80		mW
Wärmewiderstand Thermal resistance Sperrschicht/Umgebung Junction/ambient	$R_{th JA}$	500		K/W
Sperrschicht/Löt看pad Junction/solder point Montage auf PC-Board FR 4 (Padgröße $\geq 16 \text{ mm}^2$ ) mounted on PC board FR 4 (pad size $\geq 16 \text{ mm}^2$ )	$R_{th JS}$	280		K/W

**Kennwerte** ( $T_A = 25\text{ °C}$ )  
**Characteristics**

Bezeichnung Parameter	Symbol Symbol	Werte Values				Einheit Unit
		LS	LA	LO	LY	
Wellenlänge des emittierten Lichtes (typ.) Wavelength at peak emission $I_F = 20\text{ mA}$	$\lambda_{\text{peak}}$	645	622	610	591	nm
Dominantwellenlänge <sup>1)</sup> (typ.) Dominant wavelength $I_F = 20\text{ mA}$	$\lambda_{\text{dom}}$	633 ± 6	617 ± 6	606 +3/-6	587 +8/-7	nm
Spektrale Bandbreite bei 50 % $I_{\text{rel max}}$ (typ.) Spectral bandwidth at 50 % $I_{\text{rel max}}$ $I_F = 20\text{ mA}$	$\Delta\lambda$	16	16	16	15	nm
Abstrahlwinkel bei 50 % $I_V$ (Vollwinkel) (typ.) Viewing angle at 50 % $I_V$	$2\phi$	120	120	120	120	Grad deg.
Durchlassspannung <sup>2)</sup> (typ.) Forward voltage (max.) $I_F = 20\text{ mA}$	$V_F$ $V_F$	2.0 2.4	2.0 2.4	2.0 2.4	2.0 2.4	V V
Sperrstrom (typ.) Reverse current (max.) $V_R = 3\text{ V}$	$I_R$ $I_R$	0.01 10	0.01 10	0.01 10	0.01 10	$\mu\text{A}$ $\mu\text{A}$
Temperaturkoeffizient von $\lambda_{\text{peak}}$ (typ.) Temperature coefficient of $\lambda_{\text{peak}}$ $I_F = 20\text{ mA}; -10\text{ °C} \leq T \leq 100\text{ °C}$	$TC_{\lambda_{\text{peak}}}$	0.14	0.13	0.13	0.13	nm/K
Temperaturkoeffizient von $\lambda_{\text{dom}}$ (typ.) Temperature coefficient of $\lambda_{\text{dom}}$ $I_F = 20\text{ mA}; -10\text{ °C} \leq T \leq 100\text{ °C}$	$TC_{\lambda_{\text{dom}}}$	0.01	0.06	0.07	0.10	nm/K
Temperaturkoeffizient von $V_F$ (typ.) Temperature coefficient of $V_F$ $I_F = 20\text{ mA}; -10\text{ °C} \leq T \leq 100\text{ °C}$	$TC_V$	-2.0	-1.8	-1.7	-2.5	mV/K
Optischer Wirkungsgrad (typ.) Optical efficiency $I_F = 20\text{ mA}$	$\eta_{\text{opt}}$	7	11	11	11	lm/W

<sup>1)</sup> Wellenlängengruppen werden mit einer Stromeinprägedauer von 25 ms und einer Genauigkeit von  $\pm 1\text{ nm}$  ermittelt.  
Wavelength groups are tested at a current pulse duration of 25 ms and a tolerance of  $\pm 1\text{ nm}$ .

<sup>2)</sup> Spannungswerte werden mit einer Stromeinprägedauer von 1 ms und einer Genauigkeit von  $\pm 0,1\text{ V}$  ermittelt.  
Voltages are tested at a current pulse duration of 1 ms and a tolerance of  $\pm 0.1\text{ V}$ .

1) Wellenlängengruppen / Wavelength groups

Gruppe Group	yellow		orange		Einheit Unit
	min.	max.	min.	max.	
2	580	583	600	603	nm
3	583	586	603	606	nm
4	586	589	606	609	nm
5	589	592			nm
6	592	595			nm

**Helligkeits-Gruppierungsschema**  
**Luminous Intensity Groups**

Lichtgruppe Luminous Intensity Group	Lichtstärke Luminous Intensity $I_V$ (mcd)	Lichtstrom Luminous Flux $\Phi_V$ (mlm)
P1	45 ... 56	150 (typ.)
P2	56 ... 71	190 (typ.)
Q1	71 ... 90	240 (typ.)
Q2	90 ... 112	300 (typ.)
R1	112 ... 140	380 (typ.)
R2	140 ... 180	480 (typ.)
S1	180 ... 224	600 (typ.)
S2	224 ... 280	760 (typ.)
T1	280 ... 355	950 (typ.)

Helligkeitswerte werden mit einer Stromeinprägedauer von 25 ms und einer Genauigkeit von  $\pm 11\%$  ermittelt.  
Luminous intensity is tested at a current pulse duration of 25 ms and a tolerance of  $\pm 11\%$ .

**Gruppenbezeichnung auf Etikett**  
**Group Name on Label**

Beispiel: S2-3

Example: S2-3

Lichtgruppe Luminous Intensity Group	Halbgruppe Half Group	Wellenlänge Wavelength
S	2	3

Relative spektrale Emission  $I_{rel} = f(\lambda)$ ,  $T_A = 25\text{ °C}$ ,  $I_F = 20\text{ mA}$

**Relative Spectral Emission**

$V(\lambda)$  = spektrale Augenempfindlichkeit

Standard eye response curve

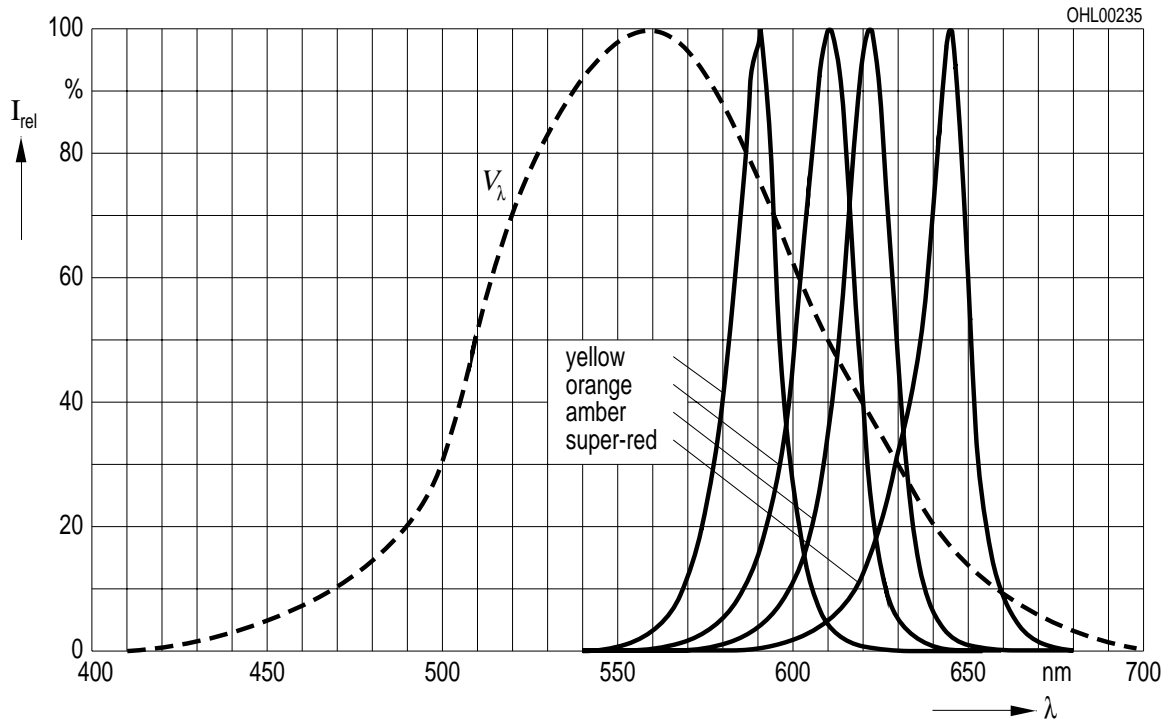

Abstrahlcharakteristik  $I_{rel} = f(\varphi)$

**Radiation Characteristic**

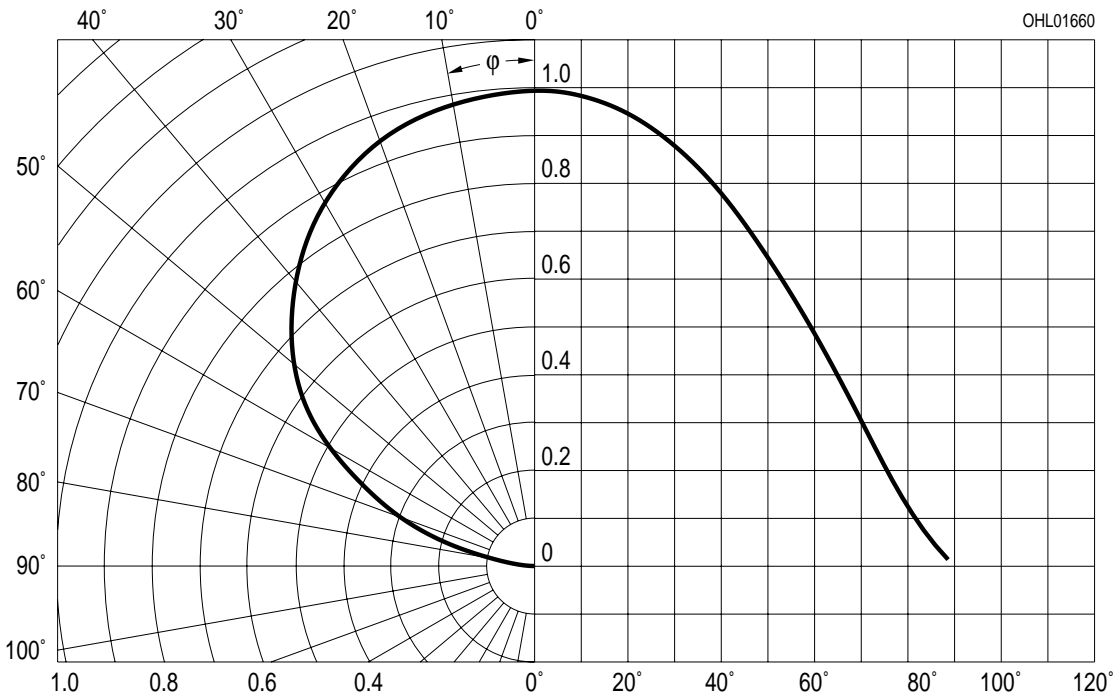

**Durchlassstrom  $I_F = f(V_F)$**   
**Forward Current**

$T_A = 25\text{ }^\circ\text{C}$

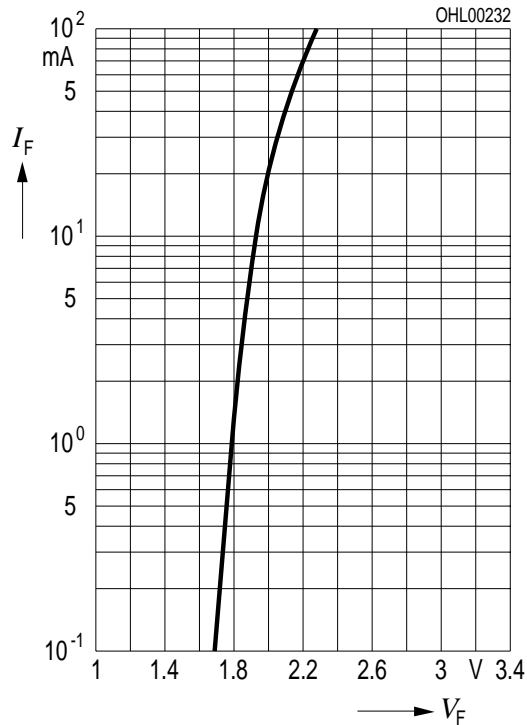

**Relative Lichtstärke  $I_V/I_{V(20\text{ mA})} = f(I_F)$**   
**Relative Luminous Intensity**

$T_A = 25\text{ }^\circ\text{C}$

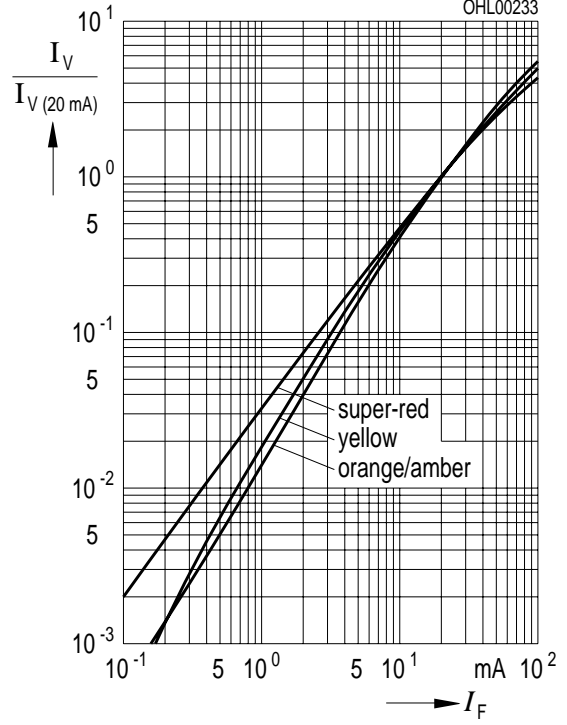

**Maximal zulässiger Durchlassstrom  $I_F = f(T)$**   
**Max. Permissible Forward Current**

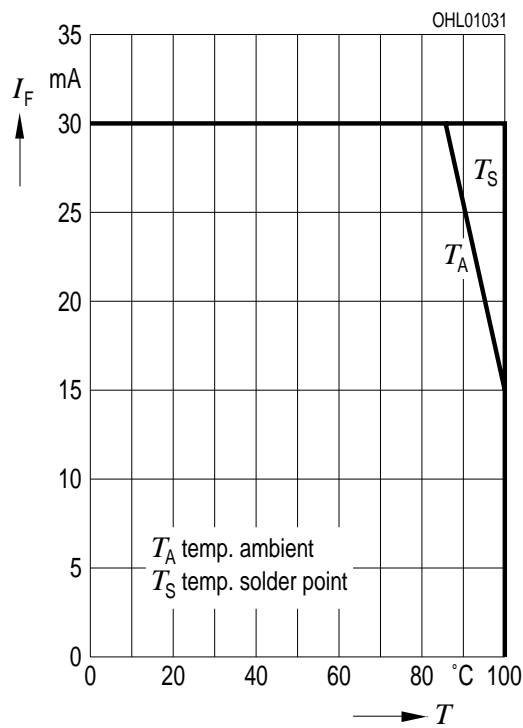

**Relative Lichtstärke  $I_V/I_{V(25\text{ }^\circ\text{C})} = f(T_A)$**   
**Relative Luminous Intensity**

$I_F = 20\text{ mA}$

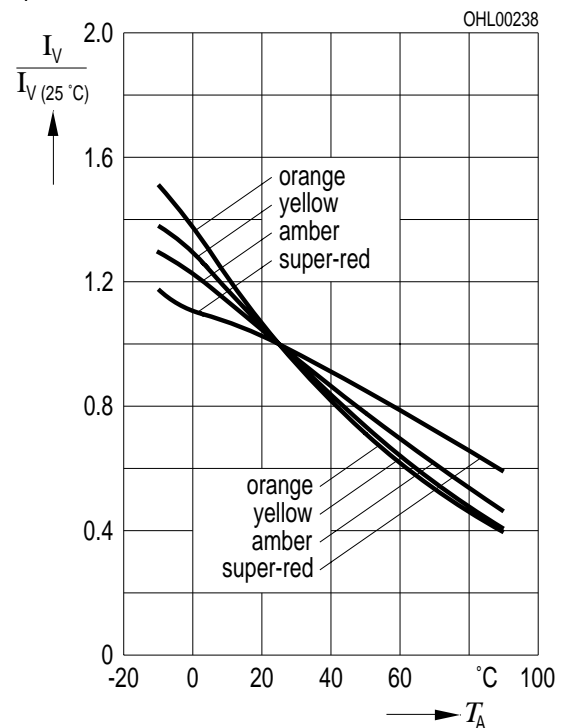

**Zulässige Impulsbelastbarkeit  $I_F = f(t_p)$**   
**Permissible Pulse Handling Capability**  
 Duty cycle  $D =$  parameter,  $T_A = 25\text{ °C}$   
**LS, LA, LO**

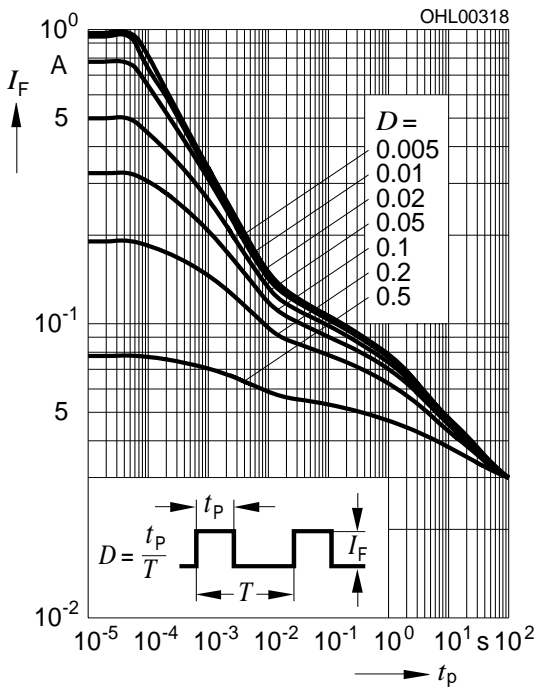

**Zulässige Impulsbelastbarkeit  $I_F = f(t_p)$**   
**Permissible Pulse Handling Capability**  
 Duty cycle  $D =$  parameter,  $T_A = 85\text{ °C}$   
**LS, LA, LO**

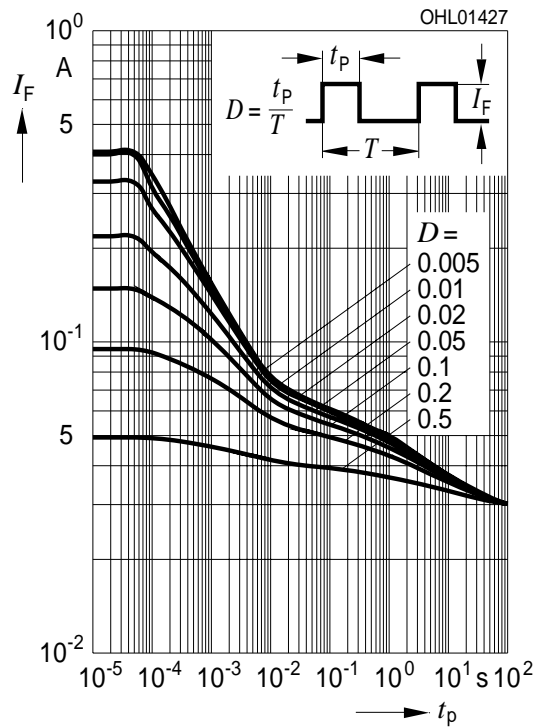



**Zulässige Impulsbelastbarkeit  $I_F = f(t_p)$**   
**Permissible Pulse Handling Capability**  
 Duty cycle  $D =$  parameter,  $T_A = 25\text{ °C}$   
**LY**

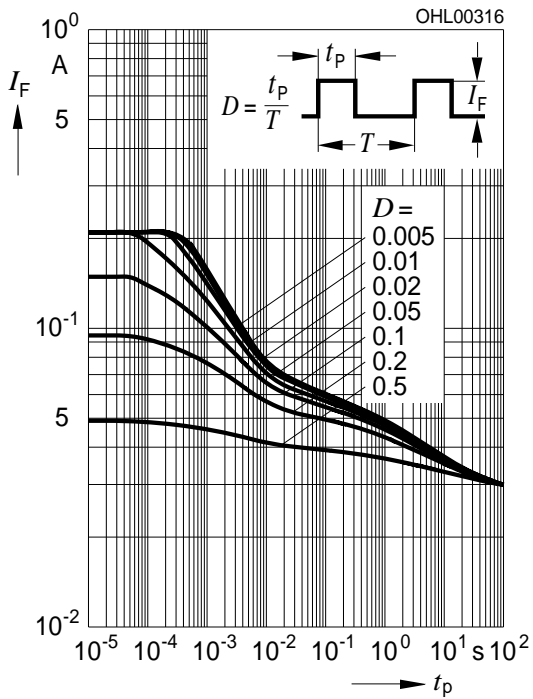

**Zulässige Impulsbelastbarkeit  $I_F = f(t_p)$**   
**Permissible Pulse Handling Capability**  
 Duty cycle  $D =$  parameter,  $T_A = 85\text{ °C}$   
**LY**

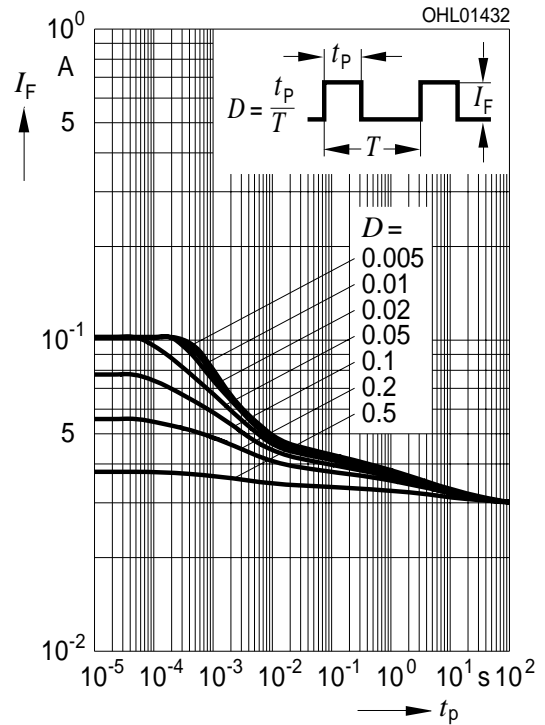

**Maßzeichnung**  
**Package Outlines**

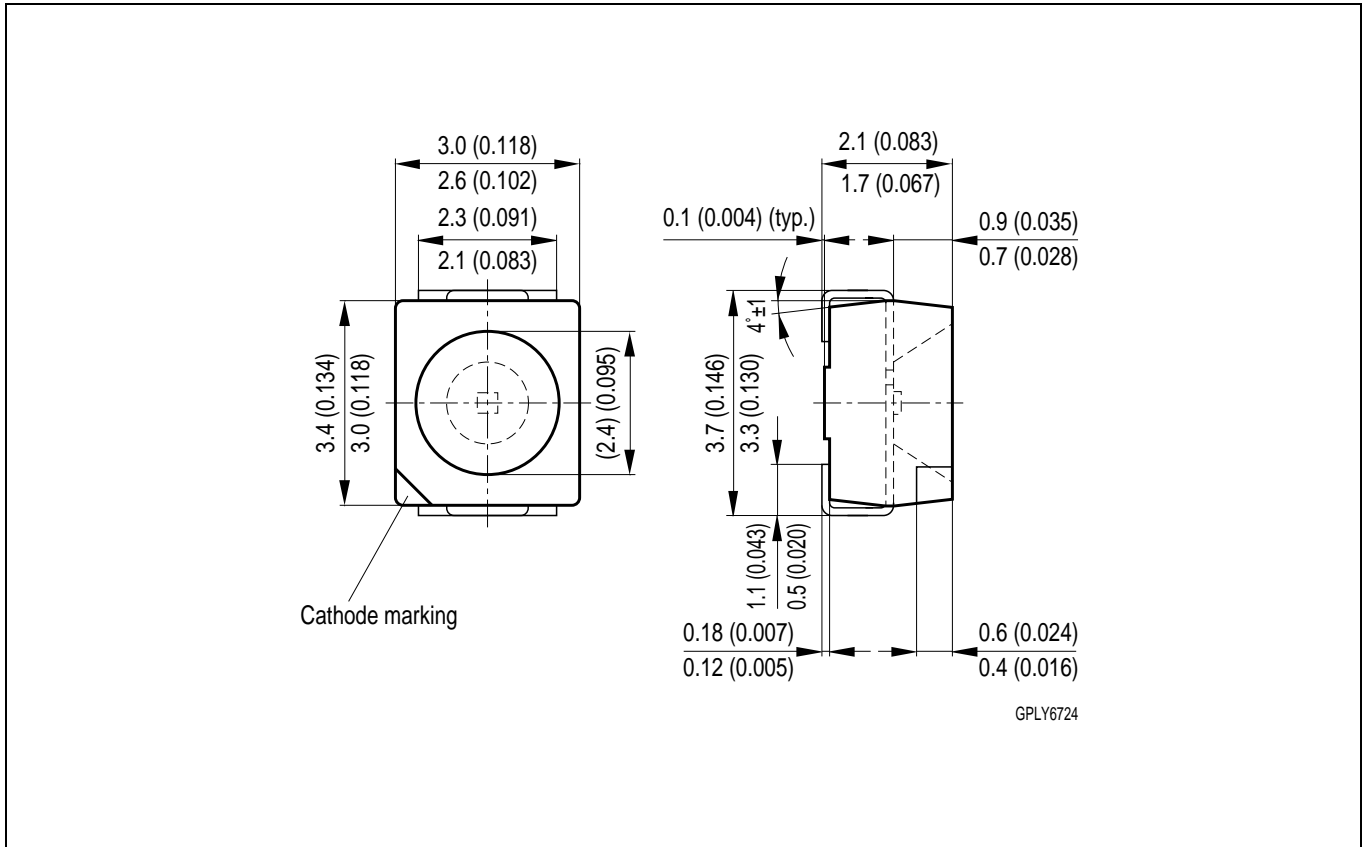

Maße werden wie folgt angegeben: mm (inch) / Dimensions are specified as follows: mm (inch).

**Kathodenkennung:** abgeschrägte Ecke  
**Cathode mark:** bevelled edge  
**Gewicht / Approx. weight:** 40 mg

**Lötbedingungen** Vorbehandlung nach JEDEC Level 2  
**Soldering Conditions** Preconditioning acc. to JEDEC Level 2

**IR-Reflow Lötprofil** (nach IPC 9501)  
**IR Reflow Soldering Profile** (acc. to IPC 9501)

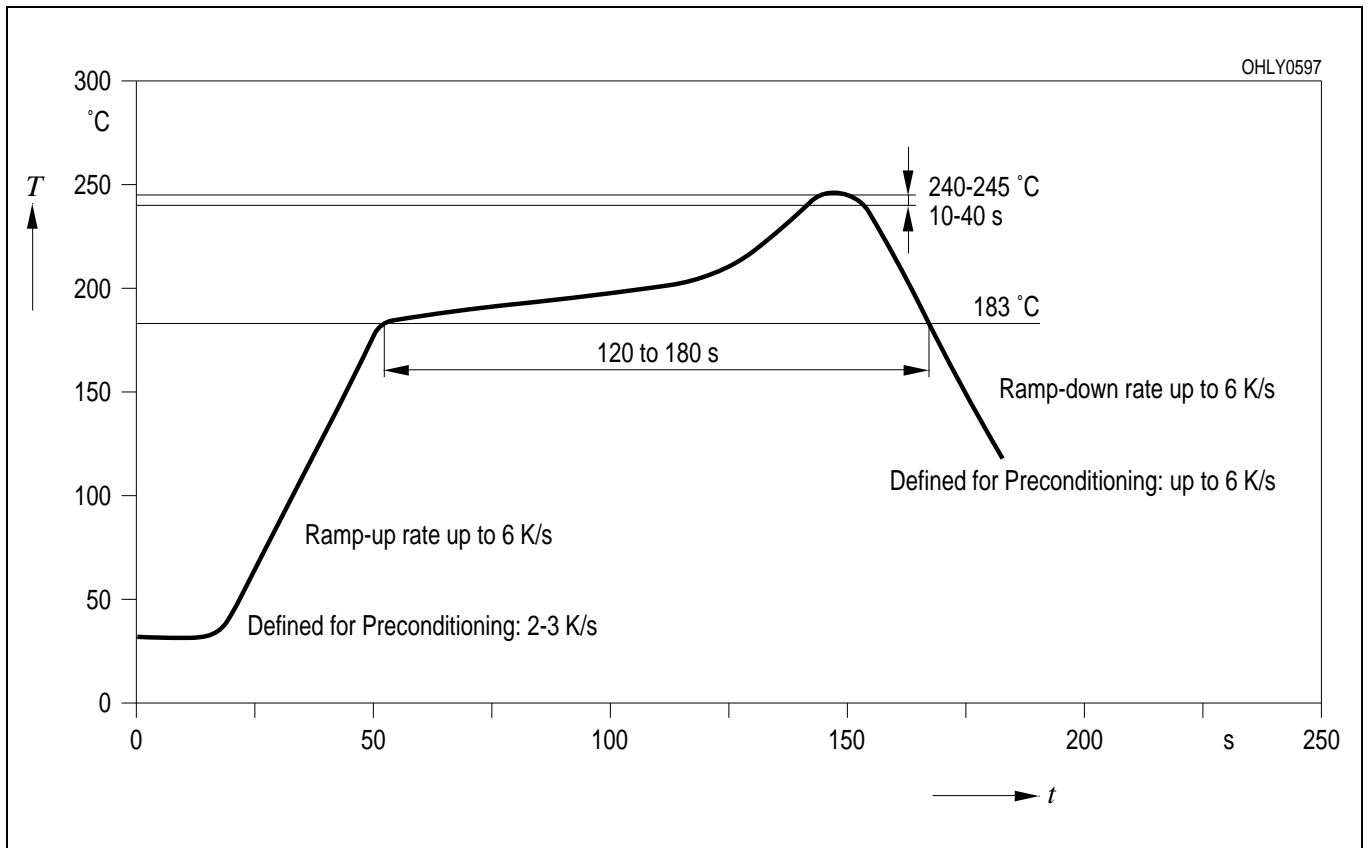

**Wellenlöten (TTW)** (nach CECC 00802)  
**TTW Soldering** (acc. to CECC 00802)

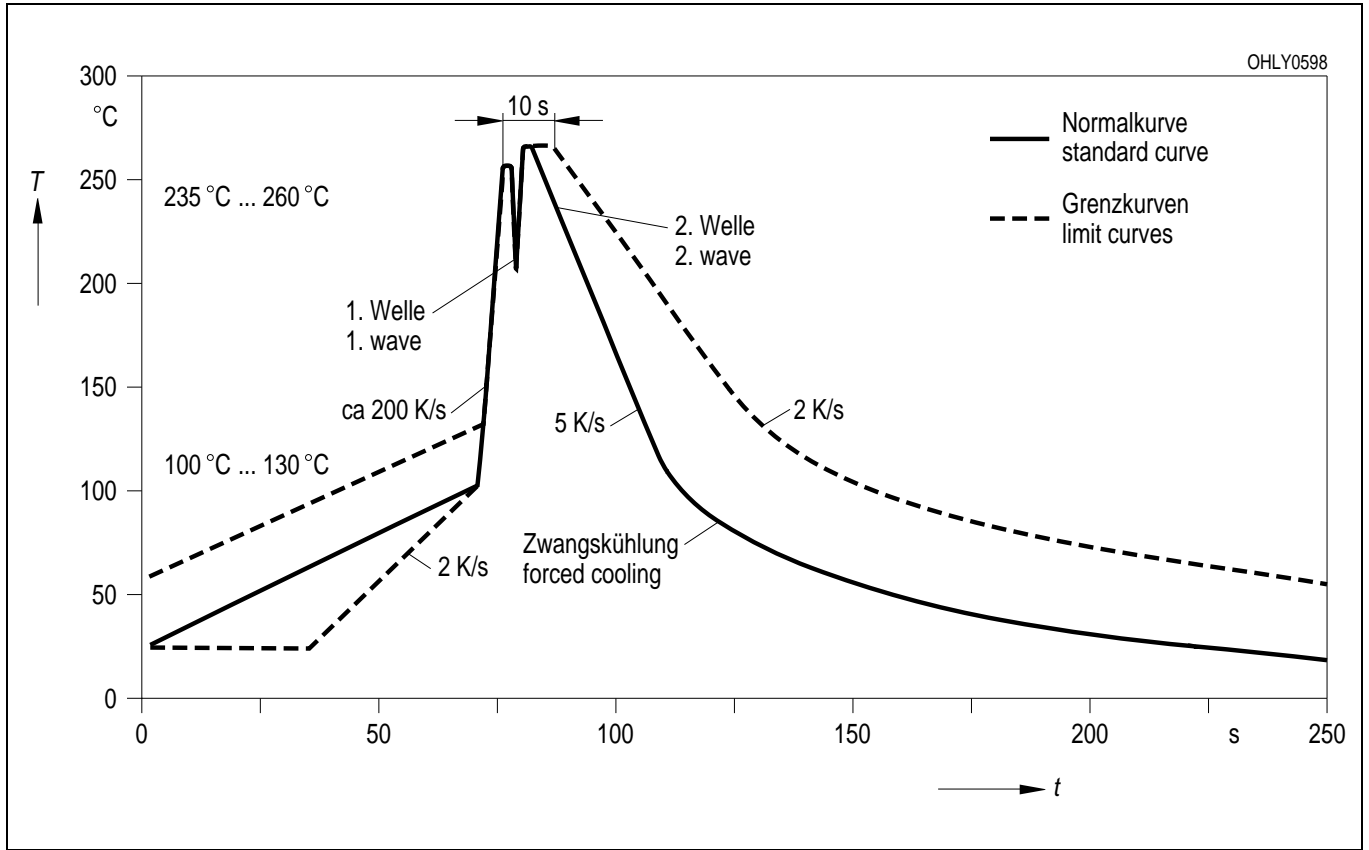

**Empfohlenes Lötpad Design** IR-Reflow Löten / Wellenlöten (TTW)  
**Recommended Solder Pad** IR Reflow Soldering / TTW Soldering

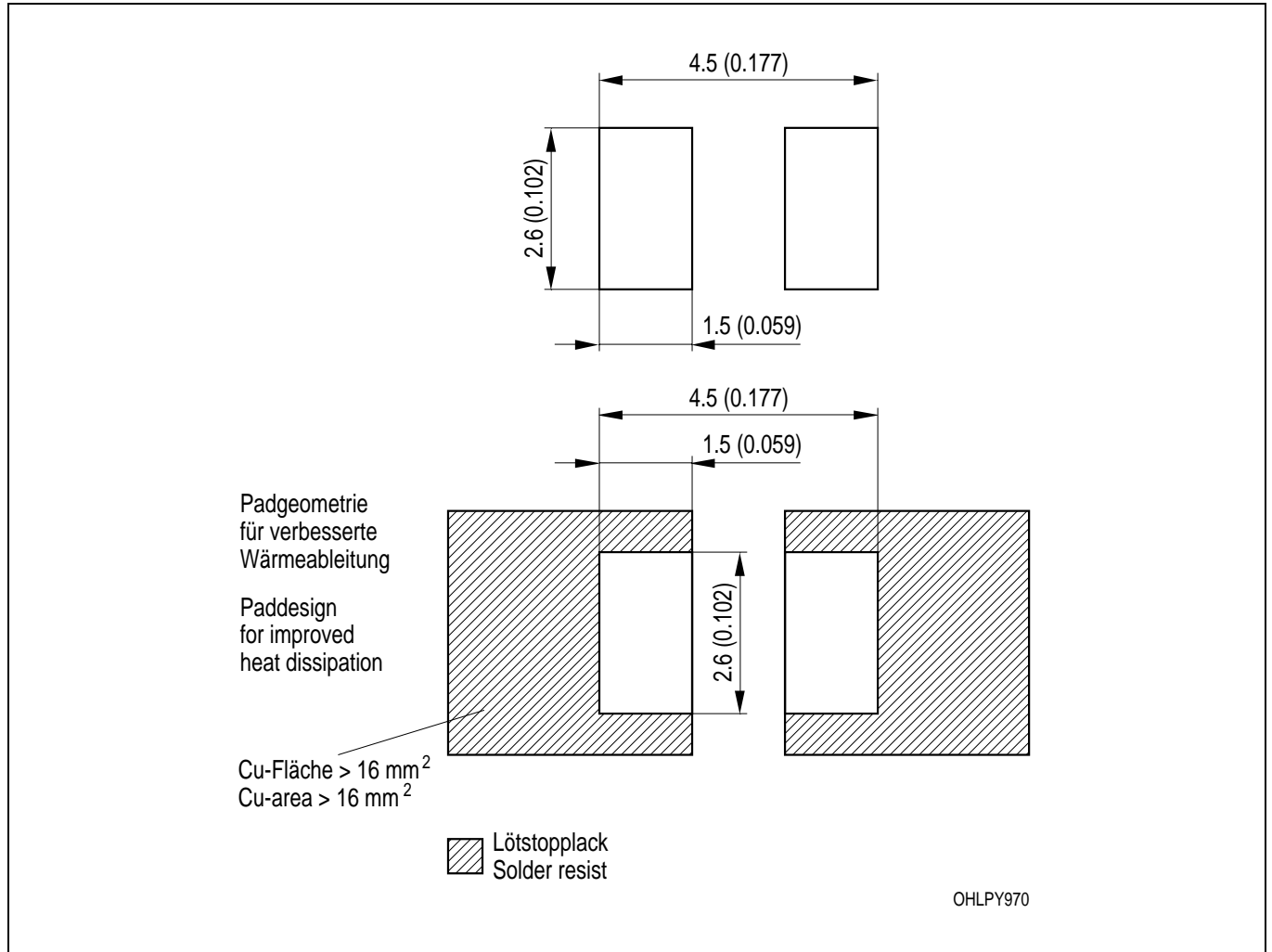

Maße werden wie folgt angegeben: mm (inch) / Dimensions are specified as follows: mm (inch)

**Gurtung / Polarität und Lage**

Verpackungseinheit 2000/Rolle, ø180 mm  
oder 8000/Rolle, ø330 mm

**Method of Taping / Polarity and Orientation**

Packing unit 2000/reel, ø180 mm  
or 8000/reel, ø330 mm

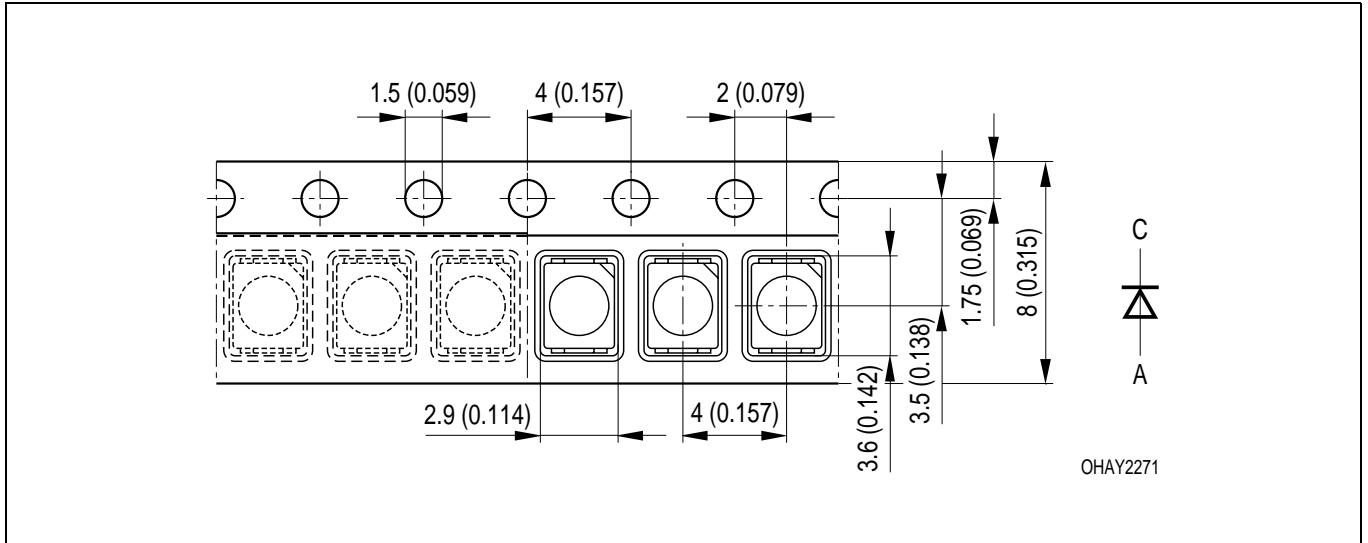

Maße werden wie folgt angegeben: mm (inch) / Dimensions are specified as follows: mm (inch)

---

**Revision History: 2002-05-16**

Previous Version: 2001-11-26

Page	Subjects (major changes since last revision)
4	Value (wavelength amber)
5	New wavelength grouping
1	Insert of ESD-withstand voltage
2	wavelength grouping for yellow and orange

**Published by OSRAM Opto Semiconductors GmbH & Co. OHG**  
**Wernerwerkstrasse 2, D-93049 Regensburg**  
**© All Rights Reserved.**

**Attention please!**

The information describes the type of component and shall not be considered as assured characteristics. Terms of delivery and rights to change design reserved. Due to technical requirements components may contain dangerous substances. For information on the types in question please contact our Sales Organization. If printed or downloaded, please find the latest version in the Internet.

**Packing**

Please use the recycling operators known to you. We can also help you – get in touch with your nearest sales office. By agreement we will take packing material back, if it is sorted. You must bear the costs of transport. For packing material that is returned to us unsorted or which we are not obliged to accept, we shall have to invoice you for any costs incurred.

**Components used in life-support devices or systems must be expressly authorized for such purpose!** Critical components <sup>1</sup> may only be used in life-support devices or systems <sup>2</sup> with the express written approval of OSRAM OS.

<sup>1</sup> A critical component is a component used in a life-support device or system whose failure can reasonably be expected to cause the failure of that life-support device or system, or to affect its safety or the effectiveness of that device or system.

<sup>2</sup> Life support devices or systems are intended (a) to be implanted in the human body, or (b) to support and/or maintain and sustain human life. If they fail, it is reasonable to assume that the health of the user may be endangered.