



Eveready Battery Company, Inc.

533 Maryville University Drive
 St. Louis, MO 63141
 Telephone 1-800-383-7323
 Internet: www.energizer.com

Engineering Data

D
Alkaline 1.5V
 No Added Mercury or Cadmium

ENERGIZER NO. E95

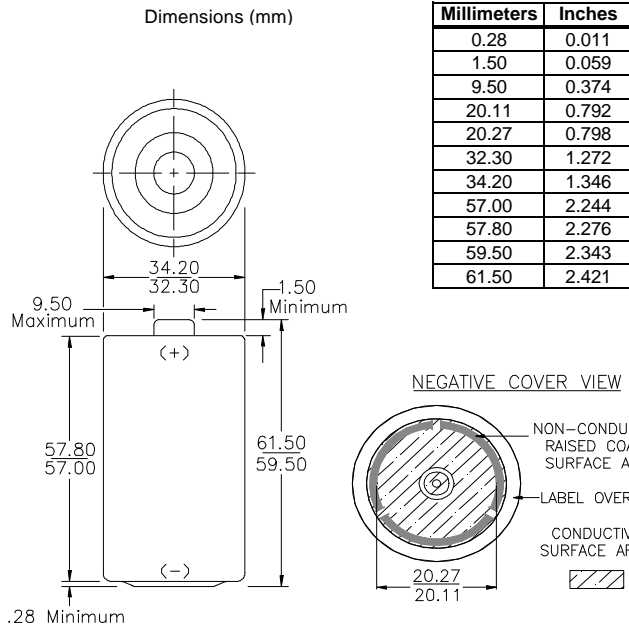

Chemical System: Zinc-Manganese Dioxide (Zn/MnO₂)

Designation: ANSI-13A, IEC-LR20

Battery Voltage: 1.5 Volts

Average Weight: 141.9 grams (5.0 oz.)

Volume: 55.9 cubic centimeters (3.4 cubic inch)

Average Service capacity (to 0.8 Volts / cell): 18000 mAh
 (Rated Capacity at 25 mA continuous drain)

Cell: One No. 3-350 (size "D")

Jacket: Plastic Label

Shelf Life: 7 years

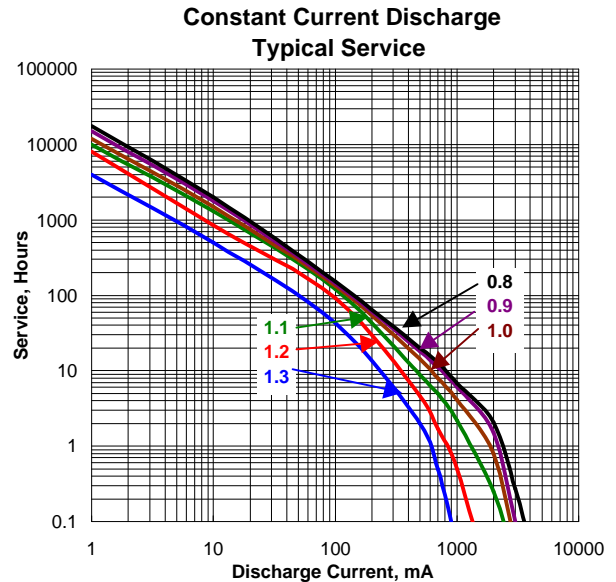
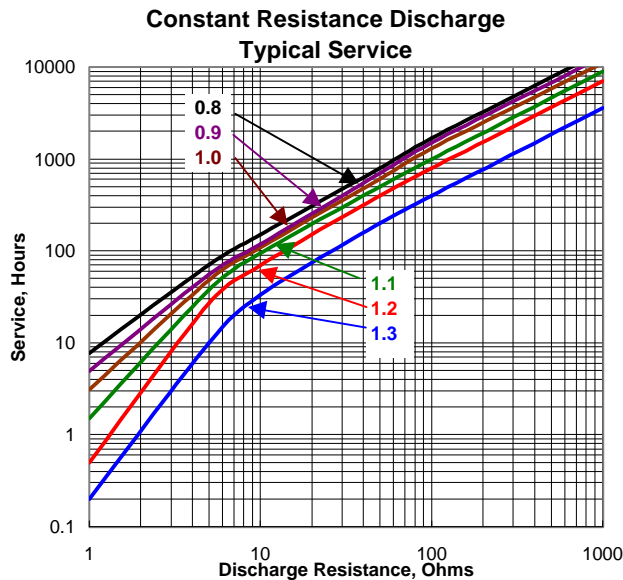
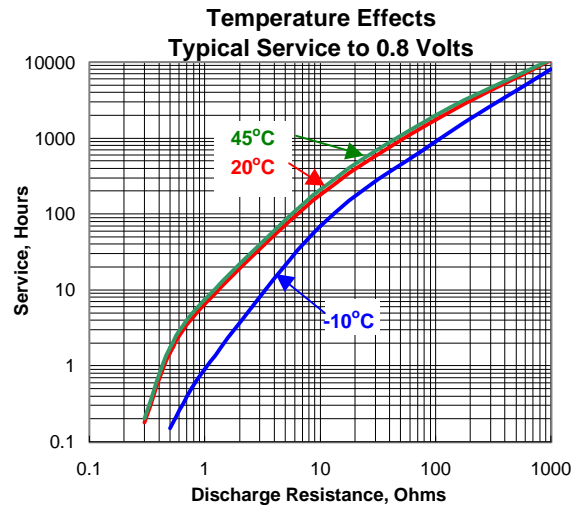

ENERGIZER NO. E95

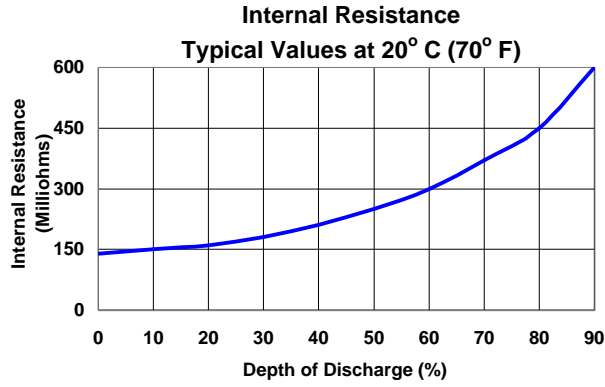

Typical Applications

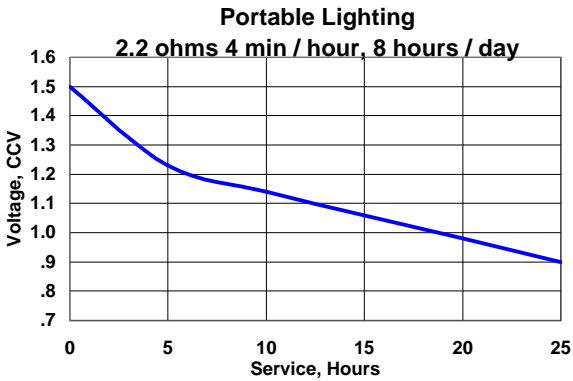
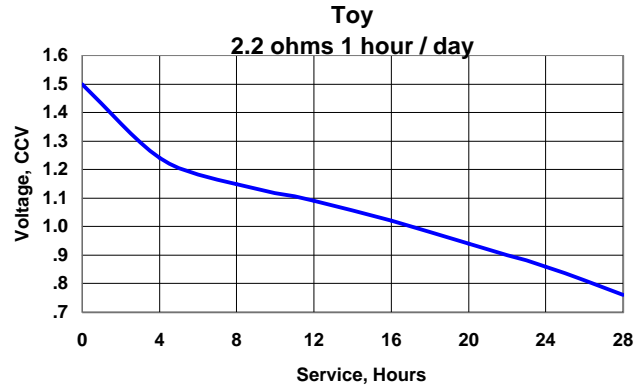
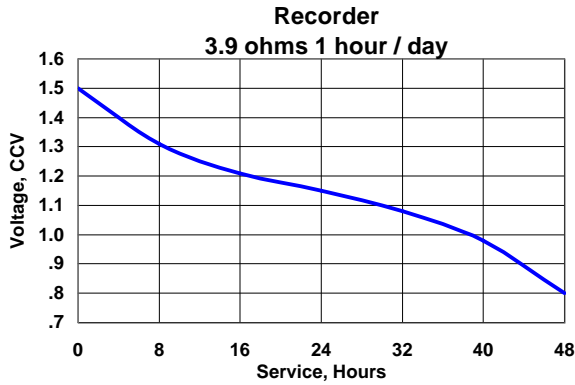
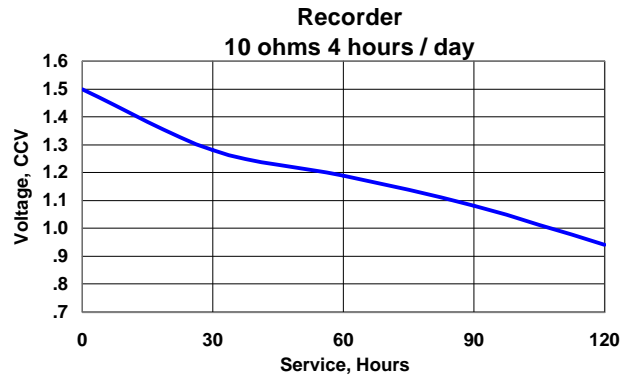
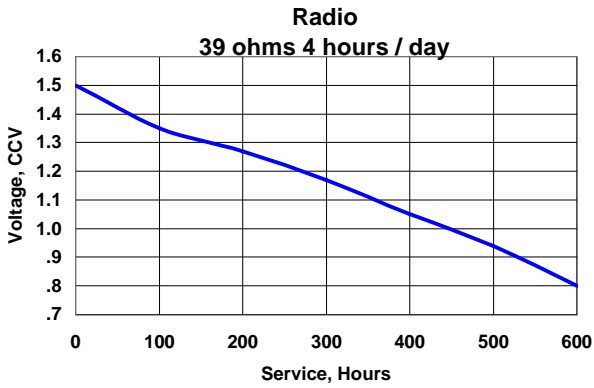

Important Notice

This data sheet contains information specific to batteries manufactured at time of its publication. Please contact your Energizer representative for most current information. Contents herein do not constitute a warranty.