

Accessories, Rittal Uniset® *iS*/Rittal Varioset *iS*

Accessories

Card Guides in Card Frames

Technical Description:

Polycarbonate UL 94-VO

- suitable for PCB thicknesses from 1.6 - 2.2 mm
- for screw fixing (additional fixing screws 360637 and tapped strips must be ordered)

One-piece units

for PCBs	Packs of	Model No.
160 mm	10	360670
220 mm	10	360672

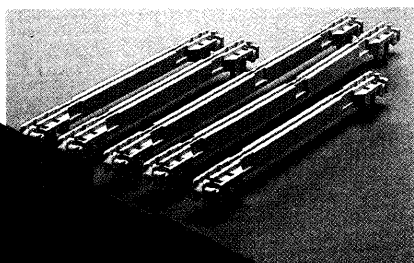

Three-piece units

for PCBs	Packs of	Model No.
160 mm	10	360673
220 mm	10	360674

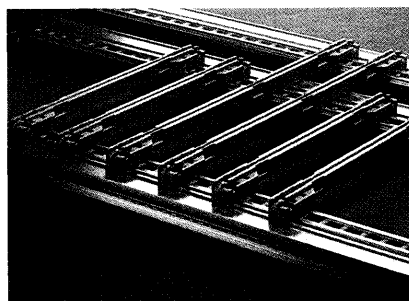
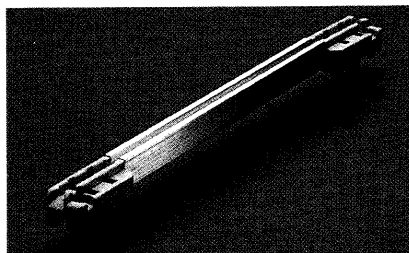

Centre Section for Three-Piece Card-Guides

Material:

Aluminium, alocrom (conductive)

Packs of	Model No.
1 x 1 m	360676

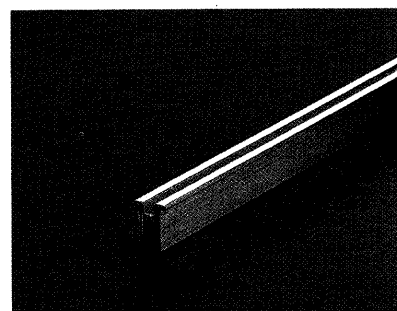

Head Sections for Three-Piece Card Guides

Material:

Polycarbonate UL 94-VO

Packs of	Model No.
10 pairs	360675

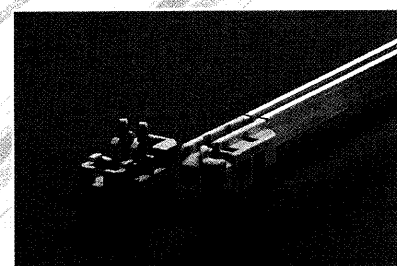

Card Guide Supports

Technical Description:

Polycarbonate UL 94-VO

- suitable for PCB thicknesses from 1.6 - 2.2 mm
- 11 plug-in locations in 4 E pitch pattern

for PCBs	Packs of	Model No.
160 mm	2	360677
220 mm	2	360678

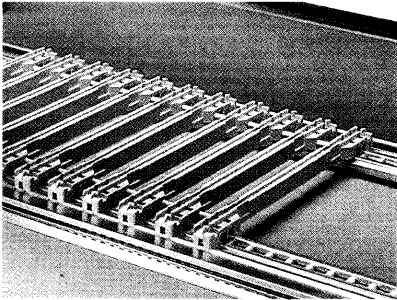

Card Retainer

For retention of individual PCBs; is snapped into card guide retro-spectively.

Material:

Polycarbonate UL 94-VO

Packs of	Model No.
10	360711

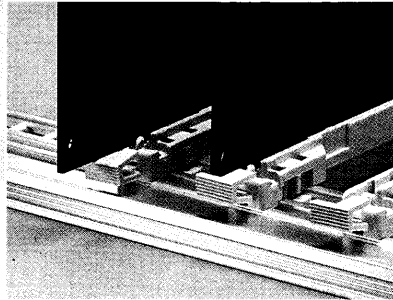

Insulating Strip

For use with bus boards.

Material:

Polypropylene MV 40

Length	Packs of	Model No.
84 E	2	360485

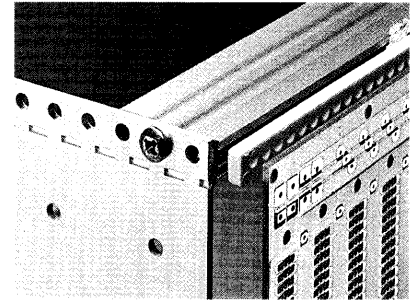

Card Guides in Modules

For use in connection with cover plates for modules (see page 23).

Material:

Noryl

for PCBs	Packs of	Model No.
160 mm	10	360614
220 mm	10	360620

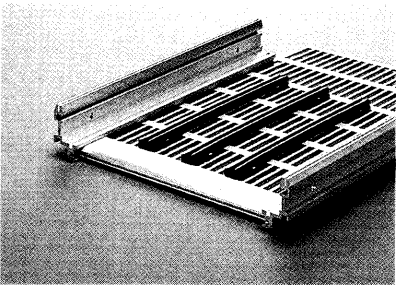

Tapped Strips

Tapped holes M 2.5 in 1 TE pitch pattern.

Material:

Steel, chrome plated

Usable E	Packs of	Model No.
14	2	360413
21	2	360420
28	2	360427
40	2	360440
42	2	360441
84	2	360483

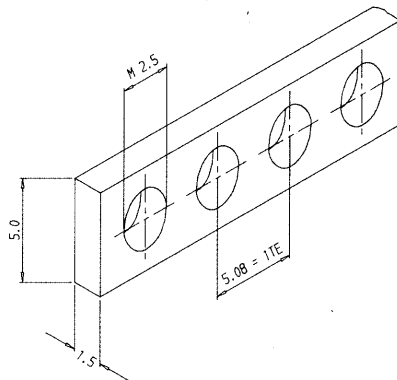
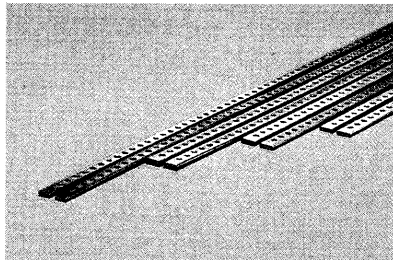

TE Strip

For positioning the card guides in the cross rail.

Material:

Polycarbonate UL 94-VO

Length	Packs of	Model No.
42 E	4	360494
84 E	4	360495

