



(W)
White



(B)
Black



(PW)
Pearl White

Standard Detection - 5m



(W)
White



(B)
Black



(PW)
Pearl White

Long Distance Detection - 12m

FEATURES

1 μ A low current consumption with Panasonic's proprietary design

Development of a specialized circuit allows the reduction of current consumption to 1 μ A (during sleep mode). When motion is detected, the sensor will shift to "stand-by" mode.

Reduction of current consumption allows battery life to be extended for battery driven products, including wireless based and low power consumption devices. (Product lineup includes 1 μ A, 2 μ A, and 6 μ A sensors.)

Simplified circuitry with fully integrated sensor design

Panasonic's proprietary high-density embedded circuit design eliminates external sensing circuits. Advantages include reduced development and design schedules.

Robust design prevents false detection

PaPIRS sensing circuits are enclosed in a metallic can to minimize adverse effects of external electromagnetic fields. Examples include radiated noise caused by cellular phones.

A high S/N ratio minimizes sensitivity to false tripping when operated under various environmental conditions.

Low curvature lens for product designs

Panasonic's lens formation technology achieves a semi-flat lens with a smooth surface and minimum protrusion from the device (lens diameter: ϕ 9.5mm).

In addition to white and black lens options, pearl white is offered for design aesthetics.

(※Refer to "Dimensions" on page 5)

Lead-free pyroelectric elements

PaPIRS sensing elements contain lithium tantalate and are lead-free. Typical PIR sensing elements are ferroelectric ceramic (PZT) containing lead.

APPLICATIONS

Security Equipment:

- Wireless security sensors, and cameras

Wireless Devices / Mobile Equipment:

- Wireless occupancy sensors (powered by PV cells or battery)
- PC and smart phone
- Commercial & Residential Lighting Fixtures
- Video Intercoms
- Vending Machines
- Home Automation

What is passive infrared type?

This sensor detects changes in infrared radiation that occur when there is movement by a person (or object) which is different in temperature from the surroundings.

- 1 As this sensor detects temperature differences, it is well suited to detecting the motion of people by their body temperature.
- 2 Wide sensing area.

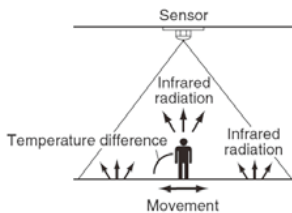

Compliance with RoHS Directive

Block Diagram (Digital output circuit)

Built-in amplifier and comparator connected directly to a microcomputer.

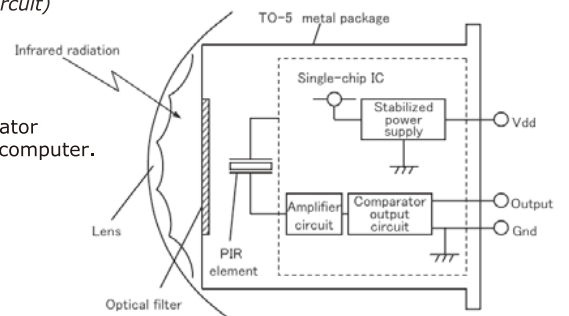

EKMB

Output: **1:** Digital

Current Consumption: **1:** 1 μ A, **2:** 2 μ A, **3:** 6 μ A

Detection Performance: **01:** Standard Detection: 5m
03: Long Distance Detection: 12m

Lens Color:
1: White **2:** Black **3:** Pearl White

Lens Material: **1:** Polyethylene

Mounting: **1:** TO-5

PRODUCT TYPES

| Detection Performance | Current Consumption | Lens Color | Model No. | Inner Package | Outer Package |
|--------------------------------|---------------------|-------------|-------------|---------------|---------------|
| Standard Detection 5m | 1 μ A | White | EKMB1101111 | 50pcs | 1000pcs |
| | | Black | EKMB1101112 | | |
| | | Pearl White | EKMB1101113 | | |
| | 2 μ A | White | EKMB1201111 | | |
| | | Black | EKMB1201112 | | |
| | | Pearl White | EKMB1201113 | | |
| | 6 μ A | White | EKMB1301111 | | |
| | | Black | EKMB1301112 | | |
| | | Pearl White | EKMB1301113 | | |
| Long Distance Detection 12m | 1 μ A | White | EKMB1103111 | 50pcs | 1000pcs |
| | | Black | EKMB1103112 | | |
| | | Pearl White | EKMB1103113 | | |
| | 2 μ A | White | EKMB1203111 | | |
| | | Black | EKMB1203112 | | |
| | | Pearl White | EKMB1203113 | | |
| | 6 μ A | White | EKMB1303111 | | |
| | | Black | EKMB1303112 | | |
| | | Pearl White | EKMB1303113 | | |

PRODUCT TYPES

1. Detection Performance [Conditions for measuring: Ambient temperature: 25°C(77°F) Operating voltage: 3VDC]

| Items | | Standard Detection 5m | Long Distance Detection - 12m | Conditions concerning target |
|---------------------|----------------|--------------------------|----------------------------------|--|
| Detection Range *1) | | Max. 5m | Max. 12m | 1. The temperature difference between the target and the surroundings should be superior to 4°C (7.2°F). 2. Movement speed: 1.0m/s 3. Target concept is human body (Size: 700 × 250mm) |
| Detection Area | Horizontal *2) | 94° (±47°) | 102° (±51°) | |
| | Vertical *2) | 82° (±41°) | 92° (±46°) | |
| Detection Zone *3) | | 64 zones | 92 zones | |

*1) Depending on the target's speed and temperature difference compared to the surroundings, detection can occur at a range superior to the above value. Please use this sensor according to the specifications for guaranteed performance.

*2) Definitions for "Horizontal" and "Vertical"

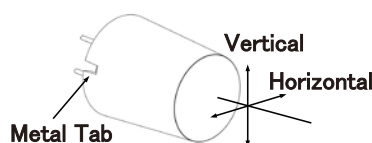

Standard detection type

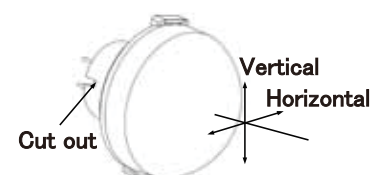

Long Distance detection type

*3) Refer to the "detection area" diagram on P.4.

2. Maximum Rated Values

| Items | Specified value |
|----------------------------|--|
| Power Supply Voltage | -0.3~4.5V DC |
| Usable Ambient Temperature | -20~+60°C (-4~+140°F) Do not use in a freezing or condensation environment. |
| Storage Temperature | -20~+70°C (-4~+158°F) |

3. Electrical Characteristic [Conditions for Measuring: Ambient temperature 25°C(77°F)]

| Items | Symbol | 1 μ A type | 2 μ A type | 6 μ A type | Measured Conditions |
|--|--------|-----------------|----------------|----------------|---------------------|
| Operating Voltage | Min. | 2.3V DC | 2.3V DC | 2.3V DC | — |
| | Max. | 4.0V DC | 4.0V DC | 4.0V DC | — |
| Electrical Current Consumption (Sleep mode) (*4) | Avg. | 1.0 μ A | — | — | Iout=0 |
| | Max. | 1.6 μ A | — | — | |
| Electrical Current Consumption (Standby mode) (*4) | Avg. | 1.9 μ A | 1.9 μ A | 6.0 μ A | Iout=0 |
| | Max. | 3.0 μ A | 3.0 μ A | 12.0 μ A | |
| Output Current | Max. | Iout | 100 μ A | 100 μ A | Vout \geq Vdd-0.5 |
| Output Voltage | Min. | Vout | Vdd-0.5VDC | Vdd-0.5VDC | Vdd-0.5VDC |
| Circuit Stability Time (When voltage is applied) | Avg. | T _{wu} | 25s | 25s | — |
| | Max. | T _{wu} | 210s | 210s | 30s |

(*4)(*5): "Sleep mode" or "Standby mode" is for 1 μ A current consumption version. Please refer to "TIMING CHART" below.

TIMING CHART

1. Digital output (1 μ A current consumption)

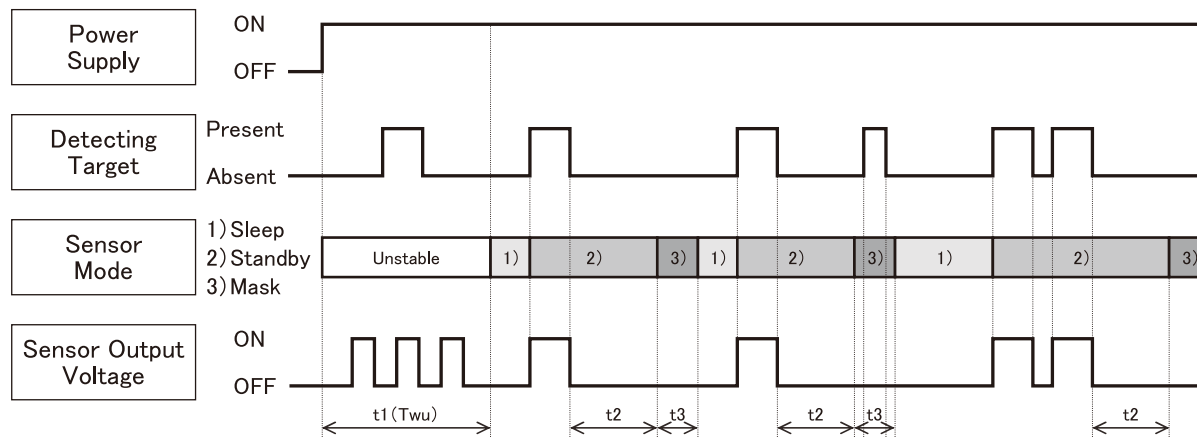

[Modes]

- 1) Sleep Mode : When the output is OFF. The electrical current consumption is approximately 1 μ A.
- 2) Standby Mode : After the sensor's output reaches ON status, the sensor switches to standby mode. The electrical current consumption is ~ 1.9 μ A. When the sensor's output returns to an OFF value after expiration of the "hold time", the sensor switches again to sleep mode.
- 3) Mask Mode : Time during which the output is forced to OFF after the end of the standby mode. (no detection is possible during this period.)

[Durations]

- t1(T_{wu}): Circuit Stability Time: ~ 25s (typ.)
During this stage, the output's status is undefined (ON/OFF) and detection is not guaranteed.
- t2 : Standby Hold Time: ~ 2.6s (typ.)
Depending on the number of output occurrences during standby mode, the hold time can differ (※1)
- t3 : Mask Time ~ 1.3s (typ.)
During this stage, even if the sensor detects something, output will not switch ON.(※2)

2. Digital Output (2 μ A and 6 μ A current consumption)

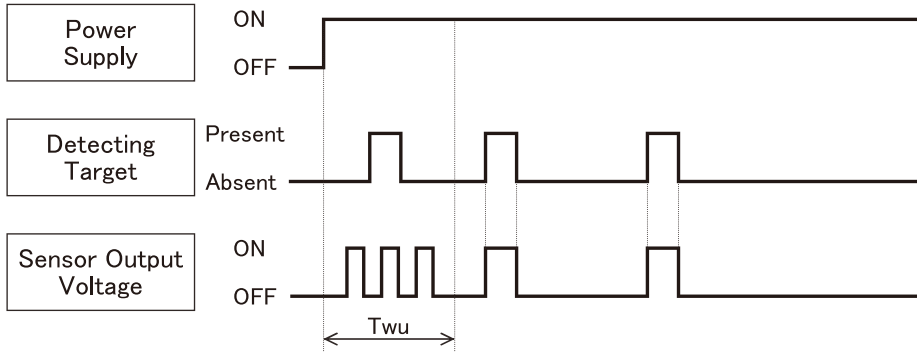

[Durations]

Twu: Circuit Stability Time (2 μ A): ~ 25s (typ.)
 Circuit Stability Time (6 μ A): ~ 30s (max.)
 During this stage, output status is undefined (ON/OFF) and detection is not guaranteed.

DETECTION PERFORMANCE

1) Standard detection type

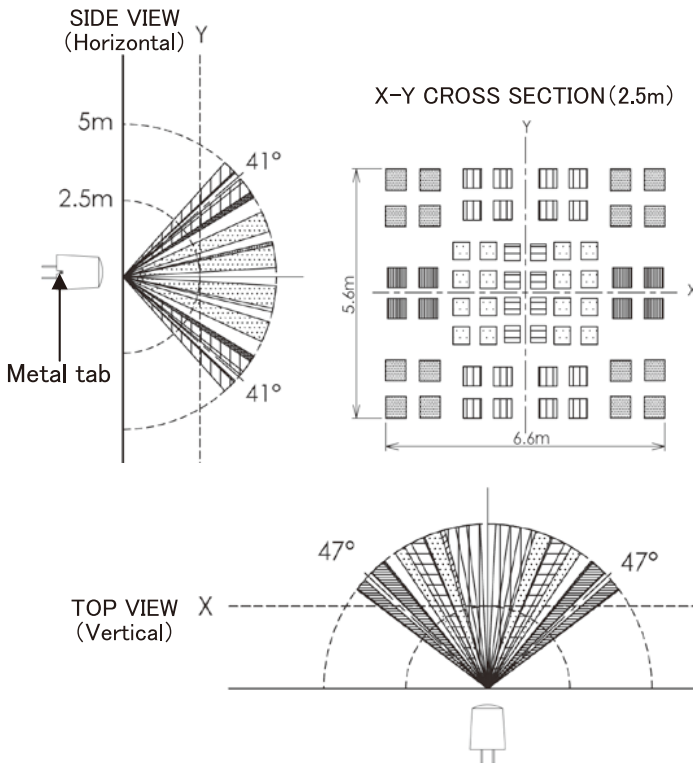

2) Long Distance detection type

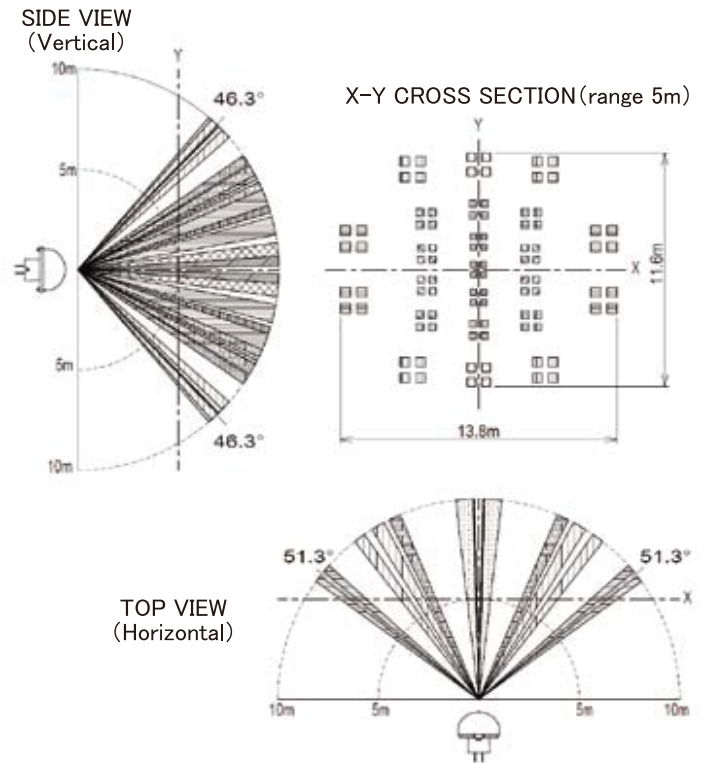

2. Detection Zone Notes

As shown on the diagram, the detection zone is polarized. If a target enters the detection zones + and - at the same time, the signals are respectively cancelled and detection could become impossible at maximum detection range. (Please refer to the detection area diagram for details)

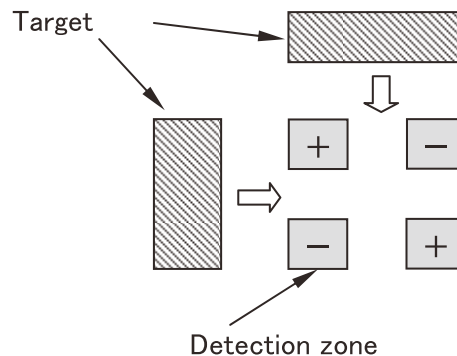

HOW TO USE

1. Wiring Diagram (Digital Output)

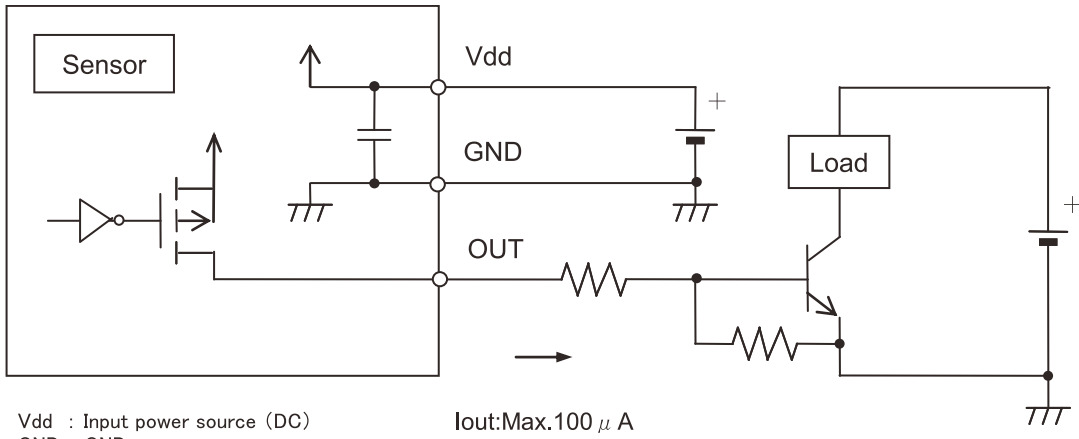

Vdd : Input power source (DC)
 GND : GND
 Out : Output (Comparator)
 Iout:Max.100 μ A

2. Moving Direction

As detailed on the diagram, please install the sensor so that the expected trespassing direction corresponds to the axis X or axis Y.

In some cases, intrusions that occur parallel to the axis Z in every detection zone, closing toward the sensor, may not be detected.

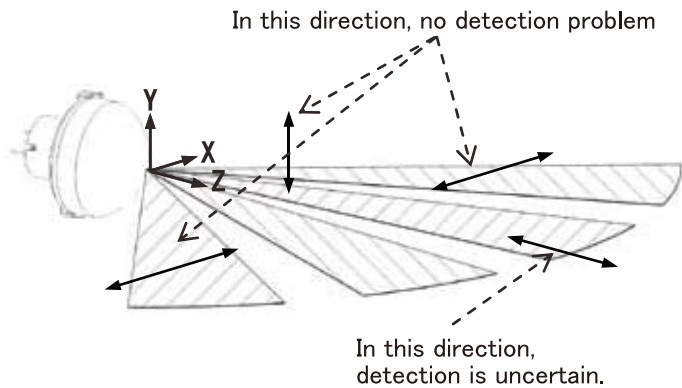
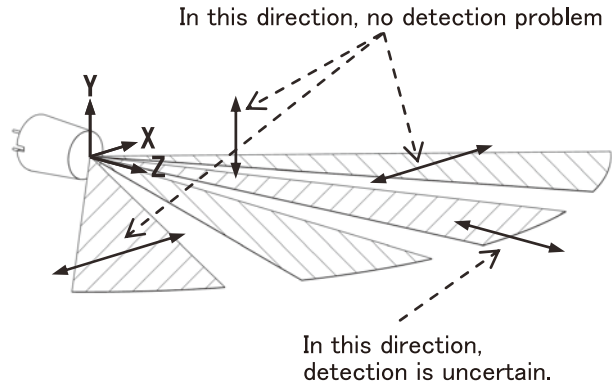

DIMENSION

1) Standard Detection type



White



Black



Pearl White

A-A Cross Sectional

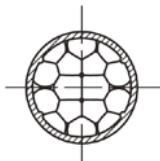

2) Long Distance Detection type



White



Black



Pearl White

A-A Cross Sectional

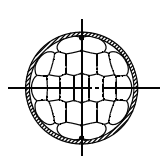

Dimensions

TOP VIEW



SIDE VIEW

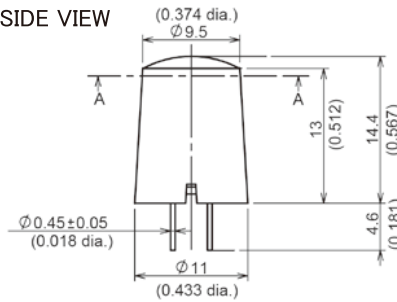

BOTTOM VIEW

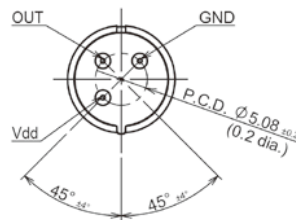

Dimensions

TOP VIEW

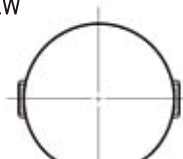

SIDE VIEW

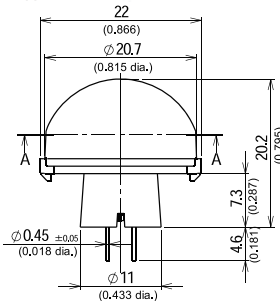

BOTTOM VIEW

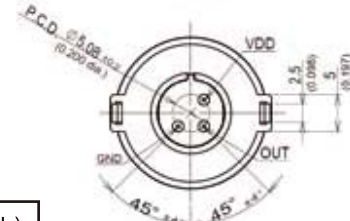

When designing your products

To maintain specified detection capability, position the sensor so that the lens tip is a minimum 1.3mm above the chassis.

The chassis hole requires a taper according to the lens shape, or a larger hole.

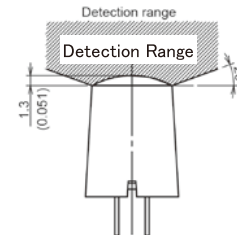

Recommended Hole Drilling Diameter

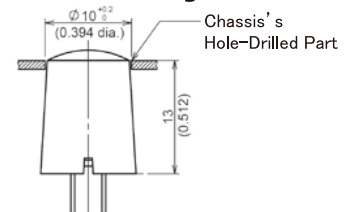

Recommended PCB Pattern Design

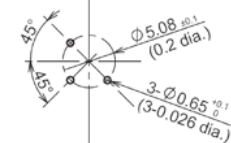

When designing your products

To maintain specified detection capability, please place and expose the sensor so that tip of lens will be more than 7.1mm above the chassis.

The hole of the chassis should have a taper depending on the lens shape, or have a bigger hole.

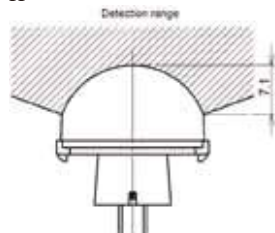

Recommended Hole Drilling Diameter

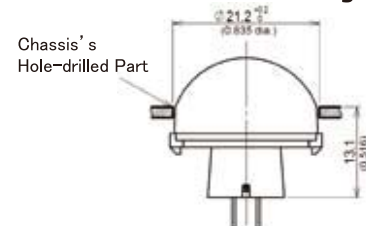

Recommended PCB Pattern Design



General Tolerance ±0.5mm (±0.020inch)