Contents	5
Overview of Types	9

Chip Capacitors	11
-----------------	----

General Technical Information	43
-------------------------------	----

Quality Assurance	61
-------------------	----

Measuring and Test Conditions	75
Soldering Conditions	76

Taping, Packing and Weights	83
-----------------------------	----

Subject Index	86
Symbols and Terms	88

Tantalum Electrolytic Capacitors



Siemens Matsushita Components

Ferrites and inductors in modern office communications

The little things that do so much

In the multimedia age, ferrites and inductors often play a key role. In the switch-mode power supplies of PCs ETD cores ensure interference-free transmission of power. Ring and E cores in energy-saving lamps provide pleasant lighting. Interface transformers in ISDN systems satisfy the high demands of CCITT standards. And ultra-flat planar transformers supply units and installations with the necessary power.



For application-specific products and inductor design you can count on the support of our I.F.C. KNOW-HOW CENTER, right from the initial engineering phase.

SCS – dependable, fast and competent



Contents

Overview of Types	9
Chip Capacitors	11
General technical information	
1 Basic construction	43
2 Polarity	44
3 Standards	44
4 Voltages	45
4.1 Rated voltage	45
4.2 Maximum continuous voltage	45
4.3 Operating voltage	46
4.4 Surge voltage	46
4.5 Polarity reversal voltage (incorrect polarity)	47
4.6 Series back-to-back connection	47
4.7 Inherent voltage	47
4.8 Recharging	47
5 Capacitance	48
5.1 Rated capacitance	48
5.2 Capacitance tolerance	48
5.3 Temperature dependence of the capacitance	48
5.4 Frequency dependence of the capacitance	49
5.5 Charge-discharge proof	49
6 Impedance / Equivalent series resistance (<i>ESR</i>)	50
7 AC power dissipation	52
7.1 Superimposed alternating voltage for capacitors with solid electrolyte	52
7.2 Maximum permissible ripple current and alternating voltage loads	52
8 Dissipation factor	54
9 Leakage current	55
9.1 Temperature and voltage dependence of the leakage current	55
9.2 Time dependence of the leakage current	56
9.3 Leakage current measurement	56
9.4 Leakage current behavior after storage without applied voltage	57
10 Resistance to climatic stress	57
10.1 Temperature range	57
10.2 Minimum permissible operating temperature T_{\min} (Lower category temperature)	57
10.3 Maximum permissible operating temperature T_{\max} (Upper category temperature)	57
10.4 Damp heat conditions	57
10.5 IEC climatic category	58
10.6 Storage and transportation temperatures	58
11 Notes on mounting	58
11.1 Cleaning agents	58

12	Standard barcode label	58
13	Packing	59
14	End of use and disposal	60
15	Structure of the ordering code (part number)	60
Quality Assurance		61
1	General	61
1.1	Total quality management and zero defect concept	62
1.2	Quality assurance system	63
2	Quality assurance procedure	64
2.1	Material procurement	64
2.2	Product quality assurance	64
2.3	Final inspection	64
2.4	Product monitoring	64
2.5	Manufacturing and quality assurance procedures for chip capacitors	65
3	Delivery quality	66
3.1	Random sampling	66
3.2	Classification of inoperatives / non-conformancies	66
3.3	AQL figures	66
3.4	Incoming goods inspection	66
4	Service life	67
4.1	Failure criteria	68
5	Reliability	68
5.1	Failure rate (long-term failure rate)	68
5.2	Failure rate values	69
5.3	Failure rate conversion factors	70
5.4	Effect of the circuit resistance (series resistance) on the failure rate	71
5.5	Example of how to calculate the failure rate	72
5.6	Failure rate for B 45 194	72
6	Supplementary information	73
7	Handling of claims and complaints	74
Measuring and Test Conditions		75
1	Test conditions selected from IEC 60-384-1	75
2	Tests with more stringent conditions for B 45 196-P	75
Soldering Conditions		76
1	Tests	76
2	Recommended solder pad layouts	77
3	Recommended soldering temperature profiles	78
4	Recommended soldering temperature profiles for B 45 194	80

Contents

Taping, Packing and Weights	83
1 Taping	83
2 Packing	84
3 Packing units and weights	84
Subject Index	86
Symbols and Terms	88



Siemens Matsushita Components

Siemens filters from stock

Ready,
steady, go

SCS has 100,000 SIFI filters in stock, ready to go as soon as your order arrives. We offer a big selection through all the many variants, ie



building-block system, different attenuation characteristics and packages, various kinds of leads and current ratings from 1 through 20 A.

SCS – dependable, fast and competent



Overview of Types

Type	Series	Rated voltage V_R Vdc	Rated capacitance C_R μF	Features	Page
Chip capacitors					11
 KTA0145-4	B 45 194	4 ... 20	0,10 ... 3,3	Ultra-small design Case size Z $\hat{=}$ 0805 Case size P $\hat{=}$ 1206	16
	B 45 196-E B 45 198-E	4 ... 50	0,10 ... 100	Standard version IECQ/CECC-approved	24
	B 45 196-H B 45 198-H	4 ... 50	0,15 ... 470	"HighCap" Very high volumetric efficiency	27
	B 45 196-P B 45 198-P	4 ... 50	0,10 ... 150	"Performance" Extremely high reliability, IECQ/CECC-approved (150 °C version)	31
	B 45 197 B 45 198-R	6,3 ... 50	3,3 ... 330	"SpeedPower" Low <i>ESR</i> , for power supplies with very high clock frequencies	35



Siemens Matsushita Components

European technology center for
ceramic components

There when you need us

This is an organization that's proven its worth. Because it stands for more customer proximity and thus better service. Here you get information straight from the source, implementation of the latest technologies and products that match the market. Concentration of resources means that design engineers and production engineers are working side by side. And SCS warehousing directly at the plant ensures fastest possible delivery.



SCS – dependable, fast and competent

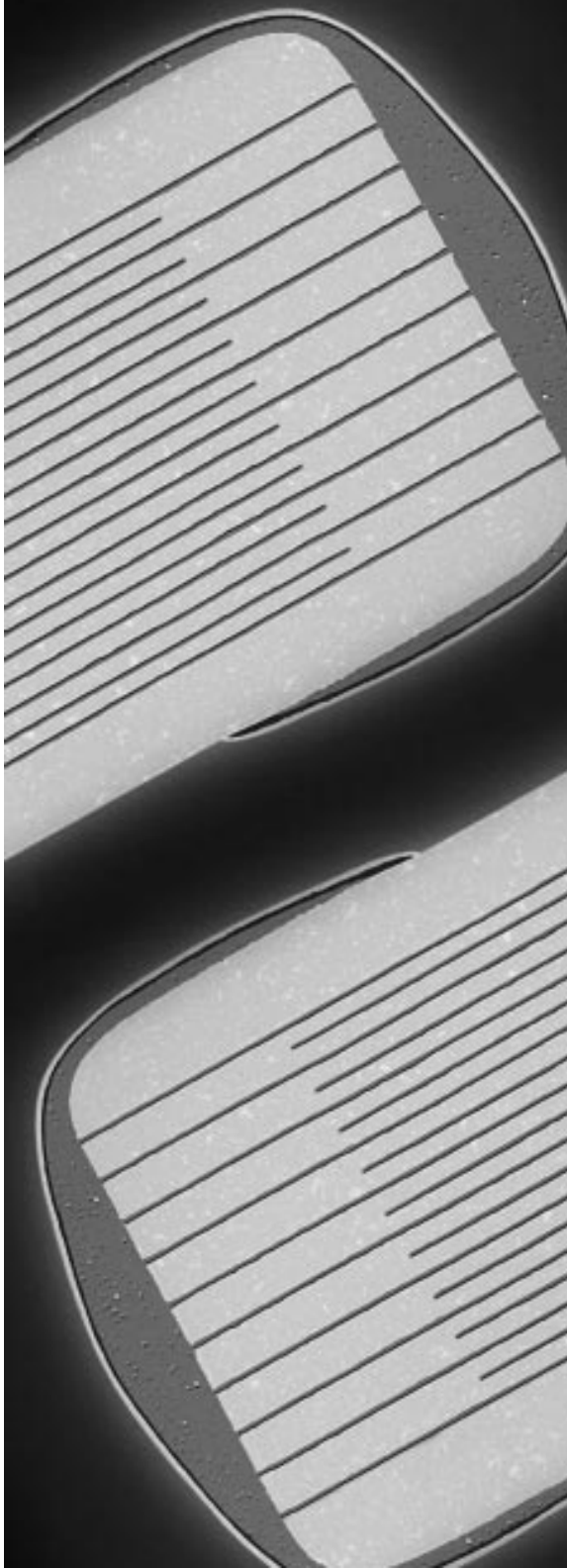

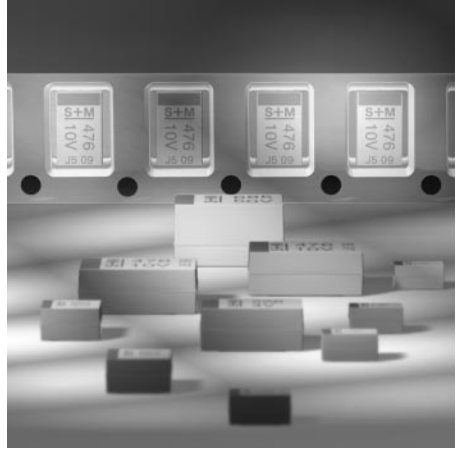

	Page
B 45 194	
General specifications	12
Overview of available types	15
Technical data and ordering codes	16
Characteristic curves	17
B 45 196, B 45 197, B 45 198	
General specifications	18
Overview of available types	22
Technical data and ordering codes	24
Characteristic curves	37

Construction

- Polar tantalum capacitors with solid electrolyte
- Flame-retardant plastic case (UL 94 V-0)
- Tinned terminals



Features

- Ultra-small design
Case size Z $\hat{=}$ 0805 and P $\hat{=}$ 1206 (low profile)
- High volumetric efficiency
- Excellent solderability
- Stable temperature and frequency characteristics
- Low leakage current, low dissipation factor
- Low self-inductance
- High resistance to shock and vibration
- Suitable for use without series resistor

Applications

- Telecommunications (e.g. pagers, handies)
- Data processing (e.g. PCMA cards)
- Medical engineering (e.g. hearing aids)

Soldering

Suitable for reflow soldering (IR and vapor phase) and wave soldering

Delivery mode

Taped and reeled in accordance with IEC 286-3

Ordering code structure

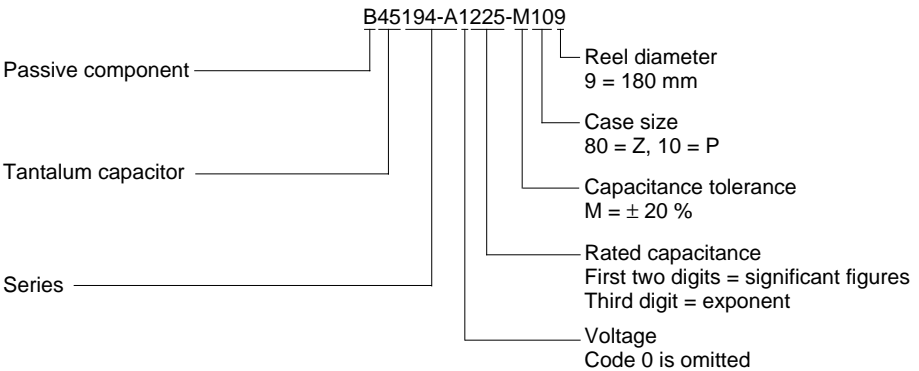



Specifications and characteristics in brief

Series	B 45 194
Overview of available types	Page 15
Rated voltage V_R (up to 85 °C)	4 ... 20 Vdc
Rated capacitance C_R	0,10 ... 3,3 μ F
Tolerance	$\pm 20 \%$
Failure rate	Refer to page 72
Leakage current (V_R , 2 min, 20 °C)	$\leq 0,5 \mu$ A
IEC climatic category	in accordance with IEC 68-1 55/125/21 (-55/+125 °C; 21 days damp heat test)

! Any general information given in the second part of this data book (starting with [page 43](#)) only applies to B 45 194 if the B 45 194 series or its cases Z and P are explicitly mentioned. Please contact your nearest Siemens Office for Passive Components if you need further information.

Dimensional drawing

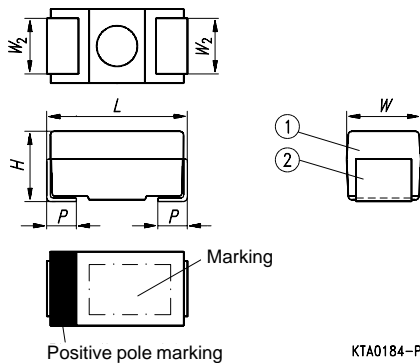

Case size	Dimensions in mm (inches)				
	$L \pm 0,2$ $\pm (.008)$	$W \pm 0,2$ $\pm (.008)$	H max.	$W_2 \pm 0,1$ $\pm (.004)$	p
Z	2,0 (,079)	1,25 (,049)	1,2 (,047)	0,9 (,035)	$0,5 \pm 0,2$ (,020 \pm ,008)
P	3,2 (,126)	1,6 (,062)	1,2 (,047)	1,2 (,047)	$0,8 \pm 0,3$ (,031 \pm ,012)



Marking

Case size Z

Positive pole (bar)

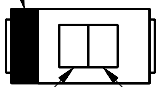

Rated voltage (in coded form) Capacitance (in coded form)

KTA0205-G

Case size P

Positive pole (bar)

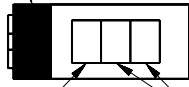

Rated voltage (in coded form) Capacitance (in coded form)

KTA0206-P

Voltage coding

Rated voltage	4	6,3	10	16	20
Code letter	G	J	A	C	D

Capacitance coding

1st digit (capacitance)

Code letter	A	E	J	N	S	W
Cap. value	1	1,5	2,2	3,3	4,7 ¹⁾	6,8 ¹⁾

2nd digit (multiplier)

Code number	5	6
Multiplier	10 ⁵	10 ⁶

Example: 6,3 V; 1,5 µF in P case: JE6

Voltage: 6,3 V = J

Capacitance: 1,5 µF = 1,5 · 10⁶ pF
1,5 = E
10⁶ = 6

For case size Z the code number for the multiplier is omitted. Example : JE

1) Cap. value 0,47 and 0,68 µF for case size Z



Overview of available types

V_R (Vdc) up to 85 °C	4,0	6,3	10	16	20
C_R (μF)					
0,10					P
0,15					P
0,22					P
0,33					P
0,47				Z	P
0,68				Z P	P
1,0			Z P	P	
1,5		Z P	P		
2,2	Z P	P			
3,3	P				
Features	Ultra-small design Low profile				



B 45 194

Technical data and ordering codes

For characteristic curves see [page 17](#)

V_R ¹⁾ up to 85°C (up to 125°C) Vdc	C_R μF	Case size	$\tan \delta_{\max}$ (20°C, 120 Hz)	$I_{k, \max}$ (20°C, V_R , 2 min) μA	Ordering code
4,0 (2,5)	2,2	Z	0,10	0,5	B45194-A225-M809
	2,2	P	0,04	0,5	B45194-A225-M109
	3,3	P	0,04	0,5	B45195-A335-M109
6,3 (4)	1,5	Z	0,10	0,5	B45194-A1155-M809
	1,5	P	0,04	0,5	B45194-A1155-M109
	2,2	P	0,04	0,5	B45194-A1225-M109
10 (6,3)	1,0	Z	0,10	0,5	B45194-A2105-M809
	1,0	P	0,04	0,5	B45194-A2105-M109
	1,5	P	0,04	0,5	B45194-A2155-M109
16 (10)	0,47	Z	0,10	0,5	B45194-A3474-M809
	0,68	Z	0,10	0,5	B45194-A3684-M809
	0,68	P	0,04	0,5	B45194-A3684-M109
	1,0	P	0,04	0,5	B45194-A3105-M109
20 (13)	0,10	P	0,04	0,5	B45194-A4104-M109
	0,15	P	0,04	0,5	B45194-A4154-M109
	0,22	P	0,04	0,5	B45194-A4224-M109
	0,33	P	0,04	0,5	B45194-A4334-M109
	0,47	P	0,04	0,5	B45194-A4474-M109
	0,68	P	0,04	0,5	B45194-A4684-M109

Capacitance tolerance: M = ± 20 %

1) Surge voltage $V_S = 1,3 \cdot V_R$



Impedance Z and equivalent series resistance ESR versus frequency f
 Typical behavior

Case size Z

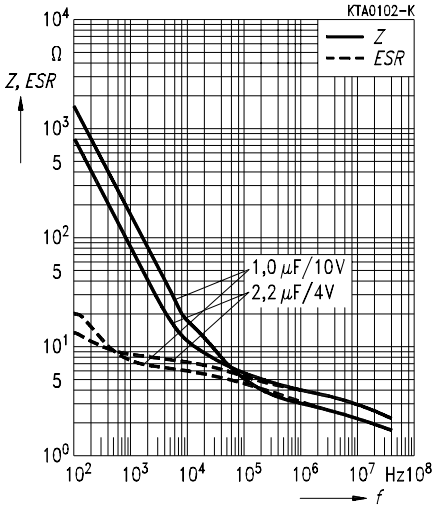

Impedance Z and equivalent series resistance ESR versus frequency f
 Typical behavior

Case size P

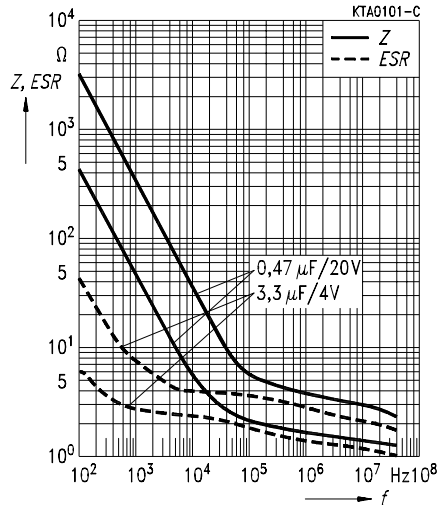



Construction

- Polar tantalum capacitors with solid electrolyte
- Flame-retardant plastic case (UL 94 V-0)
- Optionally tinned or gold-plated terminals
(gold-plated terminals for case size A upon request)

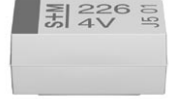

Features

- High volumetric efficiency
- Excellent solderability
- Stable temperature and frequency characteristics
- Low leakage current, low dissipation factor
- Low self-inductance
- High resistance to shock and vibration
- Suitable for use without series resistor

Applications

- Telecommunications (e.g. mobile phones, private branch exchanges)
- Data processing (e.g. laptops, main frames)
- Measuring and control engineering
- Automotive electronics
- Medical engineering
- Switch-mode power supplies with very high clock frequencies (300 kHz)
- DC/DC converters

Soldering

Suitable for reflow soldering (IR and vapor phase) and wave soldering

Delivery mode

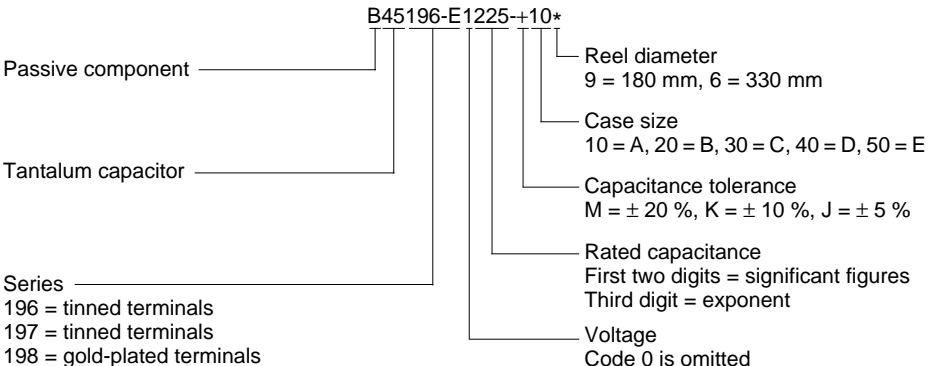

Taped and reeled in accordance with IEC 286-3

Ordering code structure





Specifications and characteristics in brief

Series	B 45 196-E 	B 45 196-H HighCap	B 45 196-P 	B 45 197 SpeedPower (Low ESR)
Overview of available types	Page 22		Page 23	
Rated voltage V_R (up to 85 °C)	4 ... 50 Vdc	4 ... 50 Vdc	4 ... 50 Vdc	6,3 ... 50 Vdc
Rated capacitance C_R	0,10 ... 100 μF	0,15 ... 470 μF	0,10 ... 150 μF	3,3 ... 330 μF
Tolerance	$\pm 10 \%$, $\pm 20 \%$ $\pm 5\%$ (on request)	$\pm 10 \%$, $\pm 20 \%$ $\pm 5\%$ (on request)	$\pm 10 \%$, $\pm 20 \%$ $\pm 5\%$ (on request)	$\pm 10 \%$, $\pm 20 \%$ $\pm 5\%$ (on request)
Failure rate	at 40 °C; $\leq V_R$, $R_S \geq 3\Omega/\text{V}$ (1 fit = $1 \cdot 10^{-9}$ failures/h)			
$C_R \cdot V_R \leq 330 \mu\text{F} \cdot \text{V}$	≤ 3 fit	≤ 8 fit	$\leq 0,8$ fit	≤ 8 fit
$C_R \cdot V_R > 330 \mu\text{F} \cdot \text{V}$	≤ 10 fit	≤ 24 fit	$\leq 2,5$ fit	≤ 12 fit
Service life	> 500 000 h	> 500 000 h	> 500 000 h	> 500 000 h
Leakage current (V_R , 5 min, 20 °C)	10 nA/ μC	10 nA/ μC	10 nA/ μC	10 nA/ μC
ESR	—	—	—	100 ... 600 m Ω
Detail specification (tinned terminals)	IEC-QC300801/ US0001 CECC30801-801	CECC30801-802	IEC-QC300801/ US0001 CECC30801-801	CECC30801-805
Quality approval	IECQ CECC		IECQ CECC	
IEC climatic category	in accordance with IEC 68-1 55/125/56 (–55/+125 °C; 56 days damp heat test)			

For types B 45 196-P, individual tests are carried out under more extreme conditions, supplementary to the tests specified by CECC.

Examples:

Damp heat	85 (+2) °C, 85 ... 90% relative humidity
Rapid temperature change	100 cycles, – 55°C/+ 125 °C, 30 min.
Surge voltage	10 ⁴ charge cycles
Impulse test	10 ⁶ cycles

Types B 45 196-P can be operated at temperatures up to 150 °C.

Details for this operating condition must be agreed upon between supplier and customer.



**B 45 196, B 45 197
B 45 198**

Dimensional drawing

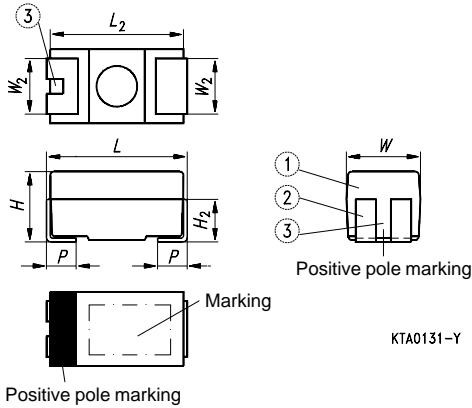

- ① Encapsulation: molded epoxy resin
- ② NiFe; surface Sn60/Pb40 or Sn90/Pb10 or gold-plated
- ③ Reduced slot length for case size A

Case size	Dimensions in mm (inches)						
	L	W	H	L_2 typ.	$W_2 \pm 0,1$ $\pm(,004)$	H_2 typ.	$p \pm 0,3$ $\pm(,012)$
A	$3,2 \pm 0,2$ (,126±,008)	$1,6 \pm 0,2$ (,063±,008)	$1,6 \pm 0,2$ (,063±,008)	3,0 (,118)	1,2 (,047)	1,0 (,039)	0,8 (,031)
B	$3,5 \pm 0,2$ (,138±,008)	$2,8 \pm 0,2$ (,110±,008)	$1,9 \pm 0,2$ (,075±,008)	3,3 (,130)	2,2 (,087)	1,2 (,047)	0,8 (,031)
C	$6,0 \pm 0,3$ (,236±,012)	$3,2 \pm 0,3$ (,126±,012)	$2,5 \pm 0,3$ (,098±,012)	5,8 (,228)	2,2 (,087)	1,5 (,059)	1,3 (,051)
D	$7,3 \pm 0,3$ (,287±,012)	$4,3 \pm 0,3$ (,169±,012)	$2,8 \pm 0,3$ (,110±,012)	7,1 (,280)	2,4 (,094)	1,6 (,062)	1,3 (,051)
E	$7,3 \pm 0,3$ (,287±,012)	$4,3 \pm 0,3$ (,169±,012)	$4,1 \pm 0,3$ (,157±,012)	7,1 (,280)	2,4 (,094)	1,6 (,062)	1,3 (,051)



Marking

Case size A

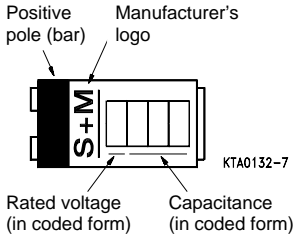

Case size B

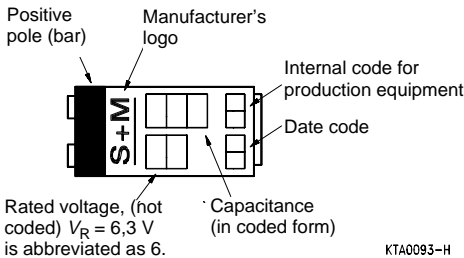
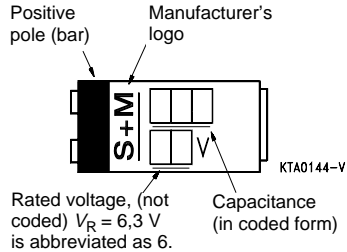

Case sizes C, D, E

Voltage coding for case size A

Rated voltage	4	6,3	10	16	20	25	35	50
Code letter	G	J	A	C	D	E	V	T

Capacitance coding

1st and 2nd digit	Capacitance in pF
3rd digit	Multiplier: 4 = 10 ⁴ pF 5 = 10 ⁵ pF 6 = 10 ⁶ pF 7 = 10 ⁷ pF

Date coding

Year	Month	
H = 1996	1 = January	7 = July
J = 1997	2 = February	8 = August
K = 1998	3 = March	9 = September
L = 1999	4 = April	O = October
M = 2000	5 = May	N = November
	6 = June	D = December

In addition to the year and month of manufacture, the stamp includes another two figures which internally allow us an assignment to concrete production equipment. Stamping of chips in case sizes A and B with date code is currently not possible for reasons of space.



B 45 196, B 45 197
B 45 198

Overview of available types

Series	B 45 196-E, tinned terminals B 45 198-E, gold-plated terminals ¹⁾ Standard								B 45 196-H, tinned terminals B 45 198-H, gold-plated terminals ¹⁾ HighCap ²⁾									
Page	24								27									
V_R (Vdc) up to 85 °C	4	6,3	10	16	20	25	35	50	4	6,3	10	16	20	25	35	50		
C_R (µF)																		
0,10							A	A										
0,15							A	B								A		
0,22							A	B								A		
0,33							A	B										
0,47						A	B	C							A	B		
0,68					A	A	B	C							A			
1,0				A	A		B	C						A	A			
1,5			A	A		B	C	D					A	A	B	C		
2,2		A	A		B	B	C	D				A	A		B			
3,3	A	A		B	B	C	C	D			A	A	A	B				
4,7	A		B	B	C	C	D	D		A	A	A	B	A	B	C		
6,8		B	B	C	C	D	D		A	A	A	B	A	B	C	C	E	
10	B	B	C	C		D	D		A	A	A	B	B	C	B	C	E	
15	B	C	C		D	D			A	A	B	B	C	B	C		D	
22	C	C		D	D				B	A	B	B	C	C	C	D	E	
33	C		D	D					B	B	C	C	C	C	D	E	D	E
47		D	D						B	C	B	C	C	D	D	E	E	
68	D	D							C	C	D	C	D	E				
100	D								C	C	D	D	D	E	E			
150									D	D	D	E	E					
220									D	D	E	E	D					
330									E	E	D	E						
470									E	E								
Features	Standard version with IECQ and CECC approval.								Particularly high volumetric efficiency.									

Upon request

1) Gold-plated terminals available for case sizes B, C, D, E (A upon request), currently without CECC approval
 2) Additional ratings upon request



Overview of available types

Series	B 45 196-P, tinned terminals B 45 198-P, gold-plated terminals ¹⁾ Performance  ²⁾							B 45 197-A, tinned terminals B 45 198-R, gold-plated terminals ¹⁾ SpeedPower (Low ESR)²⁾							
Page	31							35							
V _R (Vdc) up to 85 °C	4	6,3	10	16	20	25	35	50	6,3	10	16	20	25	35	50
C _R (µF)															
0,10							A	A							
0,15							A	B							
0,22							A	B							
0,33							A	B							
0,47						A	B	C							
0,68					A	A	B	C							
1,0				A	A	A	B	C							
1,5			A	A	A	B	C	D							
2,2		A	A	A	B	B	C	D							
3,3	A	A	A	B	B	C	C	D							C
4,7	A	A	B	B	C	C	D	D					C	D	D
6,8	A	B	B	C	C	C	D				C		D	E	E
10	B	B	B	C	C	C	D	D			C	C		D	E
15	B	C	C	C	D	D				C	C		D	D	E
22	C	C	C	C	D	D			C	C		D	D	E	E
33	C	C	D	D	D				C		D	D	E	E	
47	C	C	D	D						D	D	E			
68	D	D	D							D	D	E	E		
100	D	D	D							D	D	E	E		
150	D									E	E				
220										E	E				
330										E	E				
Features	Outstanding reliability, e. g. for automotive electronics and medical applications, IECQ and CECC approval.							Low <i>ESR</i> , for switch-mode power supplies with very high clock frequencies (e. g. telecom applications).							

1) Gold-plated terminals available for case sizes B, C, D, E (A upon request), currently without CECC approval
2) Additional ratings upon request

**Technical data and ordering codes**For characteristic curves [see page 37/38 ff](#)

V_R up to 85 °C (up to 125 °C) Vdc	C_R μF	Case size	$\tan \delta_{\text{max}}$ (20 °C, 120 Hz)	$I_{k, \text{max}}$ (20 °C, V_R , 5 min) μA	Z_{max} (20 °C, 100 kHz) Ω	Ordering code 1) Tinned terminals
4 (2,5)	3,3	A	0,06	0,5	9,0	B45196-E335-+10*
	4,7	A	0,06	0,5	7,0	B45196-E475-+10*
	10	B	0,06	0,5	4,5	B45196-E106-+20*
	15	B	0,06	0,6	3,5	B45196-E156-+20*
	22	C	0,06	0,9	2,4	B45196-E226-+30*
	33	C	0,06	1,3	2,0	B45196-E336-+30*
6,3 (4)	68	D	0,06	2,7	1,1	B45196-E686-+40*
	100	D	0,08	4,0	0,8	B45196-E107-+40*
	2,2	A	0,06	0,5	10	B45196-E1225-+10*
	3,3	A	0,06	0,5	7,0	B45196-E1335-+10*
	6,8	B	0,06	0,5	4,5	B45196-E1685-+20*
	10	B	0,06	0,6	3,5	B45196-E1106-+20*
10 (6,3)	15	C	0,06	1,0	2,4	B45196-E1156-+30*
	22	C	0,06	1,4	2,0	B45196-E1226-+30*
	47	D	0,06	3,0	1,1	B45196-E1476-+40*
	68	D	0,06	4,3	0,8	B45196-E1686-+40*
	1,5	A	0,06	0,5	10	B45196-E2155-+10*
	2,2	A	0,06	0,5	7,0	B45196-E2225-+10*
16 (10)	4,7	B	0,06	0,5	4,5	B45196-E2475-+20*
	6,8	B	0,06	0,7	3,5	B45196-E2685-+20*
	10	C	0,06	1,0	2,4	B45196-E2106-+30*
	15	C	0,06	1,5	2,0	B45196-E2156-+30*
	33	D	0,06	3,3	1,1	B45196-E2336-+40*
	47	D	0,06	4,7	0,8	B45196-E2476-+40*
1,0	1,5	A	0,04	0,5	10	B45196-E3105-+10*
	3,3	B	0,06	0,6	5,0	B45196-E3335-+20*
	4,7	B	0,06	0,8	3,5	B45196-E3475-+20*
	6,8	C	0,06	1,1	2,4	B45196-E3685-+30*
	10	C	0,06	1,6	2,0	B45196-E3106-+30*
	22	D	0,06	3,6	1,1	B45196-E3226-+40*
33	D	0,06	5,3	1,0	B45196-E3336-+40*	

1) Replace 196 by 198 for gold-plated terminals

+ Insert code letter for required capacitance tolerance: M = $\pm 20\%$, K = $\pm 10\%$ (J = $\pm 5\%$ upon request)

* Insert code number for required reel diameter: 9 = 180 mm, 6 = 330 mm



V_R up to 85 °C (up to 125 °C) Vdc	C_R μF	Case size	$\tan \delta_{max}$ (20 °C, 120 Hz)	$I_{lk, max}$ (20 °C, V_R , 5 min) μA	Z_{max} (20 °C, 100 kHz) Ω	Ordering code 1) Tinned terminals
20 (13)	0,68	A	0,04	0,5	12	B45196-E4684-+10*
	1,0	A	0,04	0,5	9,0	B45196-E4105-+10*
	2,2	B	0,06	0,5	6,0	B45196-E4225-+20*
	3,3	B	0,06	0,7	4,5	B45196-E4335-+20*
	4,7	C	0,06	1,0	2,4	B45196-E4475-+30*
	6,8	C	0,06	1,4	2,0	B45196-E4685-+30*
	15	D	0,06	3,0	1,2	B45196-E4156-+40*
25 (16)	0,47	A	0,04	0,5	13	B45196-E5474-+10*
	0,68	A	0,04	0,5	10	B45196-E5684-+10*
	1,5	B	0,06	0,5	7,0	B45196-E5155-+20*
	2,2	B	0,06	0,6	5,0	B45196-E5225-+20*
	3,3	C	0,06	0,9	2,8	B45196-E5335-+30*
	4,7	C	0,06	1,2	2,3	B45196-E5475-+30*
	6,8	D	0,06	1,7	1,8	B45196-E5685-+40*
35 (23)	10	D	0,06	2,5	1,2	B45196-E5106-+40*
	15	D	0,06	3,8	1,0	B45196-E5156-+40*
	0,10	A	0,04	0,5	28	B45196-E6104-+10*
	0,15	A	0,04	0,5	23	B45196-E6154-+10*
	0,22	A	0,04	0,5	19	B45196-E6224-+10*
	0,33	A	0,04	0,5	15	B45196-E6334-+10*
	0,47	B	0,04	0,5	11	B45196-E6474-+20*
	0,68	B	0,04	0,5	8,0	B45196-E6684-+20*
	1,0	B	0,04	0,5	7,0	B45196-E6105-+20*
	1,5	C	0,06	0,6	4,8	B45196-E6155-+30*
	2,2	C	0,06	0,8	3,2	B45196-E6225-+30*
	3,3	C	0,06	1,2	2,4	B45196-E6335-+30*
	4,7	D	0,06	1,7	1,5	B45196-E6475-+40*
6,8	D	0,06	2,4	1,2	B45196-E6685-+40*	
10	D	0,06	3,5	1,0	B45196-E6106-+40*	

1) Replace 196 by 198 for gold-plated terminals

+ Insert code letter for required capacitance tolerance: M = $\pm 20\%$, K = $\pm 10\%$ (J = $\pm 5\%$ upon request)

* Insert code number for required reel diameter: 9 = 180 mm, 6 = 330 mm

**B 45 196-E**

V_R up to 85°C (up to 125°C) Vdc	C_R μF	Case size	$\tan \delta_{max}$ (20°C, 120 Hz)	$I_{lk, max}$ (20°C, V_R , 5 min) μA	Z_{max} (20°C, 100 kHz) Ω	Ordering code 1) Tinned terminals
50 (33)	0,10	A	0,04	0,5	27	B45196-E7104-+10*
	0,15	B	0,04	0,5	22	B45196-E7154-+20*
	0,22	B	0,04	0,5	18	B45196-E7224-+20*
	0,33	B	0,04	0,5	14	B45196-E7334-+20*
	0,47	C	0,04	0,5	7,2	B45196-E7474-+30*
	0,68	C	0,04	0,5	6,4	B45196-E7684-+30*
	1,0	C	0,04	0,5	4,8	B45196-E7105-+30*
	1,5	D	0,06	0,8	4,0	B45196-E7155-+40*
	2,2	D	0,06	1,1	2,8	B45196-E7225-+40*
	3,3	D	0,06	1,7	1,6	B45196-E7335-+40*
4,7	D	0,06	2,4	1,2	B45196-E7475-+40*	

1) Replace 196 by 198 for gold-plated terminals

+ Insert code letter for required capacitance tolerance: M = $\pm 20\%$, K = $\pm 10\%$ (J = $\pm 5\%$ upon request)

* Insert code number for required reel diameter: 9 = 180 mm, 6 = 330 mm



Technical data and ordering codes

For characteristic curves [see page 37/38 ff](#)

V_R up to 85°C (up to 125°C) Vdc	C_R μF	Case size	$\tan \delta_{\max}$ (20°C, 120 Hz)	$I_{k, \max}$ (20°C, V_R , 5 min) μA	Z_{\max} (20°C, 100 kHz) Ω	Ordering code 1) Tinned terminals
4 (2,5)	6,8	A	0,06	0,5	6,0	B45196-H685-+10*
	10	A	0,06	0,5	4,5	B45196-H106-+10*
	15	A	0,06	0,6	4,0	B45196-H156-+10*
	22 ²⁾	A	0,06	0,9	3,5	B45196-H226-+10*
	22	B	0,06	0,9	3,0	B45196-H226-+20*
	33	B	0,06	1,3	2,5	B45196-H336-+20*
	47	B	0,06	1,9	2,3	B45196-H476-+20*
	47	C	0,06	1,9	1,6	B45196-H476-+30*
	68	C	0,06	2,7	1,5	B45196-H686-+30*
	100	C	0,08	4,0	1,4	B45196-H107-+30*
	150	D	0,08	6,0	0,8	B45196-H157-+40*
	220	D	0,08	8,8	0,8	B45196-H227-+40*
	330	E	0,08	13,2	0,8	B45196-H337-+50*
470	E	0,08	18,8	0,6	B45196-H477-+50*	
6,3 (4)	4,7	A	0,06	0,5	5,5	B45196-H1475-+10*
	6,8	A	0,06	0,5	4,5	B45196-H1685-+10*
	10	A	0,06	0,6	4,0	B45196-H1106-+10*
	15	A	0,06	0,9	3,8	B45196-H1156-+10*
	15	B	0,06	0,9	3,0	B45196-H1156-+20*
	22	B	0,06	1,4	2,5	B45196-H1226-+20*
	33	B	0,06	2,1	2,2	B45196-H1336-+20*
	33	C	0,06	2,1	1,6	B45196-H1336-+30*
	47	B	0,06	3,0	2,0	B45196-H1476-+20*
	47	C	0,06	3,0	1,5	B45196-H1476-+30*
	68	C	0,06	4,3	1,4	B45196-H1686-+30*
	100	C	0,08	6,3	1,2	B45196-H1107-+30*
	100	D	0,08	6,3	0,8	B45196-H1107-+40*
	150	D	0,08	9,5	0,8	B45196-H1157-+40*
	220	D	0,08	13,9	0,8	B45196-H1227-+40*
	220	E	0,08	13,9	0,8	B45196-H1227-+50*
	330	D	0,08	20,8	0,8	B45196-H1337-+40*
	330	E	0,08	20,8	0,6	B45196-H1337-+50*
	470	E	0,08	29,6	0,6	B45196-H1477-+50*

1) Replace 196 by 198 for gold-plated terminals

+ Insert code letter for required capacitance tolerance: M = $\pm 20\%$, K = $\pm 10\%$ (J = $\pm 5\%$ upon request)

* Insert code number for required reel diameter: 9 = 180 mm, 6 = 330 mm

2) Upon request



B 45 196-H

V_R up to 85°C (up to 125°C) Vdc	C_R μF	Case size	$\tan \delta_{\max}$ (20°C, 120 Hz)	$I_{k, \max}$ (20°C, V_R , 5 min) μA	Z_{\max} (20°C, 100 kHz) Ω	Ordering code 1) Tinned terminals
10 (6,3)	3,3	A	0,06	0,5	5,5	B45196-H2335-+10*
	4,7	A	0,06	0,5	4,5	B45196-H2475-+10*
	6,8	A	0,06	0,7	4,0	B45196-H2685-+10*
	10	A	0,06	1,0	3,8	B45196-H2106-+10*
	10	B	0,06	1,0	3,0	B45196-H2106-+20*
	15	B	0,06	1,5	2,5	B45196-H2156-+20*
	22	B	0,06	2,2	2,3	B45196-H2226-+20*
	22	C	0,06	2,2	1,6	B45196-H2226-+30*
	33	C	0,06	3,0	1,5	B45196-H2336-+30*
	47	C	0,06	4,7	1,4	B45196-H2476-+30*
	68 ²⁾	C	0,06	6,8	1,2	B45196-H2686-+30*
	68	D	0,06	6,8	0,8	B45196-H2686-+40*
	100	D	0,08	10	0,8	B45196-H2107-+40*
	150	D	0,08	15	0,8	B45196-H2157-+40*
	150	E	0,08	15	0,8	B45196-H2157-+50*
	220 ²⁾	D	0,08	22	0,8	B45196-H2227-+40*
	220	E	0,08	22	0,6	B45196-H2227-+50*
330	E	0,08	33	0,6	B45196-H2337-+50*	
16 (10)	2,2	A	0,06	0,5	6,5	B45196-H3225-+10*
	3,3	A	0,06	0,5	5,0	B45196-H3335-+10*
	4,7	A	0,06	0,8	4,0	B45196-H3475-+10*
	6,8 ²⁾	A	0,06	1,1	3,8	B45196-H3685-+10*
	6,8	B	0,06	1,1	3,0	B45196-H3685-+20*
	10	B	0,06	1,6	2,5	B45196-H3106-+20*
	15 ²⁾	B	0,06	2,4	2,3	B45196-H3156-+20*
	15	C	0,06	2,4	1,6	B45196-H3156-+30*
	22	C	0,06	3,5	1,5	B45196-H3226-+30*
	33	C	0,06	5,3	1,4	B45196-H3336-+30*
	47	D	0,06	7,5	0,8	B45196-H3476-+40*
	68	D	0,06	10,9	0,8	B45196-H3686-+40*
	100 ²⁾	D	0,08	16	0,8	B45196-H3107-+40*
	100	E	0,08	16	0,8	B45196-H3107-+50*
	150 ²⁾	E	0,08	24	0,6	B45196-H3157-+50*

1) Replace 196 by 198 for gold-plated terminals

+ Insert code letter for required capacitance tolerance: M = ± 20 %, K = ± 10 % (J = ± 5 % upon request)

* Insert code number for required reel diameter: 9 = 180 mm, 6 = 330 mm

2) Upon request



V_R up to 85 °C (up to 125 °C) Vdc	C_R μF	Case size	$\tan \delta_{max}$ (20 °C, 120 Hz)	$I_{k, max}$ (20 °C, V_R , 5 min) μA	Z_{max} (20 °C, 100 kHz) Ω	Ordering code 1) Tinned terminals
20 (13)	1,5	A	0,06	0,5	8,0	B45196-H4155-+10*
	2,2	A	0,06	0,5	6,0	B45196-H4225-+10*
	3,3 ²⁾	A	0,06	0,7	4,0	B45196-H4335-+10*
	4,7 ²⁾	A	0,06	0,9	3,5	B45196-H4475-+10*
	4,7	B	0,06	0,9	3,0	B45196-H4475-+20*
	6,8	B	0,06	1,4	2,5	B45196-H4685-+20*
	10 ²⁾	B	0,06	2,0	2,3	B45196-H4106-+20*
	10	C	0,06	2,0	1,6	B45196-H4106-+30*
	15	C	0,06	3,0	1,5	B45196-H4156-+30*
	22	C	0,06	4,4	1,4	B45196-H4226-+30*
	33	D	0,06	6,6	0,8	B45196-H4336-+40*
	47	D	0,06	9,4	0,8	B45196-H4476-+40*
	47	E	0,06	9,4	0,8	B45196-H4476-+50*
	68	E	0,06	13,6	0,8	B45196-H4686-+50*
	100 ²⁾	E	0,08	20,0	0,8	B45196-H4107-+50*
25 (16)	1,0	A	0,04	0,5	8,0	B45196-H5105-+10*
	1,5	A	0,06	0,5	7,0	B45196-H5155-+10*
	3,3	B	0,06	0,8	4,0	B45196-H5335-+20*
	4,7	B	0,06	1,2	3,2	B45196-H5475-+20*
	6,8	C	0,06	1,7	2,0	B45196-H5685-+30*
	10	C	0,06	2,5	1,6	B45196-H5106-+30*
	22	D	0,06	5,5	0,8	B45196-H5226-+40*
	33 ²⁾	D	0,06	8,3	0,8	B45196-H5336-+40*
	33	E	0,06	8,3	0,8	B45196-H5336-+50*
	47 ²⁾	E	0,06	11,7	0,8	B45196-H5476-+50*

1) Replace 196 by 198 for gold-plated terminals
 + Insert code letter for required capacitance tolerance: M = ± 20 %, K = ± 10 % (J = ± 5 % upon request)
 * Insert code number for required reel diameter: 9 = 180 mm, 6 = 330 mm
 2) Upon request



B 45 196-H

V_R up to 85°C (up to 125°C) Vdc	C_R μF	Case size	$\tan \delta_{\max}$ (20°C, 120 Hz)	$I_{k, \max}$ (20°C, V_R , 5 min) μA	Z_{\max} (20°C, 100 kHz) Ω	Ordering code 1) Tinned terminals
35 (23)	0,47	A	0,04	0,5	11	B45196-H6474-+10*
	0,68	A	0,04	0,5	8,0	B45196-H6684-+10*
	1,0	A	0,04	0,5	7,0	B45196-H6105-+10*
	1,5	B	0,06	0,5	6,0	B45196-H6155-+20*
	2,2	B	0,06	0,8	4,0	B45196-H6225-+20*
	4,7	C	0,06	1,6	2,0	B45196-H6475-+30*
	6,8	C	0,06	2,4	1,8	B45196-H6685-+30*
	15	D	0,06	5,3	0,8	B45196-H6156-+40*
	22 33 ²⁾	E E	0,06 0,06	7,7 11,6	0,8 0,8	B45196-H6226-+50* B45196-H6336-+50*
50 (33)	0,15	A	0,04	0,5	22	B45196-H7154-+10*
	0,22	A	0,04	0,5	18	B45196-H7224-+10*
	0,47	B	0,04	0,5	9,0	B45196-H7474-+20*
	1,5	C	0,06	0,8	4,4	B45196-H7155-+30*
	6,8	E	0,06	3,4	0,8	B45196-H7685-+50*
	10 ²⁾	E	0,06	5,0	0,8	B45196-H7106-+50*

1) Replace 196 by 198 for gold-plated terminals
 + Insert code letter for required capacitance tolerance: M = $\pm 20\%$, K = $\pm 10\%$ (J = $\pm 5\%$ upon request)
 * Insert code number for required reel diameter: 9 = 180 mm, 6 = 330 mm

2) Upon request

**Technical data and ordering codes**For characteristic curves [see page 37/38 ff](#)

V_R up to 85 °C (up to 125 °C) Vdc	C_R μF	Case size	$\tan \delta_{\max}$ (20 °C, 120 Hz)	$I_{k, \max}$ (20 °C, V_R , 5 min) μA	Z_{\max} (20 °C, 100 kHz) Ω	Ordering code 1) Tinned terminals
4 (2,5)	3,3	A	0,045	0,5	5,9	B45196-P335-+10*
	4,7	A	0,045	0,5	4,6	B45196-P475-+10*
	6,8	A	0,045	0,5	3,9	B45196-P685-+10*
	10	B	0,045	0,5	2,7	B45196-P106-+20*
	15	B	0,045	0,6	2,6	B45196-P156-+20*
	22	C	0,045	0,9	1,7	B45196-P226-+30*
	33	C	0,045	1,3	1,5	B45196-P336-+30*
	47	C	0,045	1,9	1,1	B45196-P476-+30*
	68	D	0,045	2,7	0,8	B45196-P686-+40*
	100	D	0,06	4,0	0,6	B45196-P107-+40*
6,3 (4)	150	D	0,06	6,0	0,6	B45196-P157-+40*
	2,2	A	0,045	0,5	6,5	B45196-P1225-+10*
	3,3	A	0,045	0,5	4,6	B45196-P1335-+10*
	4,7	A	0,045	0,5	3,6	B45196-P1475-+10*
	6,8	B	0,045	0,5	2,7	B45196-P1685-+20*
	10	B	0,045	0,6	2,1	B45196-P1106-+20*
	15	C	0,045	1,0	1,7	B45196-P1156-+30*
	22	C	0,045	1,4	1,3	B45196-P1226-+30*
	33	C	0,045	2,1	1,1	B45196-P1336-+30*
	47	C	0,045	3,0	0,8	B45196-P1476-+30*
	47	D	0,045	3,0	0,8	B45196-P1476-+40*
	68	D	0,045	4,3	0,6	B45196-P1686-+40*
	100	D	0,06	6,3	0,6	B45196-P1107-+40*

Types B 45 196-P can be operated at temperatures up to 150 °C.

Details for this operating condition must be agreed upon between supplier and customer.

1) Replace 196 by 198 for gold-plated terminals

+ Insert code letter for required capacitance tolerance: M = $\pm 20\%$, K = $\pm 10\%$ (J = $\pm 5\%$ upon request)

* Insert code number for required reel diameter: 9 = 180 mm, 6 = 330 mm

**B 45 196-P**

V_R up to 85 °C (up to 125 °C) Vdc	C_R μF	Case size	$\tan \delta_{max}$ (20 °C, 120 Hz)	$I_{lk, max}$ (20 °C, V_R , 5 min) μA	Z_{max} (20 °C, 100 kHz) Ω	Ordering code 1) Tinned terminals
10 (6,3)	1,5	A	0,045	0,5	6,5	B45196-P2155-+10*
	2,2	A	0,045	0,5	4,6	B45196-P2225-+10*
	3,3	A	0,045	0,5	3,6	B45196-P2335-+10*
	4,7	B	0,045	0,5	2,7	B45196-P2475-+20*
	6,8	B	0,045	0,7	2,1	B45196-P2685-+10*
	10	B	0,045	1,0	1,8	B45196-P2106-+20*
	10	C	0,045	1,0	1,7	B45196-P2106-+30*
	15	C	0,045	1,5	1,4	B45196-P2156-+30*
	22	C	0,045	2,2	1,1	B45196-P2226-+30*
	33	D	0,045	3,3	0,8	B45196-P2336-+40*
	47	D	0,045	4,7	0,6	B45196-P2476-+40*
	68	D	0,045	6,8	0,6	B45196-P2686-+40*
	100	D	0,06	10	0,6	B45196-P2107-+40*
16 (10)	1,0	A	0,030	0,5	6,5	B45196-P3105-+10*
	1,5	A	0,045	0,5	5,2	B45196-P3155-+10*
	2,2	A	0,045	0,5	4,3	B45196-P3225-+10*
	3,3	B	0,045	0,6	3,0	B45196-P3335-+20*
	4,7	B	0,045	0,8	2,1	B45196-P3475-+20*
	6,8	C	0,045	1,1	1,7	B45196-P3685-+30*
	10	C	0,045	1,6	1,4	B45196-P3106-+30*
	15	C	0,045	2,4	1,1	B45196-P3156-+30*
	22	C	0,045	3,6	1,0	B45196-P3226-+30*
	22	D	0,045	3,6	0,8	B45196-P3226-+40*
	33	D	0,045	5,3	0,7	B45196-P3336-+40*
47	D	0,045	7,5	0,6	B45196-P3476-+40*	

Types B 45 196-P can be operated at temperatures up to 150 °C.

Details for this operating condition must be agreed upon between supplier and customer.

1) Replace 196 by 198 for gold-plated terminals

+ Insert code letter for required capacitance tolerance: M = $\pm 20\%$, K = $\pm 10\%$ (J = $\pm 5\%$ upon request)

* Insert code number for required reel diameter: 9 = 180 mm, 6 = 330 mm



V_R up to 85 °C (up to 125 °C) Vdc	C_R μF	Case size	$\tan \delta_{max}$ (20 °C, 120 Hz)	$I_{lk, max}$ (20 °C, V_R , 5 min) μA	Z_{max} (20 °C, 100 kHz) Ω	Ordering code 1) Tinned terminals
20 (13)	0,68	A	0,030	0,5	7,8	B45196-P4684-+10*
	1,0	A	0,030	0,5	5,9	B45196-P4105-+10*
	1,5	A	0,045	0,5	5,2	B45196-P4155-+10*
	2,2	B	0,045	0,5	3,6	B45196-P4225-+20*
	3,3	B	0,045	0,7	2,7	B45196-P4335-+20*
	4,7	C	0,045	1,0	1,7	B45196-P4475-+30*
	6,8	C	0,045	1,4	1,3	B45196-P4685-+30*
	10	C	0,045	2,0	1,1	B45196-P4106-+30*
	15	D	0,045	3,0	0,9	B45196-P4156-+40*
	22	D	0,045	4,4	0,7	B45196-P4226-+40*
25 (16)	33	D	0,045	6,6	0,6	B45196-P4336-+40*
	0,47	A	0,030	0,5	8,5	B45196-P5474-+10*
	0,68	A	0,030	0,5	6,5	B45196-P5684-+10*
	1,0	A	0,030	0,5	5,2	B45196-P5105-+10*
	1,5	B	0,045	0,5	4,2	B45196-P5155-+20*
	2,2	B	0,045	0,6	3,0	B45196-P5225-+20*
	3,3	C	0,045	0,9	2,0	B45196-P5335-+30*
	4,7	C	0,045	1,2	1,6	B45196-P5475-+30*
	6,8	C	0,045	1,7	1,4	B45196-P5685-+30*
	10	C	0,045	2,5	1,1	B45196-P5106-+30*
10	D	0,045	2,5	0,9	B45196-P5106-+40*	
15	D	0,045	3,8	0,7	B45196-P5156-+40*	
22	D	0,045	5,5	0,6	B45196-P5226-+40*	

Types B 45 196-P can be operated at temperatures up to 150 °C.

Details for this operating condition must be agreed upon between supplier and customer.

1) Replace 196 by 198 for gold-plated terminals

+ Insert code letter for required capacitance tolerance: M = $\pm 20\%$, K = $\pm 10\%$ (J = $\pm 5\%$ upon request)

* Insert code number for required reel diameter: 9 = 180 mm, 6 = 330 mm

**B 45 196-P**

V_R up to 85 °C (up to 125 °C) Vdc	C_R μF	Case size	$\tan \delta_{max}$ (20 °C, 120 Hz)	$I_{k, max}$ (20 °C, V_R , 5 min) μA	Z_{max} (20 °C, 100 kHz) Ω	Ordering code 1) Tinned terminals
35 (23)	0,10	A	0,030	0,5	28	B45196-P6104-+10*
	0,15	A	0,030	0,5	23	B45196-P6154-+10*
	0,22	A	0,030	0,5	15	B45196-P6224-+10*
	0,33	A	0,030	0,5	11	B45196-P6334-+10*
	0,47	B	0,030	0,5	8,0	B45196-P6474-+20*
	0,68	B	0,030	0,5	5,5	B45196-P6684-+20*
	1,0	B	0,030	0,5	4,4	B45196-P6105-+20*
	1,5	C	0,045	0,6	3,3	B45196-P6155-+30*
	2,2	C	0,045	0,8	2,2	B45196-P6225-+30*
	3,3	C	0,045	1,2	1,7	B45196-P6335-+30*
	4,7	D	0,045	1,7	1,0	B45196-P6475-+40*
	6,8	D	0,045	2,4	0,9	B45196-P6685-+40*
10	D	0,045	3,5	0,7	B45196-P6106-+40*	
50 (33)	0,10	A	0,030	0,5	27	B45196-P7104-+10*
	0,15	B	0,030	0,5	22	B45196-P7154-+20*
	0,22	B	0,030	0,5	15	B45196-P7224-+20*
	0,33	B	0,030	0,5	11	B45196-P7334-+20*
	0,47	C	0,030	0,5	6,5	B45196-P7474-+30*
	0,68	C	0,030	0,5	5,5	B45196-P7684-+30*
	1,0	C	0,030	0,5	3,3	B45196-P7105-+30*
	1,5	D	0,045	0,8	2,8	B45196-P7155-+40*
	2,2	D	0,045	1,1	2,0	B45196-P7225-+40*
	3,3	D	0,045	1,7	1,1	B45196-P7335-+40*
	4,7	D	0,045	2,4	0,9	B45196-P7475-+40*

Types B 45 196-P can be operated at temperatures up to 150 °C.

Details for this operating condition must be agreed upon between supplier and customer.

1) Replace 196 by 198 for gold-plated terminals

+ Insert code letter for required capacitance tolerance: M = $\pm 20\%$, K = $\pm 10\%$ (J = $\pm 5\%$ upon request)

* Insert code number for required reel diameter: 9 = 180 mm, 6 = 330 mm



Technical data and ordering codes

For characteristic curves [see page 37/40 ff](#)

V_R up to 85°C (up to 125°C) Vdc	C_R μF	Case size	$\tan \delta_{\max}$ (20°C, 120 Hz)	$I_{k, \max}$ (20°C, V_R , 5 min) μA	ESR_{\max} (20°C, 100 kHz) $\text{m}\Omega$	I_{ac} (20°C, 100 kHz) A	Ordering code ¹⁾ Tinned terminals
6,3 (4)	22	C	0,06	1,4	375	0,54	B45197-A1226--+30*
	33	C	0,06	2,1	350	0,56	B45197-A1336--+30*
	68	D	0,06	4,3	175	0,93	B45197-A1686--+40*
	100	D	0,08	6,3	125	1,10	B45197-A1107--+40*
	150	E	0,08	9,5	100	1,28	B45197-A1157--+50*
	220	E	0,08	13,9	100	1,28	B45197-A1227--+50*
	330	E	0,08	20,8	100	1,28	B45197-A1337--+50*
10 (6,3)	15	C	0,06	1,5	400	0,52	B45197-A2156--+30*
	22	C	0,06	2,2	375	0,54	B45197-A2226--+30*
	47	D	0,06	4,7	200	0,87	B45197-A2476--+40*
	68	D	0,06	6,8	150	1,00	B45197-A2686--+40*
	100	D	0,08	10	100	1,22	B45197-A2107--+40*
	100	E	0,08	10	100	1,28	B45197-A2107--+50*
	150	E	0,08	15	100	1,28	B45197-A2157--+50*
	220	E	0,08	22	100	1,28	B45197-A2227--+50*
16 (10)	330	E	0,08	33	100	1,28	B45197-A2337--+50*
	10	C	0,06	1,6	450	0,49	B45197-A3106--+30*
	15	C	0,06	2,4	400	0,52	B45197-A3156--+30*
	33	D	0,06	5,3	200	0,87	B45197-A3336--+40*
	47	D	0,06	7,5	175	0,93	B45197-A3476--+40*
	68	E	0,06	10,9	150	1,05	B45197-A3686--+50*
20 (13)	100	E	0,08	16	100	1,28	B45197-A3107--+50*
	6,8	C	0,06	1,4	475	0,48	B45197-A4685--+30*
	10	C	0,06	2,0	450	0,49	B45197-A4106--+30*
	22	D	0,06	4,4	200	0,87	B45197-A4226--+40*
	33	D	0,06	6,6	200	0,87	B45197-A4336--+40*
	33	E	0,06	6,6	200	0,91	B45197-A4336--+50*
	47	E	0,06	9,4	150	1,05	B45197-A4476--+50*
	68	E	0,06	13,6	150	1,05	B45197-A4686--+50*

1) Replace 197-A by 198-R for gold-plated terminals

+ Insert code letter for required capacitance tolerance: M = $\pm 20\%$, K = $\pm 10\%$ (J = $\pm 5\%$ upon request)

* Insert code number for required reel diameter: 9 = 180 mm, 6 = 330 mm



B 45 197-A

V_R up to 85°C (up to 125°C) Vdc	C_R μF	Case size	$\tan \delta_{\max}$ (20°C, 120 Hz)	$I_{k, \max}$ (20°C, V_R , 5 min) μA	ESR_{\max} (20°C, 100 kHz) $\text{m}\Omega$	I_{ac} (20°C, 100 kHz) A	Ordering code ¹⁾ Tinned terminals
25 (16)	4,7	C	0,06	1,2	525	0,46	B45197-A5475--30*
	15	D	0,06	3,8	230	0,81	B45197-A5156--40*
	22	D	0,06	5,5	230	0,81	B45197-A5226--40*
	22	E	0,06	5,5	230	0,85	B45197-A5226--50*
	33	E	0,06	8,3	200	0,91	B45197-A5336--50*
35 (23)	3,3	C	0,06	1,2	550	0,45	B45197-A6335--30*
	4,7	D	0,06	1,6	300	0,71	B45197-A6475--40*
	6,8	D	0,06	2,4	300	0,71	B45197-A6685--40*
	6,8	E	0,06	2,4	300	0,74	B45197-A6685--50*
	10	D	0,06	3,5	260	0,76	B45197-A6106--40*
	10	E	0,06	3,5	260	0,80	B45197-A6106--50*
	15	D	0,06	5,3	260	0,76	B45197-A6156--40*
	15	E	0,06	5,3	260	0,80	B45197-A6156--50*
	22	E	0,06	7,7	260	0,80	B45197-A6226--50*
50 (33)	4,7	D	0,06	2,4	300	0,71	B45197-A7475--40*
	6,8	E	0,06	3,4	300	0,74	B45197-A7685--50*

1) Replace 197-A by 198-R for gold-plated terminals

+ Insert code letter for required capacitance tolerance: M = $\pm 20\%$, K = $\pm 10\%$ (J = $\pm 5\%$ upon request)

* Insert code number for required reel diameter: 9 = 180 mm, 6 = 330 mm



Impedance Z and equivalent series resistance ESR versus temperature T
Typical behavior

Case sizes A to E

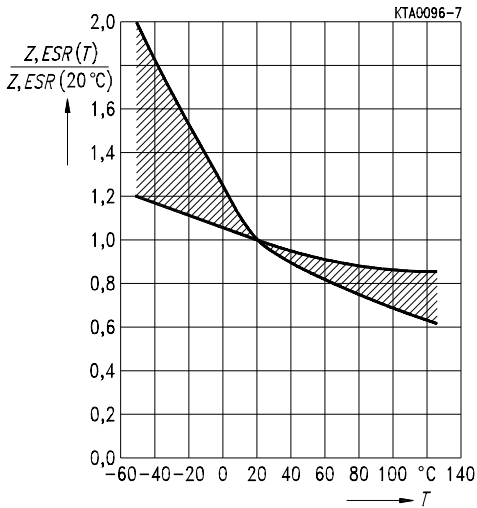



B 45 196
B 45 198

Impedance Z and equivalent series resistance ESR versus frequency f
Typical behavior

Case size A

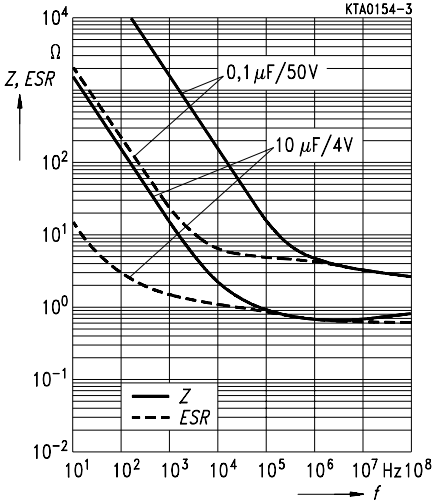

Case size B

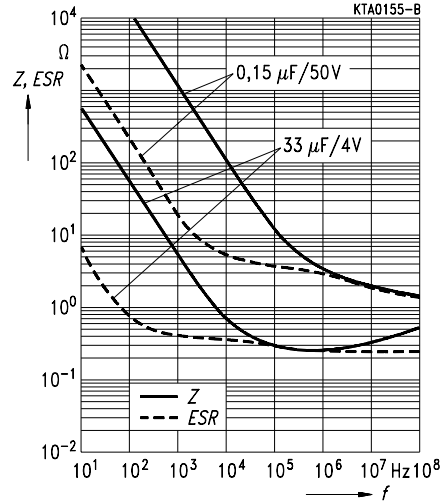

Case size C

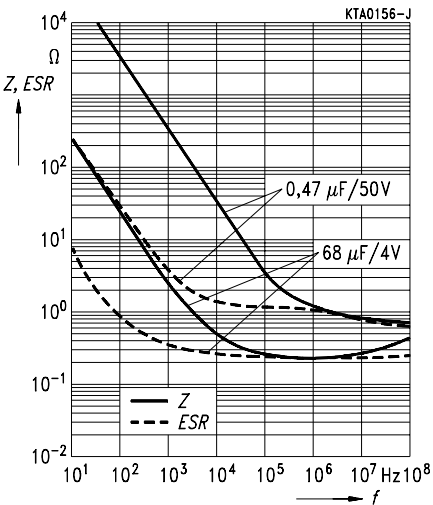

Case size D

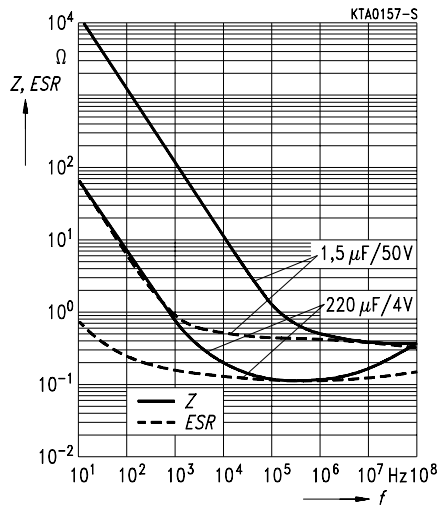



Impedance Z and equivalent series resistance ESR versus frequency f
Typical behavior

Case size E

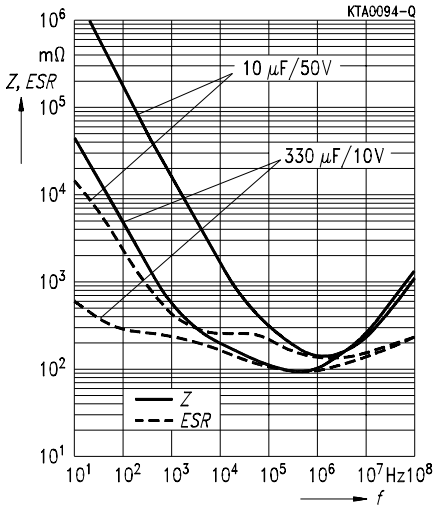



B 45 197-A
B 45 198-R

Impedance Z and equivalent series resistance ESR versus frequency f
Typical behavior

Case size C

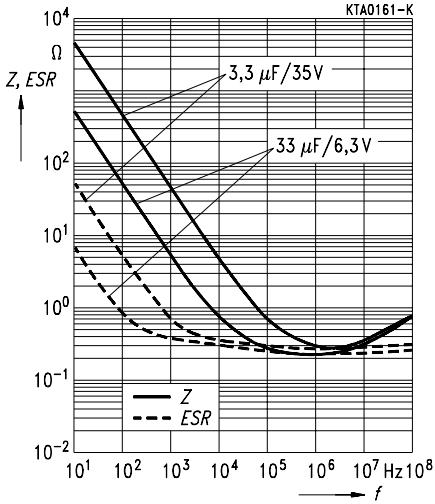

Case size D

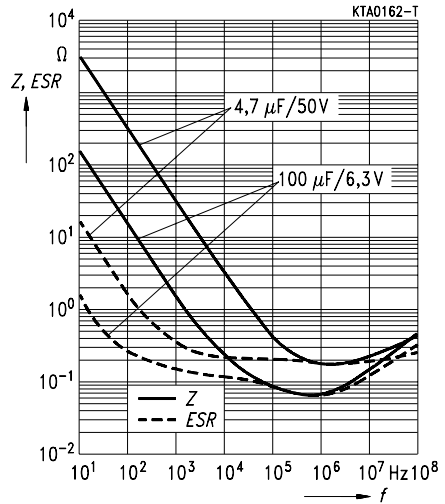

Case size E

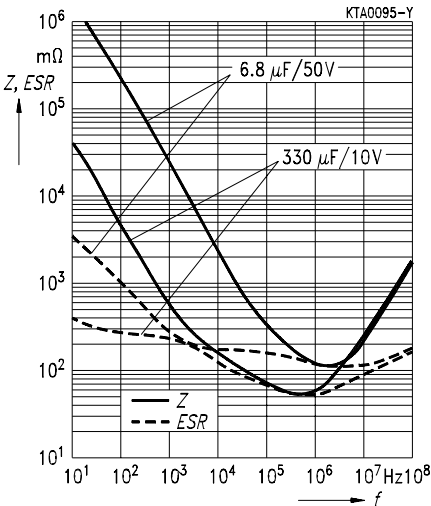



Permissible ripple current
versus temperature T
Typical behavior

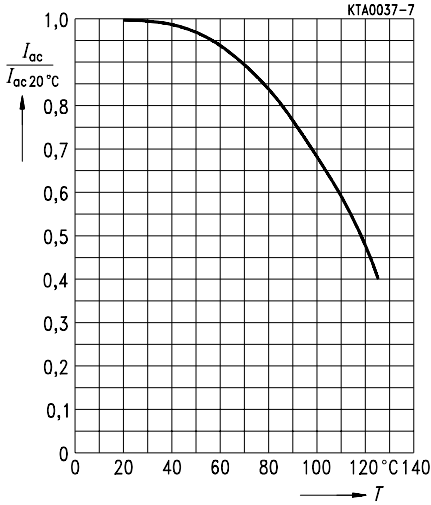

Permissible ripple current
versus frequency f
Typical behavior

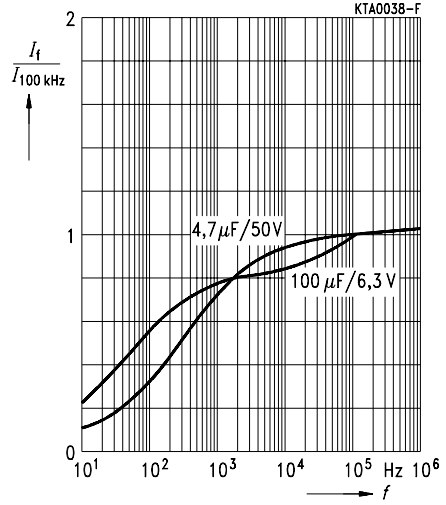



Siemens Matsushita Components

Ceramic chip capacitors from stock

Small in size, big in performance

Our selection of capacitors ranges from standard sizes down to a miniature highlight in 0402 style. Measuring only 1 x 0.5 x 0.5 mm, it's an ideal solution for applications where space is tight, like in handies and cardiac pacemakers. At the same time all our chips can boast excellent soldering characteristics, with special terminal variants for conductive adhesion. And we also thought about the right packing for automatic placement. You get all sizes down to 1206 in bulk case for example, plus voltage ratings from 16 to 500 V. By the way, our leaded models have CECC approval of course, in fact they were certified more than ten years ago.

More in the new short form catalog!



SCS - dependable, fast and competent



General Technical Information

1 Basic construction

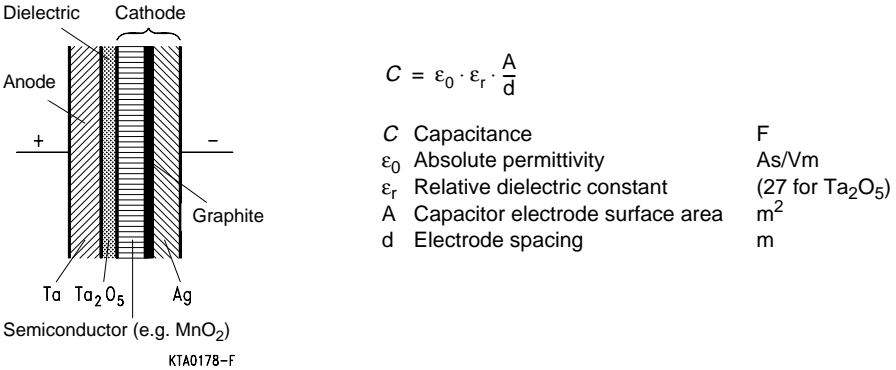

Fig. 1 Basic construction of a tantalum capacitor and calculation of capacitance

Anode	Body of sintered tantalum powder
Dielectric	Tantalum oxide, generated electrochemically by oxidation on the anode
Cathode	Semi-conducting metal oxide (manganese dioxide) deposited on the anodic oxide foil
Contacts to the cathode	Graphite and conducting silver layer that is applied on the semi-conducting coating and soldered or glued to the case or the terminals

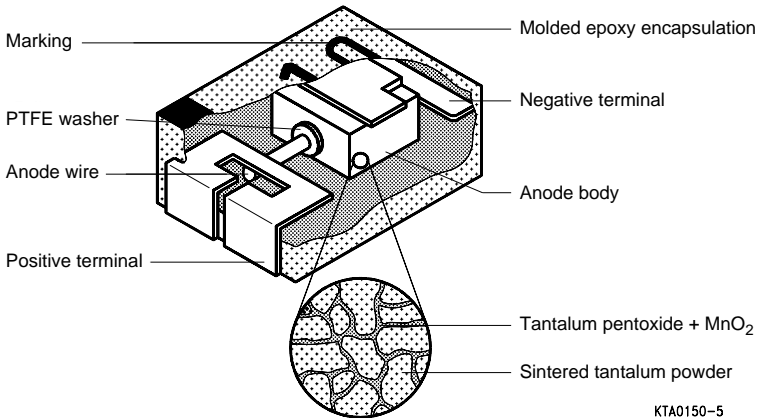

Fig. 2 Mechanical construction

General Technical Information

2 Polarity

Tantalum electrolytic capacitors are polar capacitors. The dielectric layers of polar electrolytic capacitors are arranged so that the current is blocked only in one direction. It is important, therefore, to pay attention to the polarity marking (positive pole on anode, negative pole on cathode). Reverse polarity is permitted only up to the values indicated on page 47, otherwise the capacitor may be destroyed by the effects of the rapidly increasing current.

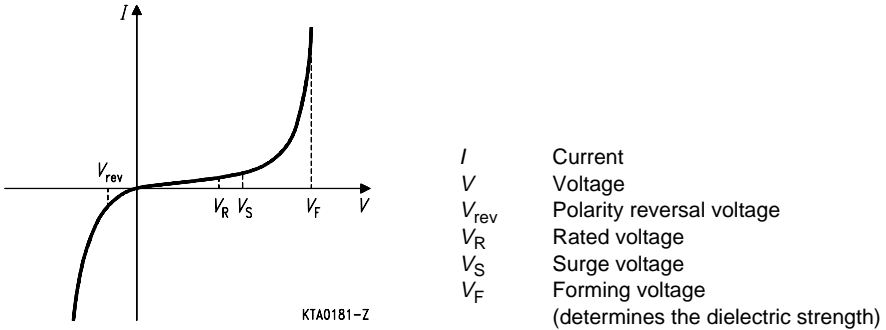

Fig. 3 Current/voltage curve of a tantalum electrolytic capacitor (qualitative depiction only)

3 Standards

The tantalum electrolytic capacitors described in this data book are all designed for enhanced service requirements. The mechanical and electrical characteristics, together with the corresponding tests and test procedures, are set down in the appropriate standards. With regard to the technical content, the general IEC, CECC and DIN standards are in line with each other.

General standards for tantalum electrolytic capacitors

IEC 384-1	(identical with DIN IEC 384, part 1, CECC30000 and DIN 45 910) Generic specification: Fixed capacitors for use in electronic equipment
IEC 384-3	(identical with DIN IEC 384, part 3, CECC30800 and DIN 45 910 part 15) Sectional specification: Tantalum chip capacitors
IEC 384 - 3-1	(identical with DIN IEC 384, part 3-1 and CECC30801) Blank detail specification: Tantalum chip capacitors

Assignment of tantalum electrolytic capacitors produced by S + M Components to existing detail specifications

Detail specification	Series
CECC30801-801	B 45 196-E, B 45 196-P
IEC-QC300801/US0001	B 45 196-E, B 45 196-P
CECC30801-802	B 45 196-H
CECC30801-011	B 45 196-Q (special version)
CECC30801-805	B45197

4 Voltages

4.1 Rated voltage

The rated voltage V_R is the dc voltage indicated upon the capacitor. It determines the thickness of the dielectric.

4.2 Maximum continuous voltage

The maximum continuous voltage V_{cont} is the maximum permissible voltage at which the capacitor can be continuously operated. It is a direct current voltage, or the sum of the basic dc voltage plus the peak value of the superimposed ac voltage (cf. chapter 7, on page 52).

The maximum continuous voltage depends on the ambient temperature (cf. figure 4). Within the temperature range of -55 to $+85$ °C, the rated voltage is equal to the maximum continuous voltage for tantalum electrolytic capacitors.

In the temperature range between $+85$ and $+125$ °C, the maximum continuous voltage must be reduced linearly from the rated voltage to $2/3$ of the rated voltage. 85 °C at V_R and 125 °C at $2/3 V_R$ constitute approximately the same load for the capacitor. Operation below the maximum continuous voltage has a positive effect on the capacitor's service life.

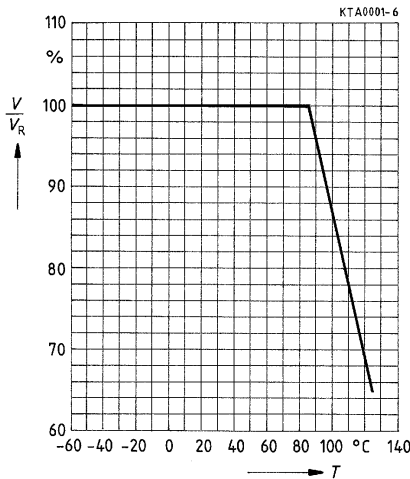

Fig. 4 Max. permissible continuous voltage (operating voltage) versus temperature

4.3 Operating voltage

The operating voltage V_{op} is the voltage applied to the capacitor during continuous operation. It is not allowed to exceed the max. continuous voltage.

All unfavorable operating conditions (e.g. possible line overvoltages, unfavorable tolerances of the transformation ratio of the line transformer in the equipment, repeated overvoltages upon switching equipment on, high ambient temperatures etc.) have to be taken into account when determining the operating voltage.

4.4 Surge voltage

The surge voltage V_S is the maximum voltage (peak value) which may be applied to the capacitor for short periods, at the most 5 times for a duration of up to 1 minute per hour. The surge voltage must not be applied for periodic charging and discharging in the course of normal operation.

The permissible surge voltage for all capacitors in this data book is

$$1,3 \cdot V_R$$

If voltage impulses (transient voltages) exceeding the surge voltage occur, this may lead to irreparable damage.

If applications of this kind are planned, please consult us first.

4.5 Polarity reversal voltage (incorrect polarity)

Any incorrect polarity resulting from the sum of the direct voltage and the alternating voltage components must be smaller than or equal to the permitted polarity reversal voltage (see table below). To avoid reducing the reliability, this voltage may only occur for a short time, at most five times for a duration of one minute per hour.

Permissible polarity reversal voltage for capacitors with a solid electrolyte:

at 20 °C:	$0,15 \cdot V_R$
at 55 °C:	$0,10 \cdot V_R$
at 85 °C:	$0,05 \cdot V_R$
at 125 °C:	$0,03 \cdot V_R$

4.6 Series back-to-back connection

For applications where higher polarity reversal voltages occur, two capacitors with identical rated voltage and identical rated capacitance can be connected back-to-back in series (e.g. cathode to cathode). In this way, blocking in each polarization direction is achieved. To avoid damage to the reversed polarity capacitors during charging, it is necessary to connect diodes in parallel to the capacitors with the center of the diodes and the capacitors connected together.

This non-polar or bi-polar version (which only has half the capacitance value as a result) can be operated at voltages of up to the rated direct voltage of any polarity or with double the superimposed alternating voltage of the value permitted for the individual capacitor.

The capacitors connected back-to-back in this way can also be operated at a pure ac voltage. The surface temperature of the capacitor is not allowed to increase by more than max. 10 °C, while the upper temperature limit should not be exceeded.

4.7 Inherent voltage

Occasionally, inherent voltages can occur in electrolytic capacitors (due to element formation between anode and cathode). Since these inherent voltages are relatively low (< 0,5 V), with accordingly high internal resistance (several $10^6 \Omega$), they are of no importance for most applications.

4.8 Recharging

In all conventional capacitors a recharging effect may occur. This effect causes a charged capacitor to generate a recharging voltage that is of the same polarity as the charging voltage after external bridges are removed from the capacitor's layers. The recharging voltage is more or less independent of the capacitance of the capacitors and the thickness of the dielectric and can be considered to be a characteristic property of the dielectric material.

The value of the recharging voltage depends on various factors (type, charging time, discharging time, time of measurement, ambient temperature) and can attain an order of magnitude of 10^{-2} up to several tenths of the operating voltage. Of all electrolytic capacitors, capacitors with solid electrolytes have the lowest recharging effect.

5 Capacitance

5.1 Rated capacitance

The rated capacitance C_R is the capacitance value by which the capacitor is identified. The actual capacitance of a capacitor can deviate from the rated capacitance by as much as the full magnitude of the tolerance at delivery.

The capacitance of tantalum electrolytic capacitors is determined at a frequency of 120 Hz and a temperature of 20 °C as a series capacitance in an alternating current bridge circuit with measuring voltages $< 0,5 V_{rms}$.

5.2 Capacitance tolerance

The capacitance tolerance (or tolerance at delivery) $\Delta C/C_R$ is the maximum permitted deviation of the actual capacitance value from the specific rated capacitance.

Where the capacitance tolerances are to be indicated on the components themselves, S + M Components uses code letters in accordance with IEC 68. This code letter also forms part of the ordering code.

5.3 Temperature dependence of the capacitance

The capacitance of a tantalum electrolytic capacitor varies with the temperature (positive temperature coefficient), cf. figure 5. The amount by which it varies depends on the voltage and capacitance value. Low voltages and high capacitance values cause greater variations than high voltages and low capacitance values.

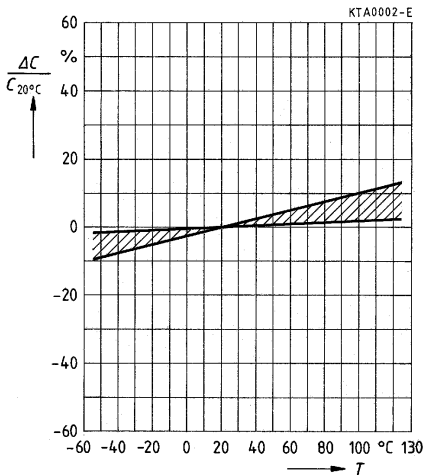

Fig. 5 Capacitance change versus temperature (typical values)

	- 55 °C	+ 85 °C	+ 125 °C
Maximum values for chip capacitors	- 10 %	+ 10 %	+ 12 %

5.4 Frequency dependence of the capacitance

The capacitance decreases with increasing frequency. A typical curve is shown in [figure 6](#).

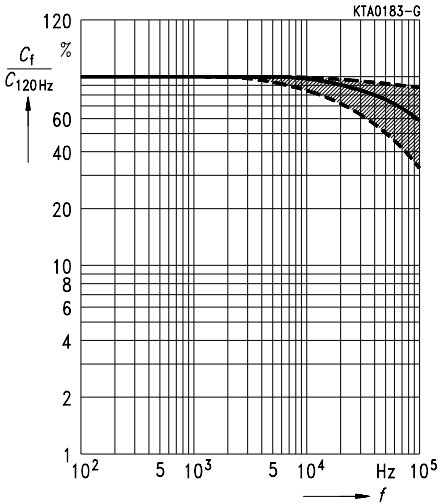

Fig. 6 Capacitance change versus frequency (typical behavior), reference temperature 20 °C

Typical values of the effective capacitance can be derived from the impedance curve, as long as the impedance is still in the range where the capacitive component dominates.

$$C = \frac{1}{2 \cdot \pi \cdot f \cdot Z}$$

- C Capacitance F
- f Frequency Hz
- Z Impedance Ω

5.5 Charge-discharge proof

Tantalum electrolytic capacitors produced by S + M Components are charge-discharge proof. This means that the capacitance reduction after 10^8 charge-discharge cycles will be less than 3 %.

6 Impedance / Equivalent series resistance (ESR)

The impedance can also be described as the absolute value of the ac resistance.

The impedance of tantalum electrolytic capacitors is represented in close approximation by a series circuit comprising the following individual resistance components:

1. Effective reactance $1/\omega C$ of the capacitance C
2. Dielectric losses and the ohmic resistance of the electrolyte and/or the semiconductor layer (equivalent series resistance ESR)
3. Effective reactance ωL of the inductance of the electrodes and the terminals.

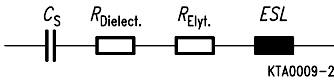

Fig. 7 Simplified equivalent circuit diagram of a tantalum electrolytic capacitor

The frequency and temperature relationship of these components determine the impedance characteristics.

ESR includes both $R_{\text{Dielect.}} + R_{\text{Elyt.}}$: $R_{\text{Dielect.}}$ represents the dielectric losses and decreases with $1/\omega$. R_{elyte} represents the series resistance of the electrolyte and does not vary with frequency. $R_{\text{Dielect.}}$ is negligible at frequencies above approximately 10 kHz.

In the higher and lower frequency ranges, the frequency characteristic of the impedance is mainly caused by both the reactances. The temperature characteristic is mainly determined by the resistance of the electrolyte.

Because of the corrosion-resistance of tantalum, highly conductive electrolytes can be used for tantalum electrolytic capacitors, so that these capacitors have low series resistances. A particularly high conductivity is achieved by the solid semiconductor layer used instead of a liquid electrolyte. Hence capacitors with solid electrolytes have the lowest series resistance of all electrolytic capacitors.

The conductivity of the electrolyte varies only slightly, even at low temperatures. This means that the impedance of tantalum electrolyte capacitors displays favorable frequency and temperature characteristics.

The following figures show the typical behavior of the impedance in relationship to frequency and temperature.

The decrease in impedance at low frequencies down to a few kHz is determined by the capacitive reactance, whereas the following, almost horizontal course of the curve mainly shows the ohmic series resistance. Beyond the natural resonant frequency, the inductive reactance becomes increasingly predominant, so that the curves finally merge into straight lines.

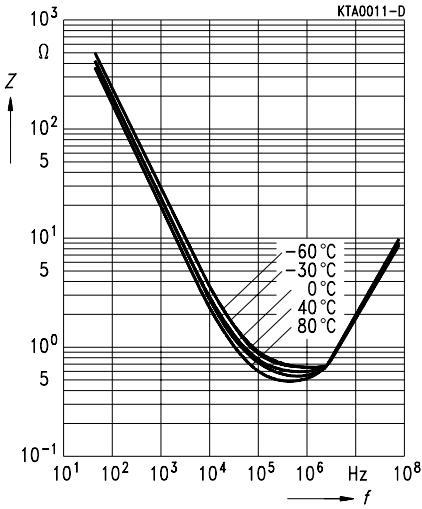

Fig. 8 Impedance Z versus frequency f
Capacitor $6,8 \mu\text{F}/35 \text{ Vdc}$

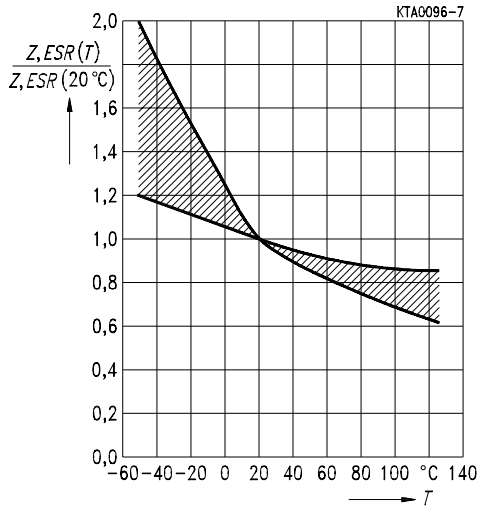

Fig. 9 Impedance Z versus temperature T

General Technical Information

7 AC power dissipation

7.1 Superimposed alternating voltage for capacitors with solid electrolyte

The superimposed alternating voltage is the r.m.s. alternating voltage that may be applied to a capacitor in addition to a direct voltage. The sum of the direct voltage and the peak value of the superimposed alternating voltage must not exceed the maximum continuous voltage. The superimposed alternating voltage must be limited in such a way that no unpermitted incorrect polarity occurs (permissible incorrect polarity, cf. chapter 4.5).

The alternating current flowing through the capacitor or the alternating voltage applied may not exceed a maximum value determined for the respective type and rated capacitance, since the capacitor might be damaged due to overheating or its service life may be reduced. The value of the permitted alternating voltage and/or the superimposed alternating current depends on the equivalent series resistance (ESR) and the permissible power dissipation. Here, the permitted inherent heating for the respective type is taken into consideration.

The basis for the calculations are as follows:

$$P = I^2 \cdot ESR, \text{ with } I = \frac{V}{Z} \text{ we obtain}$$

$$P = \frac{V^2 \cdot ESR}{Z^2}$$

P	Power dissipation	W
I	Effective ripple current	A
V	Effective alternating voltage	Vac
Z	Impedance	Ω
ESR	Equivalent series resistance	Ω

7.2 Maximum permissible ripple current and alternating voltage loads

Using P_{\max} from the following tables, the maximum permissible ripple current and alternating voltage loads can be calculated.

$$I_{\max} = \sqrt{\frac{P_{\max}}{ESR}} \qquad V_{\max} = Z \sqrt{\frac{P_{\max}}{ESR}}$$

7.2.1 Maximum permissible power dissipation with ripple current load

Case size	Z	P	A	B	C	D	E
$P_{V \max}$ in mW	28	55	75	85	110	150	165

Reduction of the calculated values versus the ambient temperature, cf. figure 10.

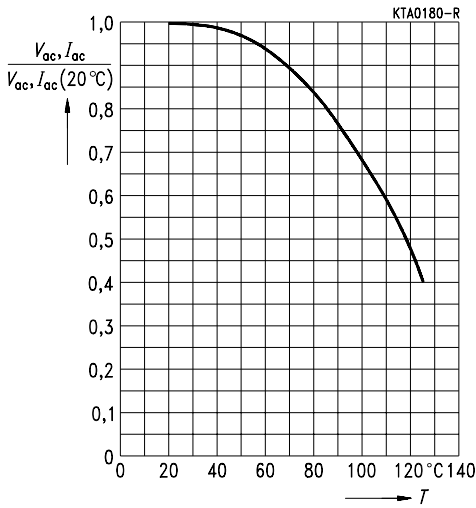

Fig. 10 Permissible ripple current I_{ac} and permissible alternating voltage V_{ac} versus temperature T

8 Dissipation factor

The dissipation factor $\tan \delta$ increases with frequency and tends to very high values at near-resonance frequencies. The figures below show the typical frequency and temperature behavior of the dissipation factor.

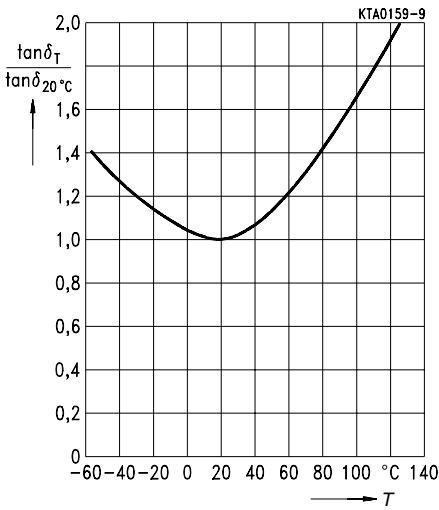

Fig. 11 Dissipation factor versus temperature at $f = 120$ Hz

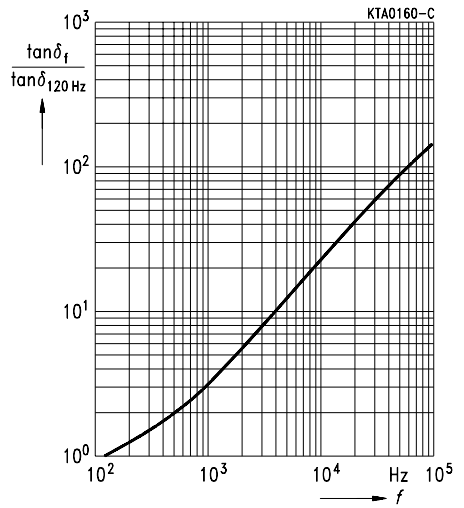

Fig. 12 Dissipation factor versus frequency at $T = 20$ °C

9 Leakage current

When a direct voltage is applied to electrolytic capacitors, a low, constant current will flow through any capacitor. This so-called leakage current I_{lk} is a function of the voltage as well as of the temperature. (Graphs are shown in [chapter 9.1](#)).

The value of the leakage current of an electrolytic capacitor is determined, above all, by the impurities (atoms of foreign substances that cannot be formed) in the carrier metal (anode). The use of high-purity tantalum powder results in a low fault density in the dielectric and thus in a low leakage current.

9.1 Temperature and voltage dependence of the leakage current

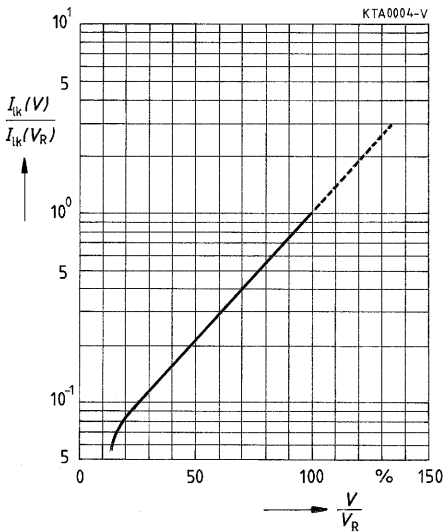

Fig. 13 Leakage current versus voltage

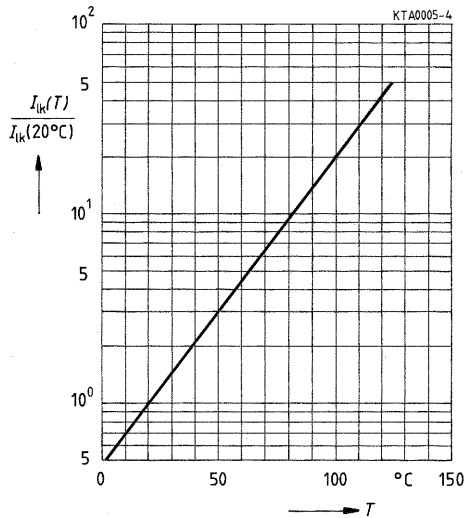

Fig. 14 Leakage current versus temperature

9.2 Time dependence of the leakage current

As can be seen from [figure 15](#), the leakage current is high when the voltage is first applied (inrush current). This decreases rapidly, however, in the course of operation and finally achieves an almost constant “steady-state” value.

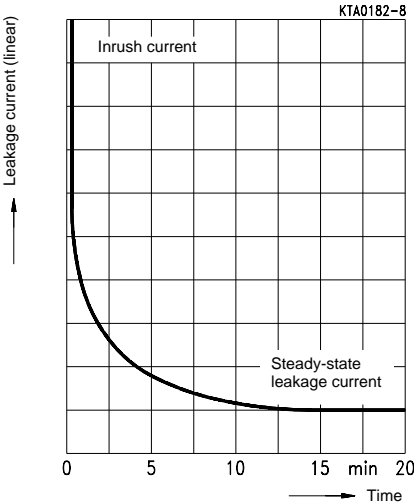

Fig. 15 Leakage current versus time for which a voltage is applied

9.3 Leakage current measurement

The leakage current is measured at 20 °C, after the rated voltage has been applied to the capacitors for five minutes. A stabilized power supply is required and a series resistor of 1000 Ω should be connected in order to limit the charging current.

Before the voltage is applied, the capacitors must be stabilized at the rated temperature for 30 minutes.

For tantalum capacitors with solid electrolyte, the following limit value at 20 °C is required by the applicable standards:

$$I_{lk} \leq 0,01 \mu\text{A} \cdot \left(\frac{C_R}{\mu\text{F}} \cdot \frac{V_R}{V} \right), \text{ minimum } 0,5 \mu\text{A}.$$

The following temperature factors apply

at 85 °C: 10

at 125 °C: 12,5

9.4 Leakage current behavior after storage without applied voltage

Tantalum and its oxide are extremely resistant to chemical influences and are only attacked by very aggressive chemicals. They possess a high resistance to commonly used electrolytes and there is no deterioration of the oxide layer.

Storage without an applied voltage at room temperature has no effect on the leakage current and only a slight effect at increased storage temperatures. This means that tantalum electrolytic capacitors can be stored for at least 10 years without requiring subsequent regeneration.

10 Resistance to climatic stress

Both for reasons of reliability and due to the fact that the electrical parameters vary with temperature, limits must be set for the climatic conditions to which tantalum capacitors are subjected. The most important climatic factors are the permissible minimum and maximum temperatures and humidity conditions. The values for these three factors are coded as IEC climatic categories (cf. [chapter 10.5](#)). The IEC category applicable to each type is given in the corresponding data sheet.

10.1 Temperature range

The temperature range of a capacitor is the range between the lower and upper category temperatures within which the capacitor may be operated in accordance with its climatic category.

The temperature range for tantalum electrolytic capacitors lies between -55 and $+125$ °C.

Within the -55 to $+85$ °C range, the maximum continuous voltage V_{cont} may be equal to the rated voltage V_R , provided that no other limiting conditions are specified. From 85 °C upwards, voltage reductions should be made (cf. [chapter 4.2](#)).

10.2 Minimum permissible operating temperature T_{min} (Lower category temperature)

The lower category temperature results from the capacitance decrease permitted for each individual capacitor type or from the increase in impedance due to the reduced conductivity of the electrolyte or the semiconductor layer. Temperatures down to the lower category temperature do not affect the service life.

10.3 Maximum permissible operating temperature T_{max} (Upper category temperature)

The upper category temperature is the maximum permissible ambient temperature at which a capacitor may be continuously operated at the stated permissible electrical load. If this limit is exceeded, the capacitor may fail prematurely. It is possible to exceed the upper category temperature for short periods. However, since the permissible period depends on the electrical load, it is essential to consult S + M Components before implementing such applications.

10.4 Damp heat conditions

The permissible damp heat conditions for tantalum electrolytic capacitors are specified by the climatic categories in accordance with IEC 68-1 and are proved by tests in accordance with IEC 68-2-3.

General Technical Information

10.5 IEC climatic category

The permissible climatic stress on a capacitor is given by the respective IEC climatic category. According to IEC 68-1, the climatic category comprises 3 groups of numbers, separated by slashes.

Example: 55/125/56

1st group: Lower category temperature (temperature limit) denoting the test temperature for test A (cold) in accordance with IEC 68-2-1.

2nd group: Upper category temperature (temperature limit) denoting the test temperature for test B (dry heat) in accordance with IEC 68-2-2.

3rd group: Number of days, the duration of test Ca (damp heat, steady state) at a relative humidity of 93 +2/-3 % and an ambient temperature of 40 °C, in accordance with IEC 68-2-3.

10.6 Storage and transportation temperatures

Tantalum capacitors with solid electrolyte may be stored at temperatures down to – 80 °C.

The upper storage temperature may not exceed the rated temperature range.

11 Notes on mounting

For soldering tests, refer to the chapters “[Measuring and Test Conditions](#)” and “[Soldering Conditions](#)”. These chapters also include layout recommendations and soldering temperature profiles.

11.1 Cleaning agents

The cleaning agents normally used nowadays for cleaning printed circuit boards after components have been soldered in can also be used, without restrictions, for tantalum electrolytic capacitors. Four-chamber ultrasonic cleaning processes with short individual stages and adequate subsequent drying provide good protection against damage.

12 Standard barcode label

The standard product package label provides barcode information as well as the usual text information. This provides advantages in the internal goods flow, but above all, it allows fast and accurate identity monitoring by the customer.

Due to our systematically constructed, unique marking on the packages, each component can be traced back to a certain production lot. This, in turn allows monitoring of the entire production procedure right back to the purchasing of raw materials.

The information includes the type, ordering code, quantity, date of manufacture, storage number, lot number and, where applicable, customer number. The barcode used is code 39 (medium density).

Example:



13 Packing

When packing our products, naturally we pay attention to the needs of the environment. This means that:

- only environmentally compatible materials are used for packing, and
- the amount of packing is kept to an absolute minimum.

In observing these rules, we are also complying to German packaging legislation.

In order to further comply to the aims of this legislation concerning the reduction of commercial waste, we have implemented the following measures:

- Standardized “Euro” pallets are used.
- Goods are secured on pallets using straps and edge protectors made of environmentally compatible plastics (PE or PP). No stretch or shrink-wrap foils are used.
- Shipping cartons (transport packaging) qualify for and carry the RESY logo.
- Separating layers between pallets and cartons are of a single material type, preferably paper or cardboard.
- Styrofoam (expanded polystyrene foam) chips are used as filler and padding materials. These can be re-used. They are expanded to a foam without using CFCs and halogens.
- The shipping cartons are sealed with paper adhesive tape in order to ensure that only a single, uniform material needs to be disposed of.
- We are prepared, in principle, to take back the packing material (especially product-specific plastic packages). However, we ask our customers to send cardboard cartons, corrugated cardboard, paper etc. to recycling or disposal companies in order to avoid unnecessary transportation of empty packing materials.

14 End of use and disposal

All tantalum electrolytic capacitors produced by S + M Components are free of substances listed in German chemicals and CFC halogen prohibitive regulations. Nor do they contain any chemical substances of groups I through VIII of the Montreal clean air agreement or mentioned in EC regulation 3093/94.

Tantalum electrolytic capacitors are not categorized as waste materials requiring special supervision in recycling and waste disposal regulations. Consequently they may be left in electronic equipment and on circuit boards without any declaration or restriction and collected by an authorized disposal and recycling agency for electronic waste.

Customers outside Germany are requested to observe the disposal regulations which apply in their respective country.

15 Structure of the ordering code (part number)

All technical products produced by our company are identified by a part number (which is identical to the ordering code). This number is a unique identifier for any respective specific component that can be supplied by us. The customer can speed up and facilitate processing of his order by quoting the part number. All components are supplied in accordance with the part numbers ordered.

The structure of the ordering code is explained in the data sheet section ([pages 12 and 18](#)).

Quality Assurance

1 General

The high demands made of us by the world market for product and service quality make a comprehensive, thorough and up-to-date quality management system indispensable.

The QM system introduced in Capacitors Division was certified to EN ISO 9001 in June 1992. Numerous customer audits and awards are evidence of its efficiency and effectiveness.

The QM system has been further developed and refined in line with the requirements of standards (EN ISO 9000 ff, CECC) and EFQM criteria. The next objective is certification to QS 9000 and VDA 6.1.

VDE PRÜF- UND ZERTIFIZIERUNGSMANAGEMENTINSTITUT
VDE Verband Deutscher Elektrotechniker e.V.

CERTIFICATE

Registration-Number: 404.6/QM/10.93 (AA)

This is to certify that the company

Siemens Matsushita Components GmbH & Co. KG

in the following location

Siemensstraße 81, D-89520 Heidenheim

has implemented and maintains a
Quality-Management System for the following scope:

Division Capacitors

This QM-System complies with the requirements of:

DIN EN ISO 9001:1994
Quality systems
Model for quality assurance in design/development,
production, installation and servicing

This certificate is valid until 1999-11-04

VDE Testing and Certification Institute
Department for Certification



D-63069 Offenbach/Main, Merianstraße 28
Date: 1996-11-05



The VDE Testing and Certification Institute is accredited by DAR according to EN 45012:
and notified in the EU under ID. No. 0366.



Deutscher
Akkreditierungs-
Rat
DAR
TGA-ZG-009/92-00

HARMONIZED SYSTEM OF QUALITY ASSESSMENT FOR ELECTRONIC COMPONENTS CECC		ECQAC
CERTIFICATE OF APPROVAL OF MANUFACTURER CECC 00 114 PART I/EN 100 114 PART I		
REGISTRATION NUMBER:	404.6/06.90 (AA)	
MANUFACTURER:	Siemens Matsushita Components GmbH & Co. KG	
AT THEIR PLACE OF WORK:	Siemensstraße 81, DD-89520 Heidenheim	
IN RESPECT OF GENERIC/ SECTIONAL SPECIFICATION:	CECC 30 200/EN 130 200 Fixed Tantalum Capacitors with non-solid or solid Electrolyte CECC 30 800 Tantalum Surface Mounting Capacitors	
<p>THE ORGANIZATION, FACILITIES AND INSPECTION PROCEDURES AT THE ABOVE PLACE OF WORK HAVE BEEN FOUND TO COMPLY WITH THE REQUIREMENTS OF DOCUMENT CENELEC MEMORANDUM 18 AND IN PARTICULAR OF DOCUMENT DIN EN 100 114 PART I AND DIN EN ISO 9001:1994 FOR QUALITY ASSESSMENT IN RESPECT OF THE FAMILIES OF COMPONENTS LISTED IN THE APPROVAL DOCUMENT(S).</p> <p>THIS CERTIFICATE DOES NOT AUTOMATICALLY ENTITLE THE MANUFACTURER TO USE THE MARK OR CERTIFICATE OF CONFORMITY. THE APPROVAL OF ANY PARTICULAR TYPE OF ELECTRONIC COMPONENT IS THE SUBJECT OF A SEPARATE CERTIFICATE.</p>		
THIS APPROVAL CERTIFICATE ALSO COVERS ALL REQUIREMENTS OF DIN EN ISO 9001:1994		
CECC CENELEC Electronic Components Committee ECQAC Electronic Components Quality Assurance Committee	<p>NOTE: This certificate is valid only in conjunction with the approval document(s).</p> <p>This approval may be suspended or withdrawn in accordance with CENELEC Memorandum 18.</p> <p>This certificate remains the property of the body which granted it. This approval is valid until 1999-11-04</p>	<p>VDE ASSOCIATION OF GERMAN ELECTRICAL ENGINEERS VDE TESTING AND CERTIFICATION INSTITUTE AS THE NATIONAL SUPERVISING INSPECTORATE</p> <p>D-63069 OFFENBACH DATE: 1996-11-05</p> 

1.1 Total quality management and zero defect concept

The strategic aim of Total Quality Management (TQM) is to satisfy the demands made by customers on products or services in terms of function, quality, punctuality and price/performance.

Based on the principle "quality from the very start", all instances and persons at S+M Components are involved in implementing this aim. Systematic planning, careful selection of suppliers and sure mastery of design and manufacturing processes are the major guarantees of a constantly high quality standard.

Internal quality promotion measures, such as training, quality groups, quality assurance circles and Q audits strengthen the feeling of responsibility in all employees, helping them to realize the significance of defects and thus avoid them.

Modern quality tools such as FMEA, SPC and Zero-Defect Programs with CEDAC¹⁾ diagrams supplement and support measures for quality assurance and enhancement.

1) FMEA
SPC
CEDAC

Failure Mode and Effects Analyses
Statistical Process Control
Cause and Effect Diagram with Addition of Cards

1.2 Quality assurance system

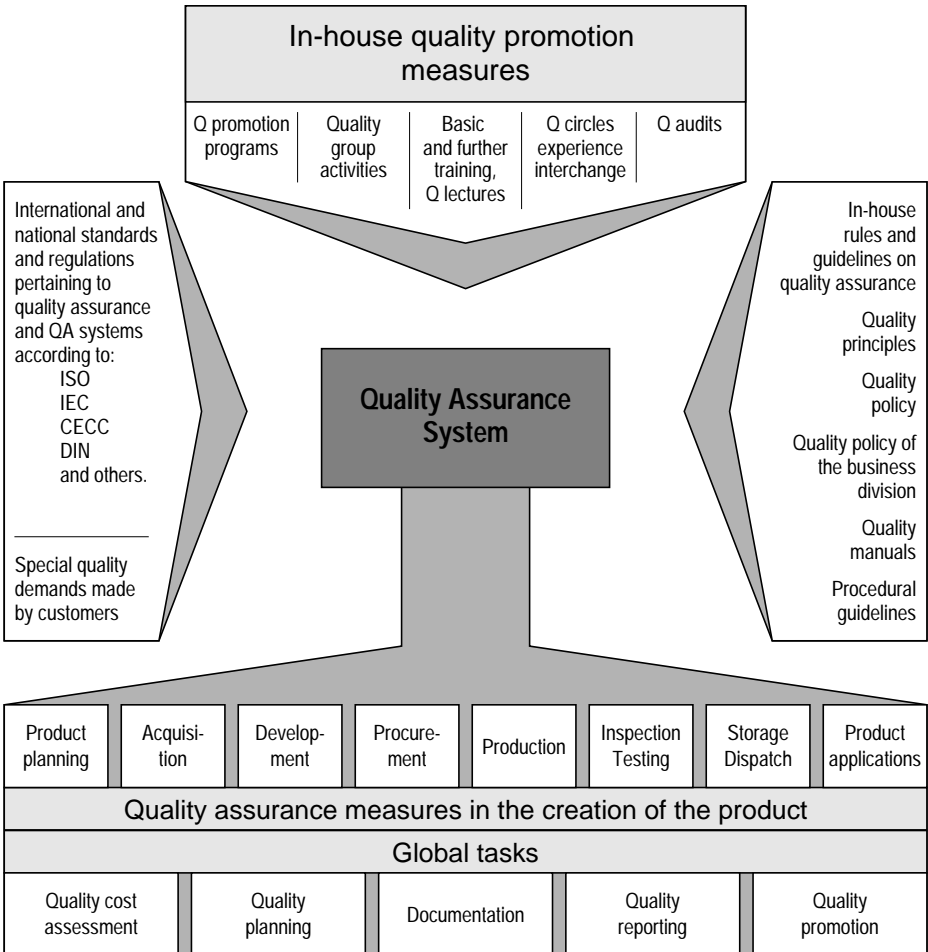

2 Quality assurance procedure

The quality department examines capacitors and releases them for production according to the following criteria:

- compliance with type specifications
- process capability of equipment
- measuring and test technique.

The entire production process – from procurement of parts and materials, through the fabrication process to final inspection – is accompanied by quality assurance measures. The flow chart (cf. 2.5) shows the quality inspections stipulated for each individual step.

2.1 Material procurement

The high quality of parts and materials required in the manufacture of high-grade products is achieved through close co-operation with suppliers. Focal aspects of these quality assurance measures are the choice and qualification of suppliers, harmonization of specifications, incoming-goods inspection, quality assessment and problem management.

2.2 Product quality assurance

All essential manufacturing processes are subjected to permanent monitoring. Critical parameters, in particular, are subjected to statistical process control (SPC).

So-called “QC gates” are planned into the manufacturing process, i.e. there is an inspection for release at the end of the corresponding step. The continuous monitoring and evaluation of the test results are used to assess procedures and to determine how well the processes are mastered.

2.3 Final inspection

The capacitors are subjected to a specification-based final inspection. The parameters capacitance tolerance, dissipation factor / equivalent series resistance, impedance, leakage current and properties (i.e. mechanical finish) are checked.

2.4 Product monitoring

Our quality assurance department periodically carries out tests on random samples taken from current production lots to check climatic resistance, operational reliability, solderability and resistance to soldering heat in accordance with DIN, CECC and IEC specifications.

2.5 Manufacturing and quality assurance procedures for chip capacitors

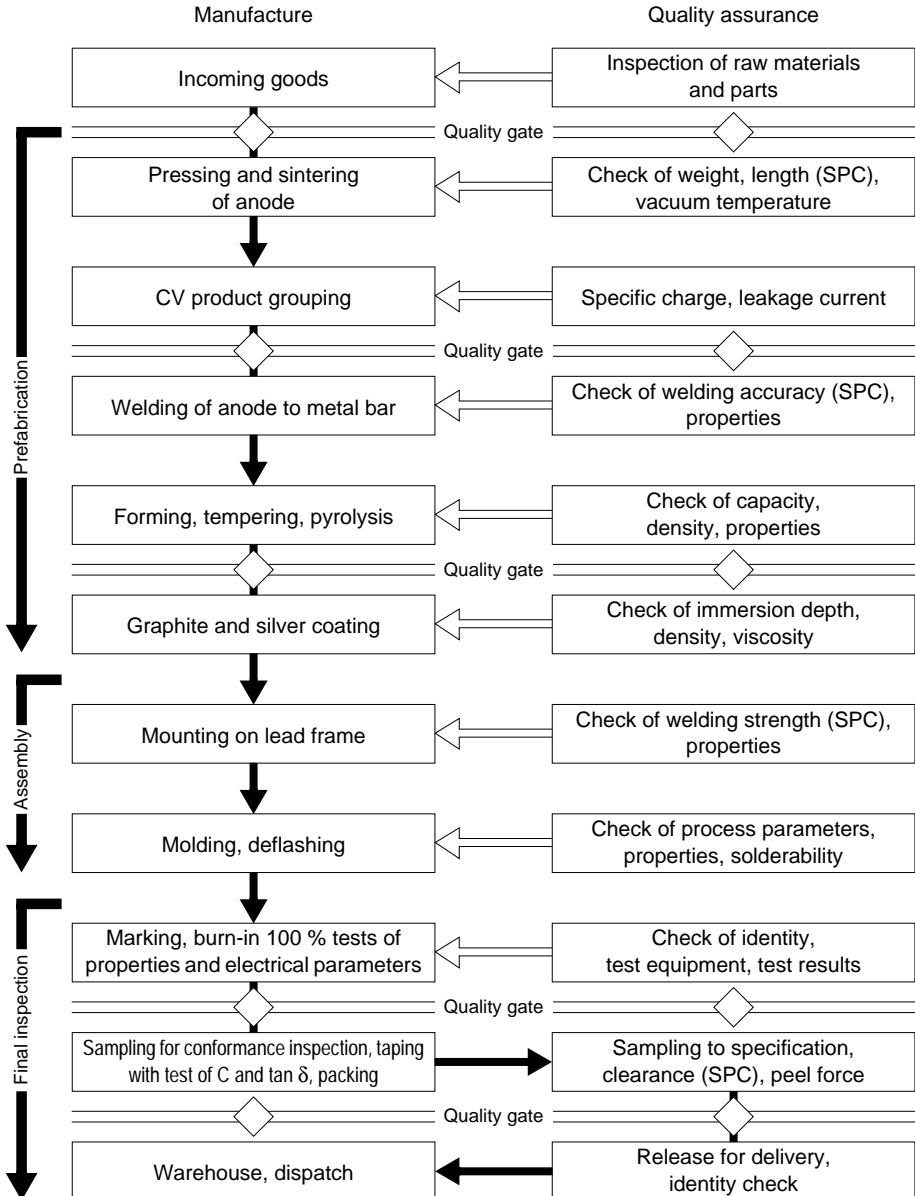

Quality Assurance

3 Delivery quality

The term “delivery quality” is used to indicate conformance with the mutually agreed specifications at the time of delivery.

This conformance is monitored and guaranteed by quality assurance through constant sampling tests. Their accumulated results produce the AOQ (average outgoing quality) figures.

3.1 Random sampling

The AQL (AQL = acceptable quality level) figures given in [section 3.3](#) are based on random sample inspection specification ISO 2859-1 single sampling plan for normal inspection, inspection level II. The contents of this standard correspond to MIL STD105 D and IEC 410.

The sampling instructions of this standard are such that a delivered lot will be accepted with a probability of $\geq 90\%$ if the percentage of non-conformancies does not exceed the stated AQL figure.

As a rule, the percentage of non-conformancies in deliveries from S+M Components is significantly below the AQL figure. The acceptance figure we apply to inoperatives, i.e. unusable components is $c=0$.

3.2 Classification of inoperatives / non-conformancies

A non-conformancy exists if a component characteristic fails to meet the data sheet specifications or an agreed delivery specification. Inoperatives are totally unusable components.

Inoperatives:

- short circuit or open circuit
- breakage of terminals or encapsulation
- wrong or missing marking
- wrong marking of terminals
- mixing with other components
- alternating orientation in one tape

Non-conformancies:

- non-conformancies in electrical characteristics
(electrical characteristics outside of specified limits)
- non-conformancies in mechanical properties
(e.g. wrong dimensions, damaged case, illegible marking, bent terminals).

3.3 AQL figures

The following AQL figures apply to the non-conformancies listed above:

- inoperatives (electrical and mechanical) 0,065
- sum of electrical non-conformancies 0,25
- sum of mechanical non-conformancies 0,25

3.4 Incoming goods inspection

We recommend the use of a random sampling plan according to ISO 2859-1 (the contents correspond to MIL STD 105 D and IEC 410) for incoming goods inspection.

The test methods to be used are laid down in the relevant standards. Deviations must be agreed by the customer and the supplier. In case of complaints refer to [section 7](#).

Single sampling plan for normal inspection – inspection level II

Excerpt from ISO 2859-1:

Sampling plan N = Lot size	AQL 0,065	AQL 0,10	AQL 0,15	AQL 0,25
	2 ... 50	N-0	N-0	N-0
51 ... 90	N-0	N-0	N or 80-0	50-0
91 ... 150	N-0	N or 125-0	80-0	50-0
151 ... 280	N or 200-0	125-0	80-0	50-0
281 ... 500	200-0	125-0	80-0	50-0
501 ... 1 200	200-0	125-0	80-0	50-0
1 201 ... 3 200	200-0	125-0	80-0	200-1
3 201 ... 10 000	200-0	125-0	315-1	200-1
10 001 ... 35 000	200-0	500-1	315-1	315-2

Columns 2 to 5:

Left-hand figure = sample size

Right-hand figure = acceptable inoperatives/non-conformancies

Classification of

inoperatives/non-conformancies: [cf. paragraph 3.2](#)

Constant improvement of our performance is a primary objective, especially optimization of product quality in close cooperation between producer and user. For this purpose we offer our customers the possibility of quality assurance agreements.

4 Service life

The service life is defined as the time that passes before a given failure percentage is attained for the respective component. The failure percentage is the ratio of the number of failures to the total number of inspected capacitors of the respective type. The service life depends on the defect criteria applied and on the operating conditions, i.e. on the electrical and thermal stress to which the capacitor is subjected.

The service life values stated in this data book have been established by carrying out endurance tests and accelerated tests (e.g. increased temperature). They refer to an ambient temperature of 40 °C, rated voltage and a circuit resistance of $\geq 3 \Omega/V$.

The service life increases:

- with decreasing ambient temperatures,
- with decreasing superimposed ac voltage,
- with decreasing operating voltage/rated voltage ratios
- with increasing circuit resistance ([cf. paragraphs 5.3, 5.4](#))
- with decreasing operating temperature ([cf. paragraph 5.3](#) and [figure 2](#))

4.1 Failure criteria

Inoperatives: short-circuit or open circuit

Failure due to variation, i.e. unsatisfactory electrical characteristics:

- I > $5 \cdot I_{lk} + 5 \mu\text{A}$
 - Z > 3 times the initial limit value
 - $\tan \delta$ > 1,5 times the initial limit value
 - ΔC for $V \leq 16 \text{ V}$: + 10 ... - 20 %
 - for $V > 16 \text{ V}$: + 10 ... - 10 %
- } beyond (initial) tolerances

5 Reliability

Data on long-term reliability under severe or moderate operating conditions are gained from endurance tests which are carried out continuously. The data are based on the failures registered for capacitors under a defined load, and long-term reliability of the individual types tested is based on a confidence level of 60%. Our reliability data result from very large numbers of component operating hours.

5.1 Failure rate (long-term failure rate)

The failure rate is defined as the failure percentage divided by a specified operating period. The failure rate is expressed in fit (failures in 10^9 component hours) or as percentage of failures in 1000 hours.

1 fit = $1 \cdot 10^{-9}/\text{h}$ (fit = failure in time)

Example of a failure rate λ_{test} determined by a useful life test:

- | | |
|--------------------------------|---------------------------|
| 1) Number of components tested | $N = 8\,000$ |
| 2) Operating hours | $t_b = 25\,000 \text{ h}$ |
| 3) Number of failures | $n = 2$ |

$$\lambda_{\text{test}} = \frac{n}{N} \cdot \frac{1}{t_b} = \frac{2}{8000} \cdot \frac{1}{25000\text{h}} = 10 \text{ fit} = 0,001 \text{ \%}/1000 \text{ h.}$$

Failure rate specifications must include failure criteria, operating conditions and ambient conditions.

Usually the failure rate of components, when plotted against time, shows a characteristic curve with the following two periods:

I : early failure period, II: service period

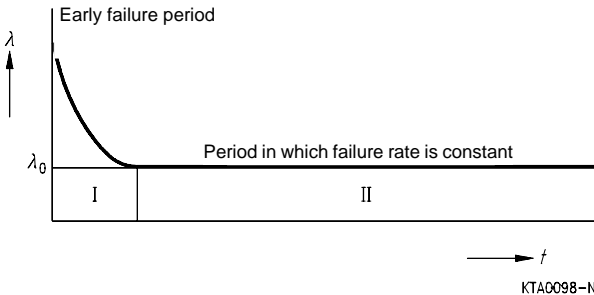

Fig. 1 Failure rate periods

Due to the 100 % burn-in tests, the early failure period (phase I) will coincide with the manufacturing process. Because of this, the failure rate relates to the service period (phase II). In phase II, an almost constant failure rate λ_0 can be expected, with a slight tendency to decrease with time.

5.2 Failure rate values

The failure rate (specified on page 19) refers to the following conditions.

Electrical load:

Operation at rated voltage
Circuit resistance $\geq 3 \Omega/V$

Climatic conditions:

Ambient temperature 40 °C, climatic class 3K3 in accordance with IEC 721,
non-corrosive atmosphere

Mechanical stress:

Class 3M3 in accordance with IEC 721

Service period:

Phase II as shown in figure 1.

Quality Assurance

These reference conditions do not always correspond to actual application conditions. For real applications, the failure rate must therefore be calculated as follows:

$$\lambda = \lambda_{\text{ref}} \cdot \pi_V \cdot \pi_T \cdot \pi_{R_S}$$

λ_{ref}	Failure rate under reference conditions
π_V	Factor for voltage dependence
π_T	Factor for temperature dependence
π_{R_S}	Factor for dependence on circuit resistance

5.3 Failure rate conversion factors

The failure percentage and failure rate are affected by the ambient temperature, the V_{op}/V_R ratio, and, for capacitors with solid electrolyte, by the circuit resistance. These values increase with increasing ambient temperatures, and they are decreased by lowering the V_{op}/V_R ratio and increasing the circuit resistance.

Conversion factors for taking into account the effects of ambient temperature and operating voltage on the failure rate within the service life can be deduced from the table below or from the graph in [figure 2](#) (guideline values).

V_{op}/V_R	0,2	0,4	0,5	0,6	0,8	1
π_V	$3,5 \cdot 10^{-4}$	$2,4 \cdot 10^{-3}$	$6,5 \cdot 10^{-3}$	$1,7 \cdot 10^{-2}$	0,13	1
$T/^\circ\text{C}$	20	40	60	85	105	125
π_T	0,5	1	2,2	10	49	250
Circuit resistance	Ω/V	≥ 3	1	0,3	$\leq 0,1$	
π_{R_S}	$C_R \cdot V_R/\mu\text{C}$	≤ 330	1	2	3,5	5
		> 330	1	2,8	6,1	12

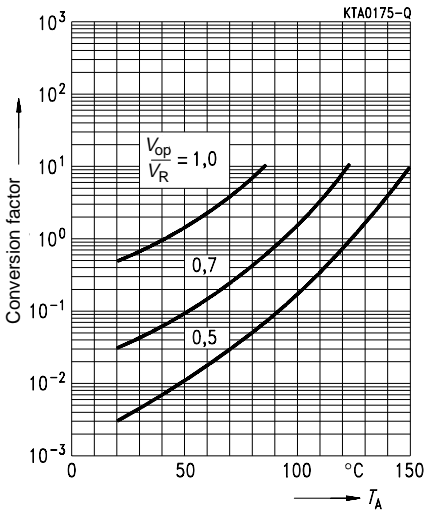

Fig. 2 Conversion factors for the failure rate

5.4 Effect of the circuit resistance (series resistance) on the failure rate of tantalum electrolytic capacitors with solid electrolytes

The employment of a certain series resistance is not a necessary condition for problem-free use of tantalum capacitors with solid electrolyte. However, it is possible to influence the service life by the series resistance value.

The failure rates specified in this book are based on circuits containing a series resistance (circuit resistance). In addition to the temperature and applied voltage, the series resistance too has an effect on the failure rate. The circuit resistance is defined as the total resistance as seen from the capacitor in the direction of the voltage source. It is the sum of the internal resistance of the voltage source, the wiring resistance and any additional resistors connected in series.

The circuit resistance is only of importance when there are localized dielectric breakdowns in the capacitor due to overloads. In such cases the circuit resistance limits the current and permits a self-healing of the capacitor. Tantalum capacitors with solid electrolyte have the ability to regenerate and heal internal defects.

The self-healing effect can only be successful if the breakdown occurs in a small area and if the energy dissipation in that area is limited while regeneration is taking place. If these conditions are not given, localized overheating may occur, leading to an expansion of the defect area and thus rendering regeneration impossible. While this self-healing process is taking place, the circuit resistance keeps the energy supply to a tolerable level, since the highly conductive solid electrolyte can take over this function only to a certain extent.

Thus the circuit resistance has a decisive effect on the self-healing process and, as a result, on the failure rate. The respective CECC standards contain corresponding information and data.

Quality Assurance

A current limit of approximately 300 mA (for limiting the energy dissipation) has been found to be suitable for enabling an effective self-healing process. This corresponds to a circuit resistance of $3 \Omega/V$. If the circuit resistance is lower, thus impairing the conditions for self-healing in the case of localized dielectric breakdown, then the failure rate increases, as expressed by the larger factors. In extreme cases, i.e. where the resistance approaches zero ($\leq 0,1 \Omega/V$), the failure rate may increase to factor of approximately ten, depending on the case size.

5.5 Example of how to calculate the failure rate

Given:	ambient temperature	T_A	= 60 °C
	operating voltage	V_{op}	= 25 Vdc
	circuit resistance	R_S	$\leq 0,1 \Omega/V$
capacitor used (e. g. B 45 196-E):		C_R	= 1 μF
		V_R	= 50 Vdc
		failure rate	= ≤ 3 fit under reference conditions.

For $\frac{V_{op}}{V_R} = 0,5$ and $T_A = 60$ °C, a conversion factor of approximately 0,015 is deduced from [figure 2 on page 71](#). The same value is obtained from the table [on page 70](#) by multiplying $\pi_V \cdot \pi_T$.

For a circuit resistance of $\leq 0,1 \Omega/V$ and $C_R \cdot V_R/\mu C \leq 330$ the table gives a conversion factor of 5. Calculated failure rate: $\lambda = 3 \cdot 10^{-9}$ failures/h $\cdot 0,015 \cdot 5 = 0,23 \cdot 10^{-9}$ failures/h = 0,23 fit.

5.6 Failure rate for B 45 194

As already explained, the failure rate varies with the operating conditions (ambient temperature, applied voltage, circuit resistance, application circuits etc.). Select the capacitors to obtain an adequate safety margin by fully examining the operating conditions.

The failure rate of B 45194 capacitors is given as percentage in 1000 hours and refers to rated voltage applied at 85 °C. Check the design objective with the following formula for the failure rate:

$$\lambda_{op} = \lambda_{850C} \cdot K_t \cdot K_{sr}$$

λ_{op} Predicted failure rate at operating conditions

λ_{850C} Failure rate level at rated voltage and 85 °C:
1%/1000 h

K_t Multiplying factor of failure rate as a function of maximum temperature and $\frac{V_{op}}{V_R}$,
see [figure 3](#)

K_{sr} Multiplying factor of failure rate as a function of circuit resistance (Ω/V), see [figure 4](#)

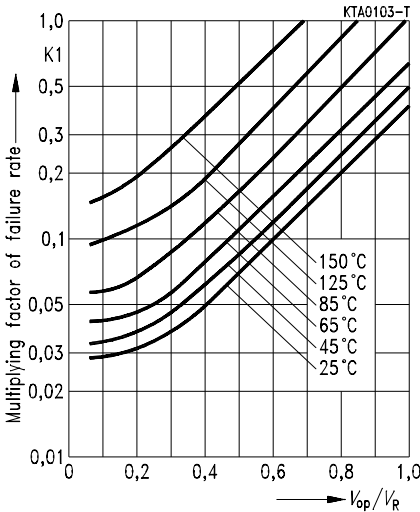

Fig. 3 Multiplying factor of failure rate versus temperature and voltage

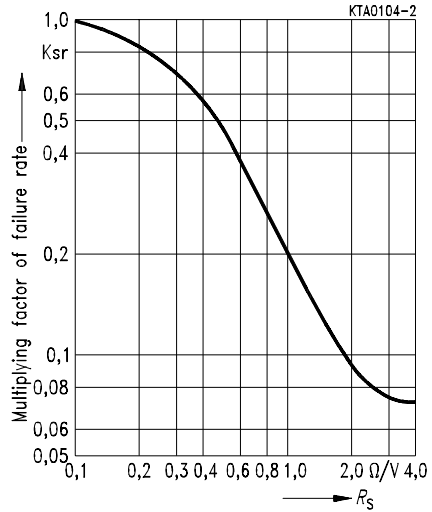

Fig. 4 Multiplying factor of failure rate versus circuit resistance

Always consider safety when designing equipment and circuits. Plan for worst case failure modes such as short circuits and open circuits which could occur during use.

- Provide protection circuits and protection devices to allow safe failure modes.
- Design redundant and secondary circuits where possible to assure continued operation in case of main circuit failure.

6 Supplementary information

The specification of quality data – which always refer to a fairly large number of components – does not constitute a guarantee of characteristics or properties in the legal sense. However, agreement on these specifications does not mean that the customer may not claim for replacement of individual defective capacitors within the terms of delivery. S + M Components cannot, however, assume any further liability beyond the replacement of defective components. This applies in particular to any further consequences of component failure.

Furthermore, it must be taken into consideration that the figures stated for service life and failure rate refer to the average production status and are therefore to be understood as mean values (statistical expectations) for a large number of delivery lots of identical capacitors. These figures are based on application experience and on data obtained from preceding tests under normal conditions, or – for purposes of accelerated aging – more severe conditions.

7 Handling of claims and complaints

A main aim of our quality assurance system is to prevent any faults occurring. The following details will help us to respond quickly to any complaints which you may need to make:

- a) Non-conformancies (inoperatives) in incoming goods
 - Description of non-conformancy
 - Test method / circuit
 - Sample size
 - Number of non-conforming units found
 - Proof unit
 - Packing slip
- b) Non-conformancies (inoperatives) in production or operation
 - Description of non-conformancy
 - When and how was the non-conformancy detected
 - Operating conditions
 - Length of operation before non-conformancy occurred
 - Details as under a) if possible and applicable.

If transport damage has occurred, please describe it in detail and, if possible, mark it so that it can be distinguished from any other damage that may occur when the articles are returned. The original packing should also be examined and damage discovered should be described. To avoid further damage, please use the original packing, wherever possible, to return the articles being claimed for.

Measuring and Test Conditions

1 Test conditions selected from IEC 60-384-1

Endurance 2000 h at +85 °C or 2000 h at +125 °C at reduced voltage	$I\Delta C/C$ $\tan \delta$ $I_{k20^\circ C}$	$\leq 10\%$ of initial value \leq limit value (in part 1,5 · limit value) $\leq 1,25 \cdot$ initial limit value (in part 2 · limit value)
Storage at high temperature without voltage applied 5000 h at +85 °C	$I\Delta C/C$ $\tan \delta$ $I_{k20^\circ C}$	$\leq 10\%$ of initial value $\leq 1,5 \cdot$ limit value \leq limit value
Damp heat, steady state ^{*)} in accordance with IEC 68-2-3 ^{*)} Increased test severity for chip capacitors B 45 196-P, see below	Severity 4: Duration: $I\Delta C/C$ $\tan \delta$ $I_{k20^\circ C}$	40 (± 2) °C; 93 (+2/-3) % relative humidity; 56 days $\leq 5\%$ of initial value $\leq 1,2 \cdot$ limit value \leq initial limit value
Vibration Test Fc in accordance with IEC 68-2-6	Frequency range: Amplitude: Test duration: 6 h	10 ... 2000 Hz 1,5 mm (max. 196 m/s ² i.e. 20 g)
Shock Test Ea in accordance with IEC 68-2-27	Peak load :	981 m/s ² i.e. 100 g

2 Tests with more stringent conditions than specified by CECC and IECQ for B 45 196-P

Damp heat, steady state	85 (+2) °C, 85 ... 90 % relative humidity, 1000 h, at rated voltage	
Parameter changes:	$I\Delta C/C$ $\tan \delta$ $I_{k20^\circ C}$	$\leq 10\%$ of initial value $\leq 2 \cdot$ initial limit value $\leq 10 \cdot$ initial limit value
Rapid change of temperature	100 cycles, -55 °C/+125 °C/30 min	
	$I\Delta C/C$ $\tan \delta$ $I_{k20^\circ C}$	$\leq 3\%$ of initial value \leq initial limit value \leq initial limit value

! Measuring and test conditions only apply to B 45 194 if explicitly stated.
 Please contact your nearest Siemens Office for Passive Components if you need further information.

Soldering Conditions

1 Tests

Wetting in accordance with IEC 68-2-58 Preconditioning: Immersion in F-SW 31 flux Assessment criterion: Wetting of terminals $\geq 95\%$ (except for cutting and bending edges)	Solder	Bath temperature	Immersion time
	SnPb 60/40	235 (± 5) °C	2 ($\pm 0,2$) s
	SnPb 60/40	215 (± 3) °C	3 ($\pm 0,3$) s
Resistance to soldering heat in accordance with IEC 68-2-58 Preconditioning: Immersion in F-SW 32 flux Assessment criterion	Solder	Bath temperature	Immersion time
	SnPb 60/40	260 (± 5) °C	10 ($\pm 0,5$) s
	$I\Delta C/C$ $\leq 3\%$ of initial value $\tan \delta$ \leq initial limit value $I_{k20^\circ C}$ \leq initial limit value		
Resistance to soldering heat of B 45 194	Solder	Bath temperature	Immersion time
	SnPb 60/40	260 (± 5) °C	5 (± 1) s

2 Recommended solder pad layouts

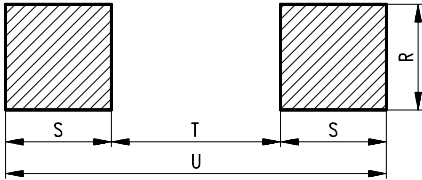

KTA0177-7

Case size	Soldering process	Dimensions (mm)			
		R	S	T	U
Z	Wave soldering	1,2	1,1	1,0	3,2
	Reflow soldering	1,2	0,8	1,0	2,6
P	Wave soldering	1,6	2,6	1,3	6,5
	Reflow soldering	1,6	1,5	1,3	4,3
A	Wave soldering	1,6	1,9	1,2	5,0
	Reflow soldering	1,5	1,5	0,8	3,8
B	Wave soldering	2,7	2,0	1,5	5,5
	Reflow soldering	2,5	1,5	1,1	4,1
C	Wave soldering	2,7	2,8	3,0	8,6
	Reflow soldering	2,5	2,0	2,6	6,6
D	Wave soldering	2,9	2,9	4,4	10,2
	Reflow soldering	2,7	2,0	3,9	7,9
E	Wave soldering	2,9	2,9	4,4	10,2
	Reflow soldering	2,7	2,0	3,9	7,9

Soldering Conditions

3 Recommended soldering temperature profiles for chip capacitors (in accordance with CECC 00802 Edition 2)

Vapor phase soldering

Chamber (batch) process with preheating. Temperature at component terminal applies

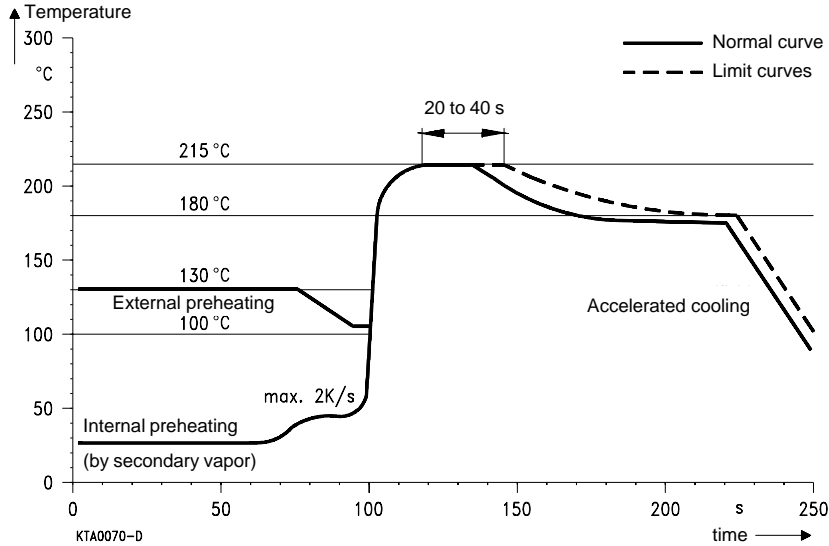

Conveyor (continuous) process with preheating. Temperature at component terminal applies

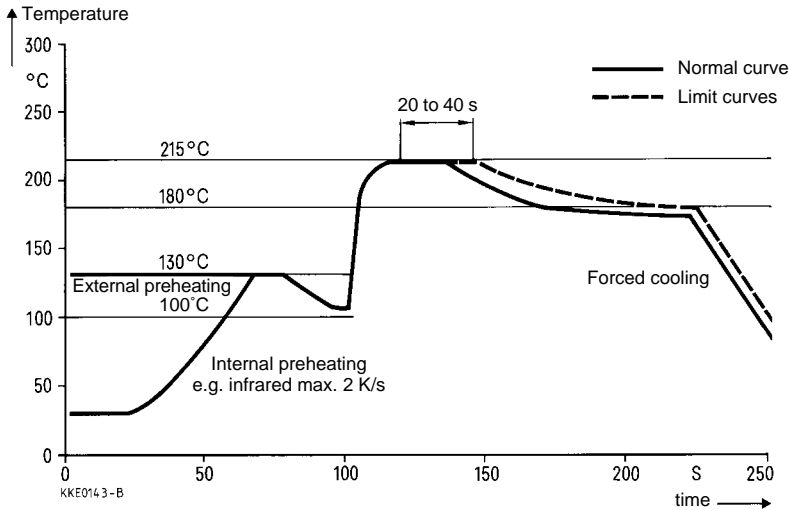

Wave soldering

Temperature curve at component terminal during dual wave soldering

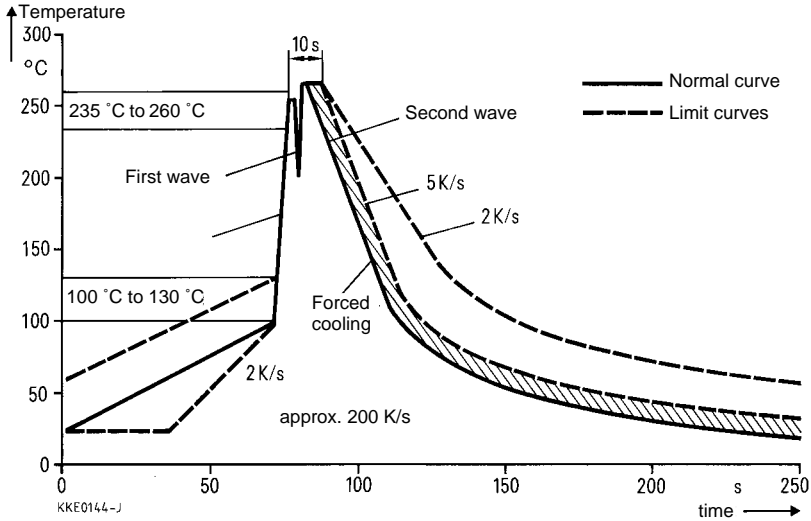

Infrared reflow soldering

Temperature curve at component terminal in infrared soldering

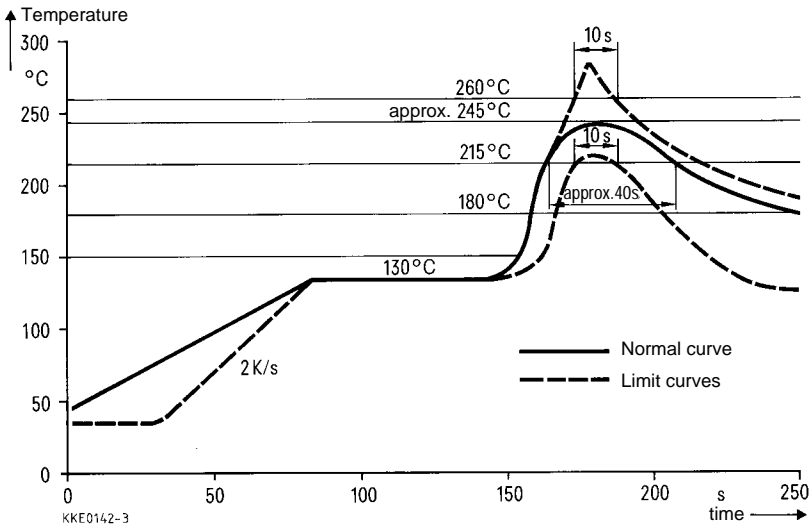

Soldering Conditions

4 Recommended soldering temperature profiles for B 45 194

Wave soldering

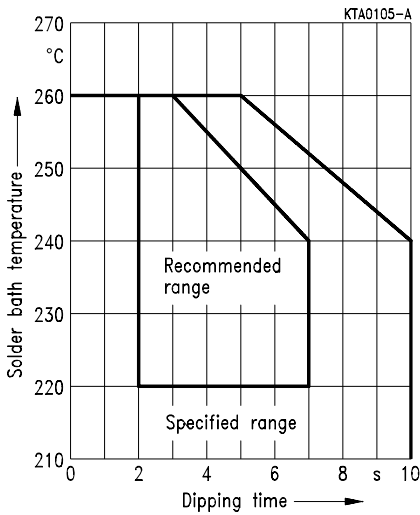

The components are fixed to the board with adhesive, and are directly dipped into the solder bath.

- When component mounting density is high, solderability may be decreased.
Take notice to drain gas.
- Preheat for 2 minutes at 160 °C.
Cool after soldering

Reflow soldering

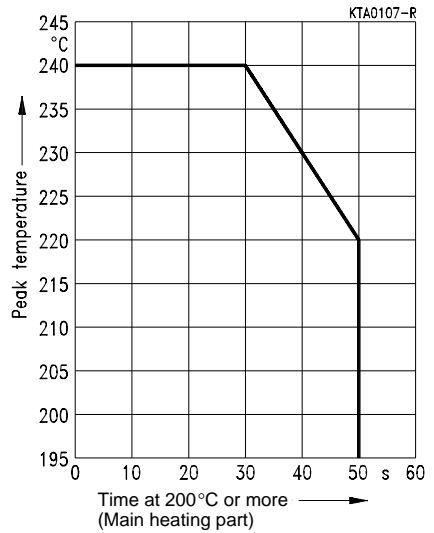
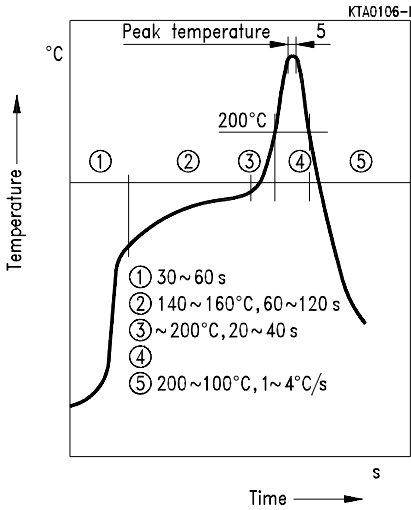

- ① Temperature rising part I
Ordinary temperature to preheating part
- ② Preheating part
- ③ Temperature rising part II
Preheating part to 200 °C
- ④ Main heating part
Refer to figure on next page
- ⑤ Cooling part
200 to 100 °C

The components and the board are heated by an hot blast oven or an infrared radiation oven.

- Measure temperature at the component surface.
- Do not perform reflow more than twice.

Please consult supplier for vapor phase soldering conditions.



Siemens Matsushita Components

Applications with a future

We set your ideas in motion

When it comes to implementing ideas, you couldn't choose a better partner. Our flexibility turns standard products into new ones with all the right features. Whether capacitors and converter filters for wind-driven power plants, ferrite antennas for radio wrist-watches or SAW filters for the new wide-screen TV generation. If you've got the application, we've got the component.



SCS – dependable, fast and competent



Taping, Packing and Weights

1 Taping

Chip capacitors are taped and reeled in accordance with IEC 286-3. Sizes Z, P, A and B are supplied in 8-mm blister tapes, sizes C, D and E in 12-mm blister tapes. The tapes and reels are anti-static. The position of the positive pole is shown in the outline drawing below.

Tape dimensions and tolerances

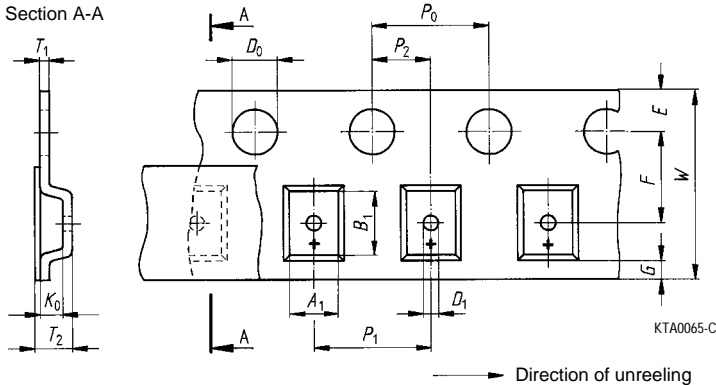

Dimensions (mm)	Case size						
	Z	P	A	B	C	D	E
$A_1 \pm 0,2$	1,35	1,9	1,9	3,3	3,7	4,7	4,7
$B_1 \pm 0,2$	2,2	3,5	3,5	3,8	6,5	7,7	7,7
$D_0 + 0,1/-0$	1,5	1,5	1,5	1,5	1,5	1,5	1,5
D_1 min.	1,0	1,0	1,0	1,0	1,5	1,5	1,5
$P_0 \pm 0,1^{1)}$	4,0	4,0	4,0	4,0	4,0	4,0	4,0
$P_1 \pm 0,1$	4,0	4,0	4,0	4,0	8,0	8,0	8,0
$P_2 \pm 0,05$	2,0	2,0	2,0	2,0	2,0	2,0	2,0
$W \pm 0,3$	8,0	8,0	8,0	8,0	12,0	12,0	12,0
$E \pm 0,1$	1,75	1,75	1,75	1,75	1,75	1,75	1,75
$F \pm 0,05$	3,5	3,5	3,5	3,5	5,5	5,5	5,5
G min.	0,75	0,75	0,75	0,75	0,75	0,75	0,75
$T_1 \pm 0,05$	0,25	0,25	0,25	0,25	0,3	0,3	0,3
T_2 max.	1,9	1,9	2,3	2,6	3,3	3,6	4,8
$K_0 \pm 0,1$	1,5	1,5	1,9	2,2	3,0	3,3	4,5

1) 0,2 mm over 10 sprocket hole spaces

Taping, Packing and Weights

2 Packing

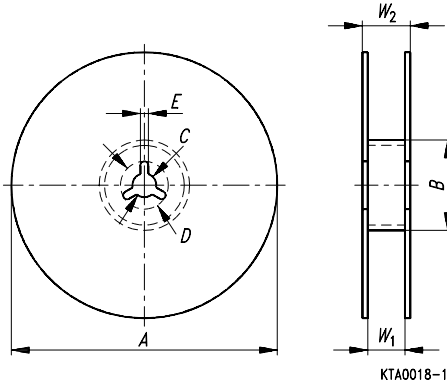

Dimensions (mm)	Reel	
	180 mm diameter	330 mm diameter
A	180 ± 0,5	330 ± 0,5
B	62,5 – 2,5	62,0 ± 1,5
C	13,0 ± 0,5	12,75 + 0,15/-0
D	22,0 ± 1,0	21,0 ± 0,5
E	2,0 ± 0,5	2,0 + 0,5/-0
W ₁ (8-mm tape) (12-mm tape)		8,4 + 0,2/-0 12,4 + 0,2/-0
W ₂ (8-mm tape) (12-mm tape)	11,0 ± 0,1 15,0 ± 0,1	8,4 + 0,2/-0 12,4 + 0,2/-0

3 Packing units and weights

Case size	Taped; pieces/reel		Approx. weight per capacitor g ¹⁾
	180 mm diameter	330 mm diameter	
Z	3000	—	0,008
P	3000	—	0,02
A	2000	9000	0,06
B	2000	8000	0,09
C	750	3000	0,20
D	750	2800	0,35
E	400	1800	0,50

1) Guideline values, possible deviations of up to approximately ± 30 %



Siemens Matsushita Components

Now twice as many

2,000 PTC thermistors at once

A hot tip in PTCs for overload protection: our new maximum order level of 2,000 pieces. And with more than 50 different models, we've got a lot more to offer too. Maximum operating voltages from 12 to 550 V, rated currents up to 2.5 A, maximum switching currents of 15 A, plus a broad selection of leaded versions and SMDs.



SCS – dependable, fast and competent

Subject Index

A

ac power dissipation	52
anode	43
AQL figures	66

B

back-to-back circuit	47
basic construction	43

C

capacitance	48
frequency dependence	49
temperature dependence	48
capacitance tolerance	48
category temperature	57
cathode	43
CEDAC diagram	62
charge-discharge proof	49
circuit resistance	71
claims and complaints	74
cleaning agents	58

D

damp heat	75
damp heat conditions	57
delivery quality	66
dielectric	43
disposal of old capacitors	60
dissipation factor	54

E

EN ISO 9001	61
end of use	60
endurance	75
equivalent circuit diagram	50
equivalent series resistance	50

F

failure criteria	68
failure percentage	67
failure rate	68
calculation examples	72
conversion factors	70
values	69

final inspection	64
fit	68
FMEA	62

I

IEC climatic category	58
impedance	50
incoming goods inspection	66
incorrect polarity	47
inherent voltage	47
inoperatives	66
ISO 9000	61

L

leakage current	55
after storage	57
measurement of ...	56
temperature dependence	55
time dependence	56
voltage dependence	55

M

material procurement	64
maximum continuous voltage	45
maximum ripple current	52
mounting	58

N

non-conformancies	66
-------------------	----

O

operating voltage	46
ordering code	60

P

packing	59, 84
packing units	84
part number	60
polarity	44
polarity reversal voltage	47
power dissipation	53
product monitoring	64
product quality assurance	64

Q

quality assurance	61
quality assurance procedure	64
quality assurance procedures	
chip capacitors	65
quality assurance system	63
quality data	73

R

random sampling	66
rated capacitance	48
rated voltage	45
recharging	47
reliability	68
resistance to climatic stress	57

S

series back-to-back connection	47
series resistance	71
service life	67
shock	75
solder pad layouts	77
soldering tests	76
SPC	62
standard barcode label	58
standards	44
statistical process control	64
storage and transportation temperatures	58
storage test	75
superimposed alternating voltage	52
surge voltage	46

T

taping	83
temperature coefficient, positive	48
temperature range	57
tolerance at delivery	48
total quality management	62
transient voltages	46

V

vibration	75
voltages	45

W

weights	84
---------	----

Z

zero defects concept	62
----------------------	----

Symbols and Terms

Symbol	English	German
C	Capacitance	Kapazität
C_R	Rated capacitance	Nennkapazität
ΔC	Capacitance change	Kapazitätsänderung
$\Delta C/\Delta C_R$	Capacitance tolerance	Kapazitätstoleranz
C_S	Series capacitance	Serienkapazität
C_f	Capacitance at frequency f	Kapazität bei Frequenz f
ESL	Self-inductance	Eigeninduktivität
ESR	Equivalent series resistance	Ersatz-Serienwiderstand
ESR_T	Equivalent series resistance at temperature T	Ersatz-Serienwiderstand bei Temperatur T
f	Frequency	Frequenz
I	Current	Strom
I_{ac}	Alternating current	Wechselstrom
I_f	Alternating current at frequency f	Wechselstrom bei Frequenz f
I_{lk}	Leakage current	Reststrom
P	Power dissipation	Verlustleistung
R_S	Series resistance (circuit resistance)	Serienwiderstand (Schaltkreiswiderstand)
T	Temperature	Temperatur
T_{max}	Upper category temperature	Obere Grenztemperatur (Kategorietemperatur)
T_{min}	Lower category temperature	Untere Grenztemperatur (Kategorietemperatur)
T_A	Ambient temperature	Umgebungstemperatur
t	Time	Zeit
t_{op}	Operating time	Betriebszeit
V	Voltage	Spannung
V_{ac}	AC voltage	Wechselspannung
V_{cont}	Max. continuous voltage	Dauergrenzspannung
V_F	Forming voltage	Formierspannung
V_{op}	Operating voltage	Betriebsspannung
V_R	Rated voltage	Nennspannung
V_{rev}	Reverse voltage	Umpolspannung
V_S	Surge voltage	Spitzenspannung
Z	Impedance	Scheinwiderstand
Z_T	Impedance at temperature T	Scheinwiderstand bei Temperatur T
$\tan \delta$	Dissipation factor	Verlustfaktor
$\tan \delta_T$	Dissipation factor at temperature T	Verlustfaktor bei Temperatur T
$\tan \delta_f$	Dissipation factor at frequency f	Verlustfaktor bei Frequenz f

Symbol	English	German
λ	Failure rate (1 fit = $1 \cdot 10^{-9}$ failures/h)	Ausfallrate (1 fit = $1 \cdot 10^{-9}$ Ausfälle/h)
π_V	Factors for failure rate calculation: Factor for voltage dependence	Faktoren zur Berechnung der Ausfallrate: Faktor für Spannungsabhängigkeit
π_T	Factor for temperature dependence	Faktor für Temperaturabhängigkeit
π_{RS}	Factor for dependence on circuit resistance	Faktor für Abhängigkeit vom Schaltkreiswiderstand
Decimal points are indicated by commas.		