

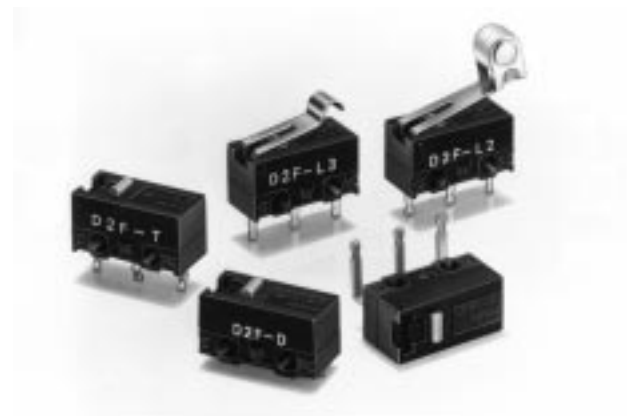



A Variety of D2F-series Models Including Models Incorporating Simulated Hinge Lever and Hinge Roller Lever

- Subminiature switch (12.8 x 6.5 x 5.8 (W x H x D)) ideal for PCB mounting.
- Incorporating a reverse mechanism made with two highly precise split springs which ensures a long service life (1,000,000 operations).
- Two-stage bottom different in level and insertion terminals prevents flux penetration.
- PCB, self-standing, solder, and right angle terminals are available.
- Ideal for home electronics equipment, audio equipment, office machines, and communications equipment.



Ordering Information

Actuator	Terminals	Microvoltage/current load		Standard	
		0.1 A		1 A	3 A
		Low operating force (75 gf)	General-purpose (150 gf)	Low operating force (75 gf)	General-purpose (150 gf)
Pin plunger 	PCB terminals	D2F-01F	D2F-01	D2F-F	D2F
	Self-clinching terminals	D2F-01F-T	D2F-01-T	D2F-F-T	D2F-T
	Solder terminals	D2F-01F-D	D2F-01-D	D2F-F-D	D2F-D
	Right angle terminals	D2F-01F-A	D2F-01-A	D2F-F-A	D2F-A
Hinge lever 	PCB terminals	D2F-01FL	D2F-01L	D2F-FL	D2F-L
	Self-clinching terminals	D2F-01FL-T	D2F-01L-T	D2F-FL-T	D2F-L-T
	Solder terminals	D2F-01FL-D	D2F-01L-D	D2F-FL-D	D2F-L-D
	Right angle terminals	D2F-01FL-A	D2F-01L-A	D2F-FL-A	D2F-L-A
Simulated hinge lever 	PCB terminals	D2F-01FL3	D2F-01L3	D2F-FL3	D2F-L3
	Self-clinching terminals	D2F-01FL3-T	D2F-01L3-T	D2F-FL3-T	D2F-L3-T
	Solder terminals	D2F-01FL3-D	D2F-01L3-D	D2F-FL3-D	D2F-L3-D
	Right angle terminals	D2F-01FL3-A	D2F-01L3-A	D2F-FL3-A	D2F-L3-A
Hinge roller lever 	PCB terminals	D2F-01FL2	D2F-01L2	D2F-FL2	D2F-L2
	Self-clinching terminals	D2F-01FL2-T	D2F-01L2-T	D2F-FL2-T	D2F-L2-T
	Solder terminals	D2F-01FL2-D	D2F-01L2-D	D2F-FL2-D	D2F-L2-D
	Right angle terminals	D2F-01FL2-A	D2F-01L2-A	D2F-FL2-A	D2F-L2-A

Specifications

■ Ratings

OF max.		Standard		Microvoltage/current load	
		150 g	75 g	150 g	75 g
Item		Resistive load			
Rated voltage	125 VAC	3 A	1 A	---	
	30 VDC	2 A	0.5 A	0.1 A	

Note: Consult your OMRON representative before using the switch with inductive or motor loads.

■ Approved Standards

UL (File No. E32667)/CSA (LR21642)

D2F-01 series: 0.1 A at 30 VDC

D2F-F series: 1 A at 125 VAC, 0.5 A at 30 VDC (100,000 cycles)

D2F-□ series: 3 A at 125 VAC, 2 A at 30 VDC

Contact Form

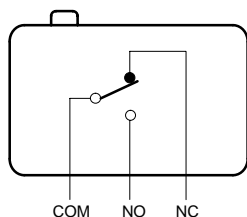

■ Characteristics

Operating speed	1 to 500 mm/s (at pin plunger)
Operating frequency (at pin plunger)	Mechanical: 200 operations/min Electrical: 30 operations/min
Insulation resistance	100 MΩ min. (at 500 VDC)
Contact resistance	Standard: 30 mΩ max. (initial value) Microvoltage/current load: 100 mΩ max. (initial value)
Dielectric strength	600 VAC, 50/60 Hz for 1 min between contacts of the same polarity 1,500 VAC, 50/60 Hz for 1 min between current-carrying metal parts and ground, and between each terminal and non-current-carrying metal part
Vibration resistance	Malfunction: 10 to 55 Hz, 1.5-mm double amplitude
Shock resistance	Malfunction: 300 m/s ² (approx. 30G)
Life expectancy	Mechanical: 1,000,000 operations min. (OT value) Electrical: 30,000 operations min.
Ambient temperature	Operating: -25°C to 85° (with no icing)
Ambient humidity	Operating: 85% max.
Weight (at pin plunger)	Approx. 0.5 g

■ Operating Characteristics

Model	D2F□, D2F-01□	D2F-F□, D2F-01F□	D2F-L□, D2F-01L□	D2F-FL□, D2F-01FL□
OF max.	1.47 N (150 gf)	0.74 N (75 gf)	0.78 N (80 gf)	0.25 N (25 gf)
RF min.	0.20 N (20 gf)	0.05 N (5 gf)	0.05 N (5 gf)	0.02 N (2 gf)
PT max.	0.5 mm	0.5 mm	---	---
OT min.	0.25 mm	0.25 mm	0.55 mm	0.55 mm
MD max.	0.12 mm	0.12 mm	0.5 mm	0.5 mm
FP max.	---	---	10 mm	
OP	5.5±0.3 mm		6.8±1.5 mm	

Model	D2F-L3□, D2F-01L3□	D2F-FL3□, D2F-01FL3□	D2F-L2□, D2F-01L2□	D2F-FL2□, D2F-01FL2□
OF max.	0.78 N (80 gf)	0.39 N (40 gf)	0.78 N (80 gf)	0.39 N (40 gf)
RF min.	0.05 N (5 gf)	0.02 N (2 gf)	0.05 N (5 gf)	0.02 N (2 gf)
OT min.	0.5 mm	0.5 mm	0.55 mm	0.55 mm
MD max.	0.45 mm	0.45 mm	0.5 mm	0.5 mm
FP max.	13 mm		16.5 mm	
OP	8.5±1.2 mm		13±2 mm	

Engineering Data

Mechanical Life Expectancy

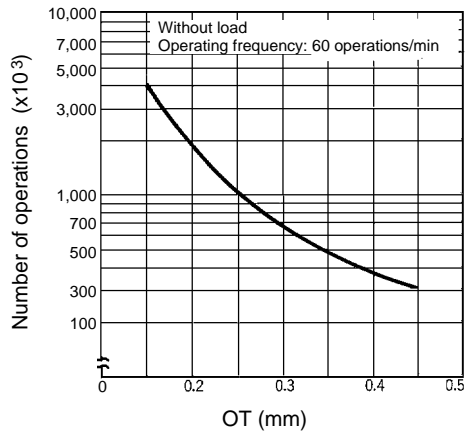

Electrical Life Expectancy

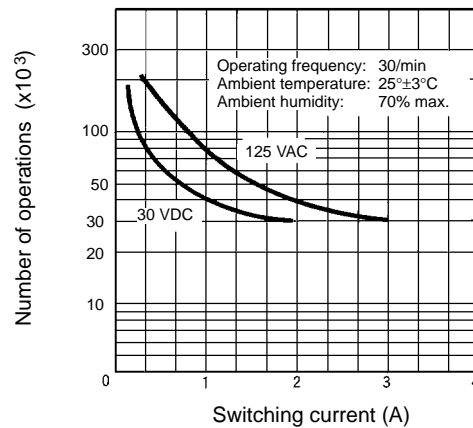

Dimensions

- Note:**
1. All units are in millimeters unless otherwise indicated.
 2. Unless otherwise specified, a tolerance of ± 0.4 mm applies to all dimensions.
 3. The following illustrations and drawings are for D2F models with PCB terminals. Self-standing, solder, and right angle terminals are omitted from the following drawings. Refer to page 119 for these terminals. When ordering, replace \square with the code for the terminal that you need.

Pin Plunger

- D2F- \square
- D2F-01 \square
- D2F-F \square
- D2F-01F \square

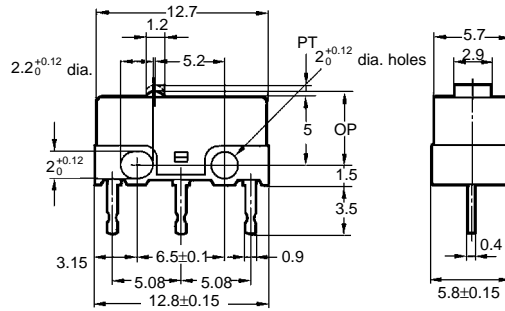
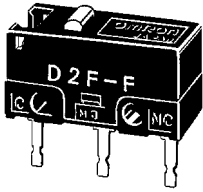

Hinge Lever

- D2F-L \square
- D2F-01L \square
- D2F-FL \square
- D2F-01FL \square

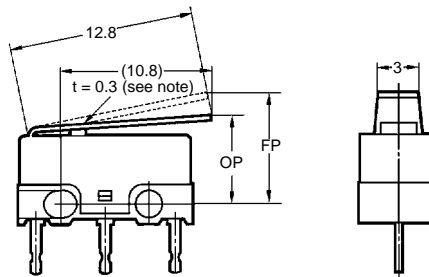
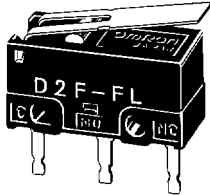

Note: Stainless steel lever

Simulate Hinge Lever

- D2F-L3 \square
- D2F-01L3 \square
- D2F-FL3 \square
- D2F-01FL3 \square

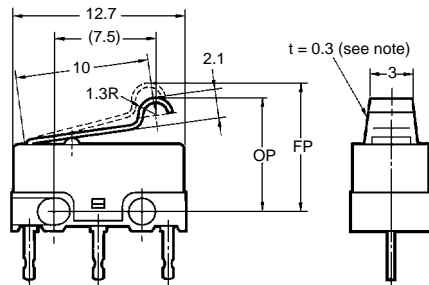

Note: Stainless steel lever

Hinge Roller Lever

- D2F-L2 \square
- D2F-01L2 \square
- D2F-FL2 \square
- D2F-01FL2 \square

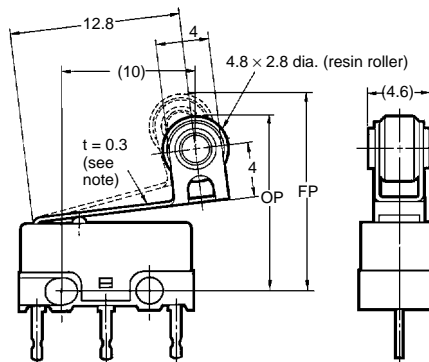
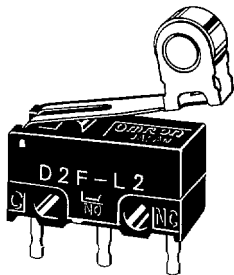

Note: Stainless steel lever

■ Terminals

PCB Terminals

D2F

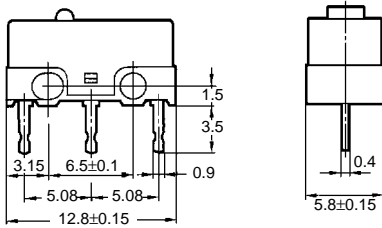

Solder Terminals

D2F-D

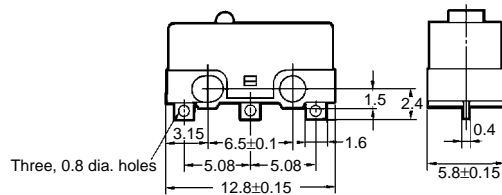

Self-clinching Terminals

D2F-T

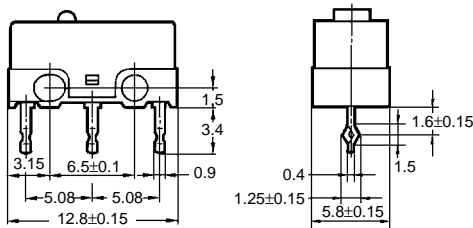

Right Angle Terminals

D2F-A

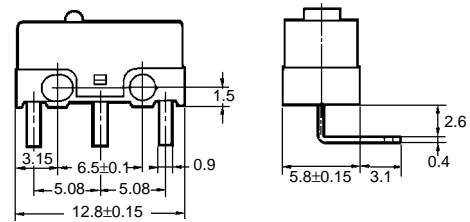

Precautions

Mounting

When mounting the switch to a PCB, refer to the following mounting dimensions. The gap between adjacent terminals is two pitches (2 x 2.54 cm).

Mounting Dimensions

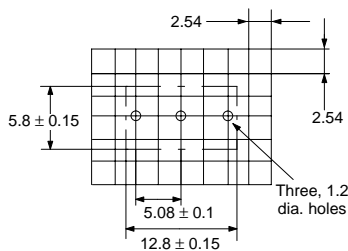

Use M2 mounting screws with plain or spring washers to mount the switch. Tighten the screws to a torque of 0.08 to 0.1 N • m (0.8 to 1 kgf • cm).

Mounting Holes

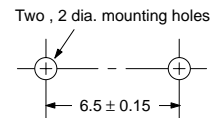

When soldering the relay terminals, use 6:4 solder and apply a soldering iron rated at 30 W and finish soldering within three seconds. After soldering, do not move the soldered terminals for at least one minute.

Make sure that each adjacent terminals of the switch are properly insulated from each other and the terminals and ground is properly insulated.

Use of molded fittings is recommended to secure the switch.

Mounting with Molded Pin

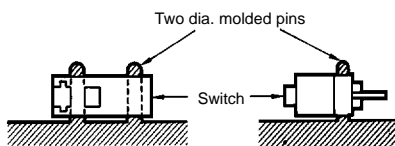

ALL DIMENSIONS SHOWN ARE IN MILLIMETERS.

To convert millimeters into inches, multiply by 0.03937. To convert grams into ounces, multiply by 0.03527.