

Schottky Barrier Rectifiers

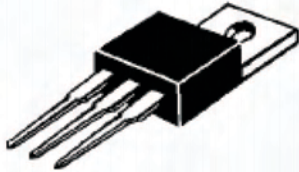

Using the schottky barrier principle with a refractory metal capable of high temperature operation metal. The proprietary barrier technology allows for reliable operation up to 175°C junction temperature. Typical application are in switching mode power supplies such as adaptors, DC/DC converters, free- wheeling and polarity protection diodes.



Features:

- Low forward voltage.
- Low switching noise.
- High current capacity.
- Guarantee reverse avalanche.
- Guard-ring for stress protection.
- Low power loss and high efficiency.
- 175°C operating junction temperature.
- Low stored charge majority carrier conduction.
- Plastic material used carries Underwriters Laboratory Flammability classification 94V-O.

**20 Amperes
200 Volts
TO-220AB**

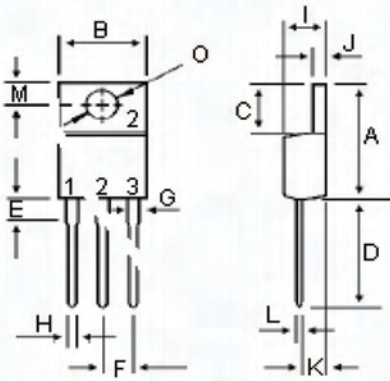

Dimensions : Millimetres

DIM	MILLIMETERS	
	MIN	MAX
A	14.68	15.32
B	9.78	10.42
C	5.02	6.52
D	13.06	14.62
E	3.57	4.07
F	2.42	2.66
G	1.12	1.36
H	0.72	0.96
I	4.22	4.98
J	1.14	1.38
K	2.20	2.98
L	0.33	0.55
M	2.48	2.98
O	3.70	3.90



Common Cathode

Schottky Barrier Rectifiers



Maximum Ratings

Characteristic	Symbol	MBR20200CT	Units
Peak Repetitive Reverse Voltage Working Peak Reverse Voltage DC Blocking Voltage	V_{RRM} V_{RWM} V_R	200	V
RMS Reverse Voltage	$V_R (RMS)$	140	
Average Rectifier Forward Current Total Device (Rated V_R), $T_C = 125^\circ C$	$I_F (AV)$	10 20	A
Peak Repetitive Forward Current (Rate V_R , Square Wave, 20kHz)	I_{FM}	20	A
Non-Repetitive Peak Surge Current (Surge applied at rate load conditions half-wave, single phase, 60Hz)	I_{FSM}	150	
Operating and Storage Junction Temperature Range	T_J, T_{STG}	-65 to +175	$^\circ C$

Thermal Resistances

Typical Thermal Resistance junction to case	$R_{\theta jc}$	3.8	$^\circ C/W$
---	-----------------	-----	--------------

Electrical Characteristics

Characteristic	Symbol	MBR20200CT	Units
Maximum Instantaneous Forward Voltage ($I_F = 10$ Amperes $T_C = 25^\circ C$) ($I_F = 10$ Amperes $T_C = 125^\circ C$)	V_F	0.95 0.85	V
Maximum Instantaneous Reverse Current (Rated DC Voltage, $T_C = 25^\circ C$) (Rated DC Voltage, $T_C = 125^\circ C$)	I_R	0.01 10	mA

Schottky Barrier Rectifiers



Forward Current Derating Curve

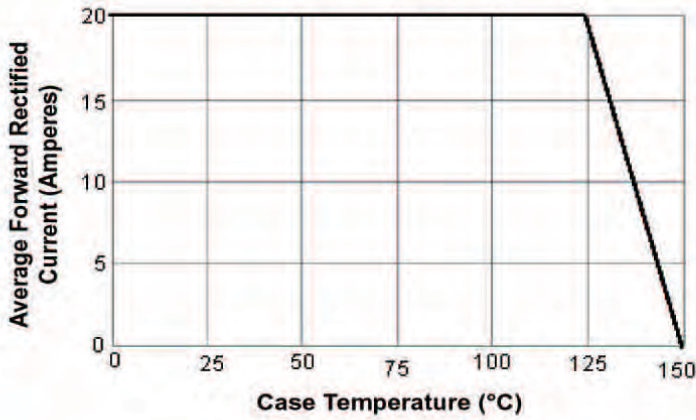

Typical Forward Characteristics

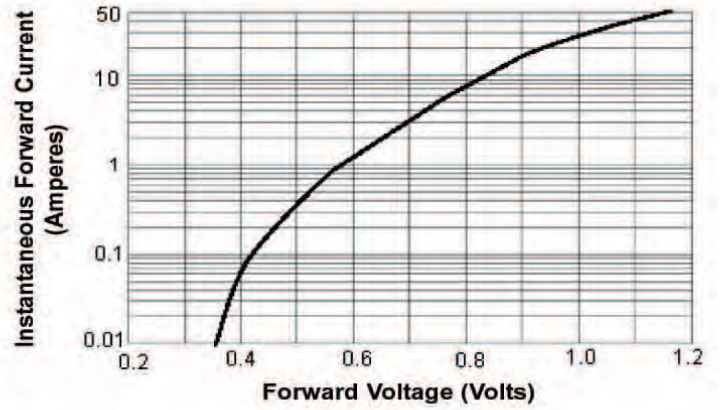

Typical Reverse Characteristics

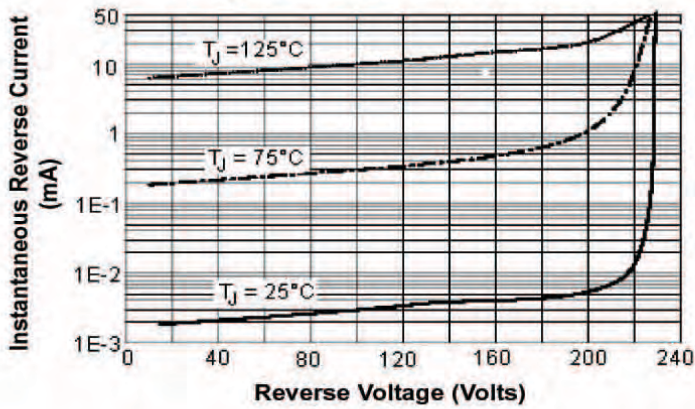

Typical Junction Capacitance

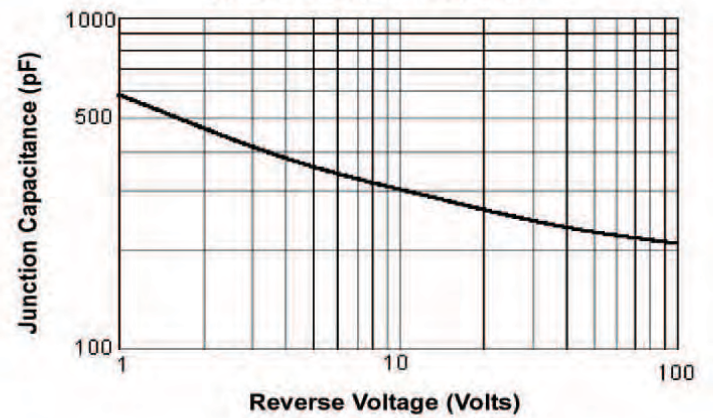

Peak Forward Surge Current

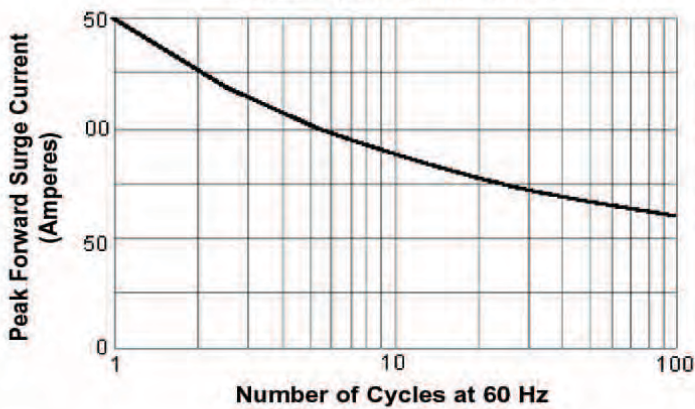

Schottky Barrier Rectifiers



Part Number Table

Description	Part Number
Schottky Barrier Rectifiers	MBR20200CT



Disclaimer This data sheet and its contents (the "Information") belong to the Premier Farnell Group (the "Group") or are licensed to it. No licence is granted for the use of it other than for information purposes in connection with the products to which it relates. No licence of any intellectual property rights is granted. The Information is subject to change without notice and replaces all data sheets previously supplied. The Information supplied is believed to be accurate but the Group assumes no responsibility for its accuracy or completeness, any error in or omission from it or for any use made of it. Users of this data sheet should check for themselves the Information and the suitability of the products for their purpose and not make any assumptions based on information included or omitted. Liability for loss or damage resulting from any reliance on the Information or use of it (including liability resulting from negligence or where the Group was aware of the possibility of such loss or damage arising) is excluded. This will not operate to limit or restrict the Group's liability for death or personal injury resulting from its negligence. SPC Multicomp is the registered trademark of the Group. © Premier Farnell plc 2010.

<http://www.farnell.com>
<http://www.newark.com>
<http://www.cpc.co.uk>

