

## Power Phototriac

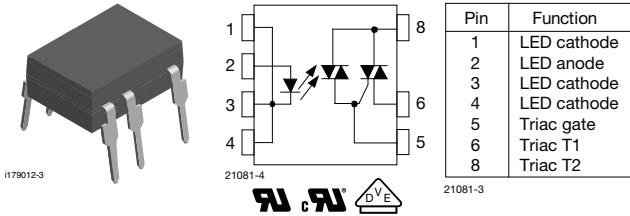

### FEATURES

- Maximum trigger current ( $I_{FT}$ ): 10 mA
- Isolation test voltage 5300 V<sub>RMS</sub>
- Peak off-state voltage 600 V
- Load current 1 A<sub>RMS</sub>
- dV/dt of 210 V/μs
- DIP-8 package
- Pure tin leads
- Compliant to RoHS Directive 2002/95/EC

**RoHS**  
COMPLIANT

### DESCRIPTION

The VO2223A is an optically couple phototriac driving a power triac in a DIP-8 package. It provides a 5300 V of input to output isolation.

### APPLICATIONS

- Home appliances (air conditioners, microwave ovens, washing machines, personal hygiene systems, refrigerators, fan heaters, inductive heating cooker, water heaters, etc.)
- Industrial equipments

### AGENCY APPROVALS

- UL - E52744 system code H
- cUL - E52744 system code H
- VDE - DIN EN60747-5-2 (VDE 0884)

### ORDERING INFORMATION

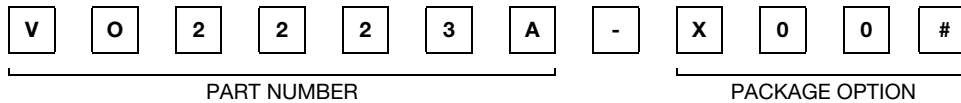

AGENCY CERTIFIED/PACKAGE	TRIGGER, CURRENT $I_{FT}$ (mA)
UL, cUL	10
DIP-8	VO2223A
VDE	10
DIP-8	VO2223A-X001

### ABSOLUTE MAXIMUM RATINGS <sup>(1)</sup> ( $T_{amb} = 25\text{ }^{\circ}\text{C}$ , unless otherwise specified)

PARAMETER	TEST CONDITION	SYMBOL	VALUE	UNIT
<b>INPUT</b>				
LED continuous forward current		$I_F$	50	mA
LED reverse voltage		$V_R$	5	V
<b>OUTPUT</b>				
Repetitive peak off-state voltage	Sine wave, 50 Hz to 60 Hz, gate open	$V_{DRM}$	600	V
On-state RMS current		$I_{T(RMS)}$	1	A
Peak non-repetitive surge current (50 Hz, peak)		$I_{TSM}$	10	A
<b>COUPLER</b>				
Total power dissipation <sup>(3)</sup>		$P_{diss}$	1.2	W
Ambient temperature range		$T_{amb}$	- 40 to + 85	$^{\circ}\text{C}$
Storage temperature range		$T_{stg}$	- 40 to + 125	$^{\circ}\text{C}$
Soldering temperature <sup>(2)</sup>	$t \leq 10\text{ s max.}$	$T_{slid}$	260	$^{\circ}\text{C}$
Isolation test voltage	for 1 s	$V_{ISO}$	5300	$V_{RMS}$

### Notes

- (1) Stresses in excess of the absolute maximum ratings can cause permanent damage to the device. Functional operation of the device is not implied at these or any other conditions in excess of those given in the operational sections of this document. Exposure to absolute maximum ratings for extended periods of the time can adversely affect reliability.
- (2) Refer to wave profile for soldering conditions for through hole devices.
- (3) Total power dissipation value is based on 2S2P PCB.

**ABSOLUTE MAXIMUM RATING CURVES**

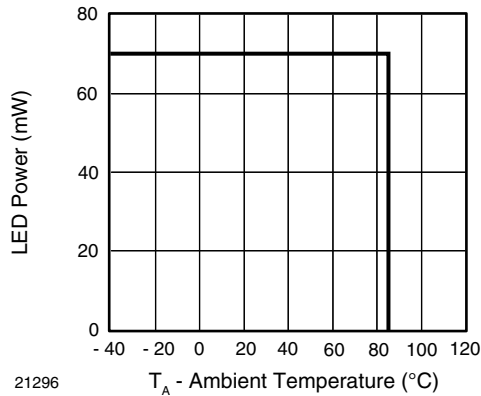

Fig. 1 - Power Dissipation vs. Temperature

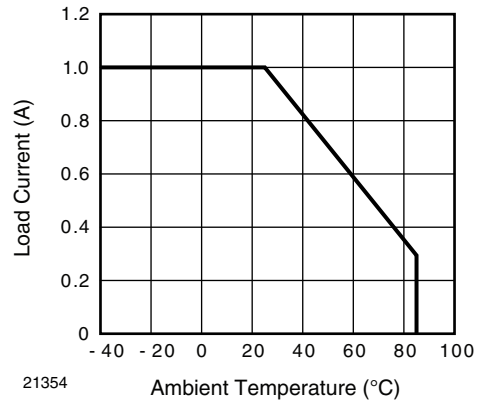

Fig. 2 - Allowable Load Current vs. Ambient Temperature

**Note**

- The allowable load current was calculated out under a given operating conditions and only for reference:  
LED power:  $Q_E = 0.015 \text{ W}$ ,  $\theta_{BA} \text{ (4-layer)} = 30 \text{ }^\circ\text{C/W}$

<b>ELECTRICAL CHARACTERISTICS</b> ( $T_{amb} = 25 \text{ }^\circ\text{C}$ , unless otherwise specified)						
PARAMETER	TEST CONDITION	SYMBOL	MIN.	TYP.	MAX.	UNIT
<b>INPUT</b>						
LED trigger current	$V_T = 6 \text{ V}$	$I_{FT}$			10	mA
Input reverse current	$V_R = 5 \text{ V}$	$I_R$			10	$\mu\text{A}$
LED forward voltage	$I_F = 10 \text{ mA}$	$V_F$	0.9		1.4	V
<b>OUTPUT</b>						
Peak on-state voltage	$I_{TM} = 1 \text{ A}$	$V_{TM}$			1.7	V
Peak off-state current	$V_{DRM} = 600 \text{ V}$ , $T_A = 110 \text{ }^\circ\text{C}$	$I_{DRM}$			100	$\mu\text{A}$
Holding current	$R_L = 100 \text{ } \Omega$	$I_H$			25	mA
Critical rate of rise of off-state voltage	$V_{IN} = 400 \text{ V}_{RMS}$ (fig. 3)	$dV/dt$		210		$\text{V}/\mu\text{s}$
Critical rate of rise of commutating voltage	$V_{IN} = 240 \text{ V}_{RMS}$ , $I_T = 1 \text{ A}_{RMS}$ (fig. 3)	$dV/dt \text{ (c)}$		0.7		$\text{V}/\mu\text{s}$

**Note**

- Minimum and maximum values are testing requirements. Typical values are characteristics of the device and are the result of engineering evaluations. Typical values are for information only and are not part of the testing requirements.

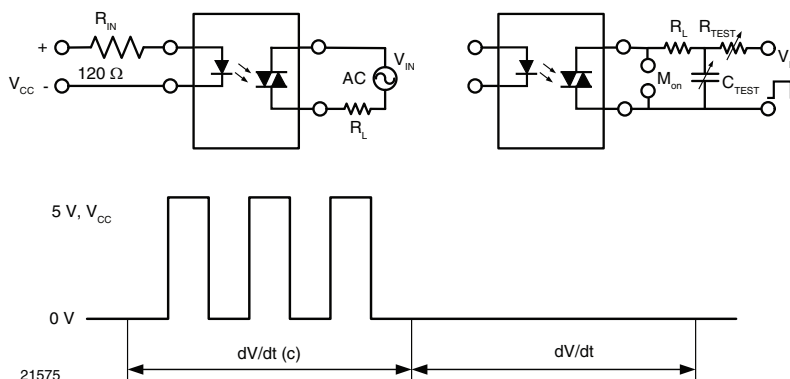

Fig. 3 - dV/dt Test Circuit

SAFETY AND INSULATION RATINGS						
PARAMETER	TEST CONDITION	SYMBOL	MIN.	TYP.	MAX.	UNIT
Climatic classification	IEC 68 part 1			40/85/21		
Pollution degree	DIN VDE 0109			2		
Tracking resistance (comparative tracking index)	Insulation group IIIa	CTI	175			
Highest allowable overvoltage	Transient overvoltage	$V_{IOTM}$	8000			$V_{peak}$
Maximum working insulation voltage	Recurring peak voltage	$V_{IORM}$	890			$V_{peak}$
Insulation resistance at 25 °C	$V_{IO} = 500 V$	$R_{IS}$			$\geq 10^{12}$	$\Omega$
Insulation resistance at $T_S$	$V_{IO} = 500 V$	$R_{IS}$			$\geq 10^9$	$\Omega$
Insulation resistance at 100 °C	$V_{IO} = 500 V$	$R_{IS}$			$\geq 10^{11}$	$\Omega$
Partial discharge test voltage	Method b, $V_{pd} = V_{IORM} \times 1.6$	$V_{pd}$			1424	$V_{peak}$
Safety limiting values - maximum values allowed in the event of a failure	Case temperature	$T_{SI}$			165	°C
	Input current	$I_{SI}$			150	mA
	Output power	$P_{SO}$			2000	mW
Minimum external air gap (clearance distance)	Measured from input terminals to output terminals, shortest distance through air		$\geq 7$			mm
Minimum external tracking (creepage distance)	Measured from input terminals to output terminals, shortest distance path along body		$\geq 7$			mm

**Note**

- This phototriac coupler is suitable for "safe electrical insulation" only within the safety ratings. Compliance with safety ratings shall be ensured by means of protective circuits.

**TYPICAL CHARACTERISTICS** ( $T_{amb} = 25\text{ °C}$ , unless otherwise specified)

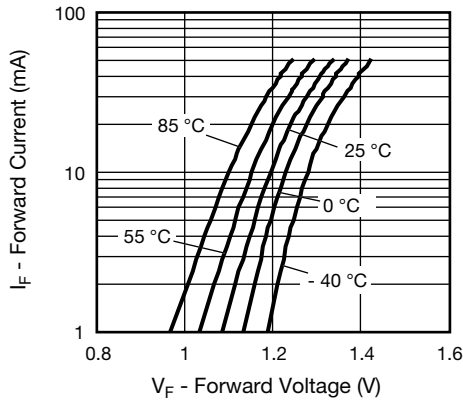

Fig. 4 - Forward Current vs. Forward Voltage

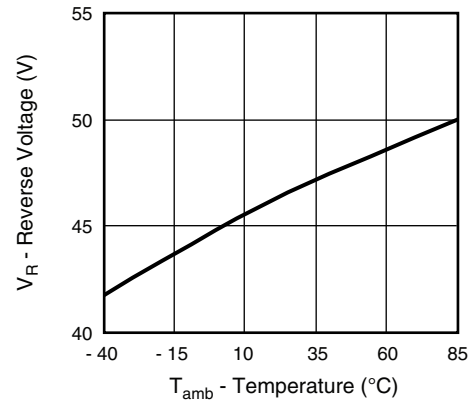

Fig. 5 - Reverse Voltage vs. Temperature

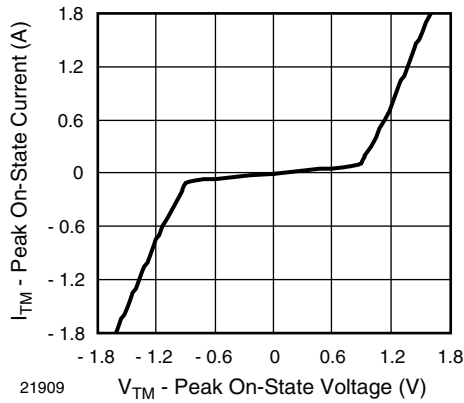

Fig. 6 - On-State Current vs. On-State Voltage

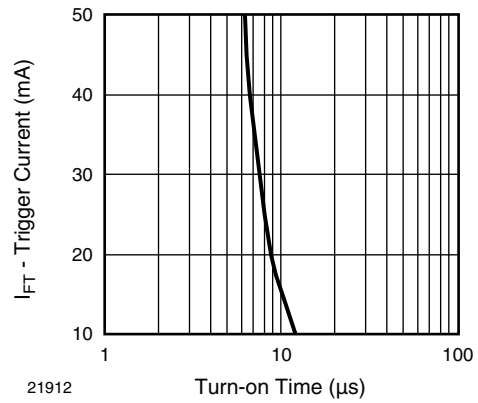

Fig. 9 - Trigger Input Current vs. Turn-on Time

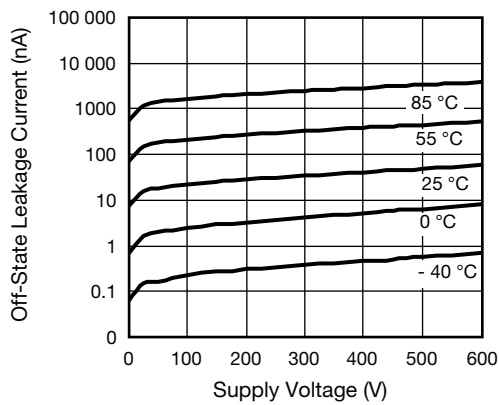

Fig. 7 - Off-State Leakage Current vs. Voltage

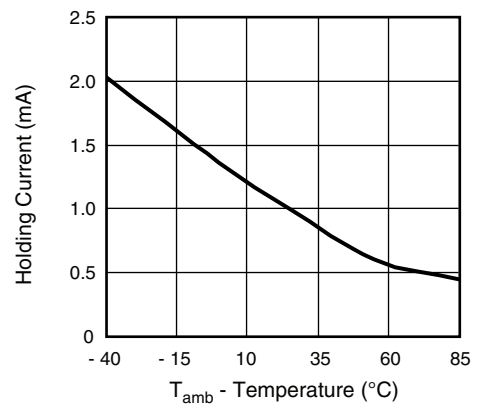

Fig. 10 - Normalized Holding Current vs. Temperature

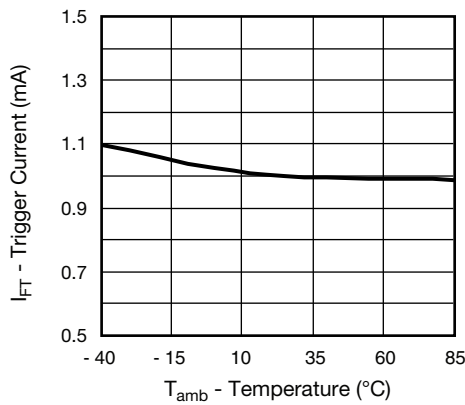

Fig. 8 - Normalized Trigger Input Current vs. Temperature

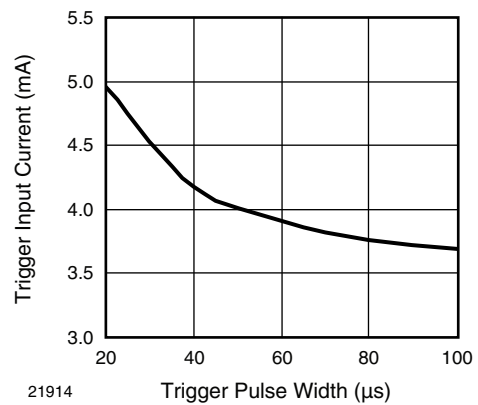

Fig. 11 - Trigger Current vs. Trigger Pulse Width

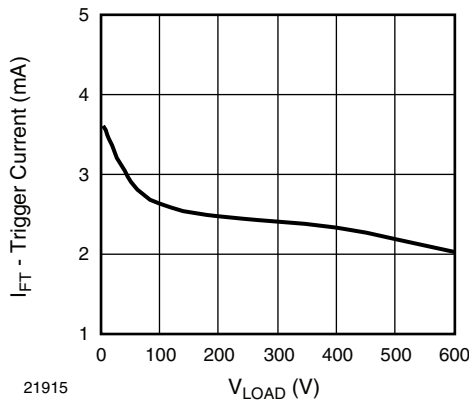
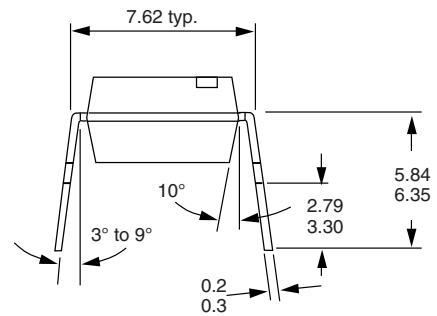
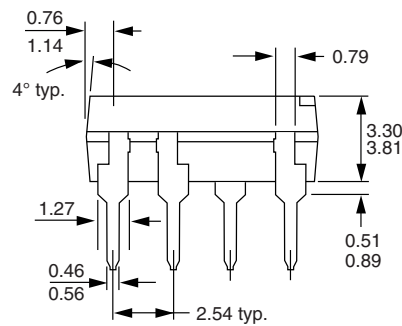
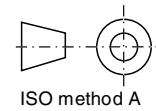
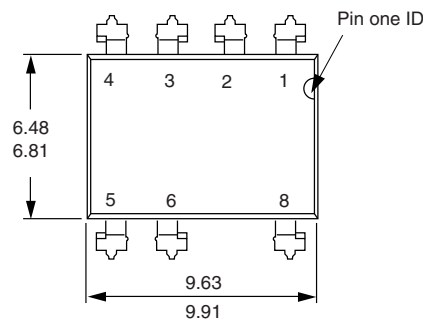

Fig. 12 - Trigger Current vs. V\_LOAD

**PACKAGE DIMENSIONS** in millimeters



i178006-1

**PACKAGE MARKING**



21764-49



## Disclaimer

All product specifications and data are subject to change without notice.

Vishay Intertechnology, Inc., its affiliates, agents, and employees, and all persons acting on its or their behalf (collectively, "Vishay"), disclaim any and all liability for any errors, inaccuracies or incompleteness contained herein or in any other disclosure relating to any product.

Vishay disclaims any and all liability arising out of the use or application of any product described herein or of any information provided herein to the maximum extent permitted by law. The product specifications do not expand or otherwise modify Vishay's terms and conditions of purchase, including but not limited to the warranty expressed therein, which apply to these products.

No license, express or implied, by estoppel or otherwise, to any intellectual property rights is granted by this document or by any conduct of Vishay.

The products shown herein are not designed for use in medical, life-saving, or life-sustaining applications unless otherwise expressly indicated. Customers using or selling Vishay products not expressly indicated for use in such applications do so entirely at their own risk and agree to fully indemnify Vishay for any damages arising or resulting from such use or sale. Please contact authorized Vishay personnel to obtain written terms and conditions regarding products designed for such applications.

Product names and markings noted herein may be trademarks of their respective owners.