

## High Speed Infrared Emitting Diodes, 850 nm, GaAlAs, DH

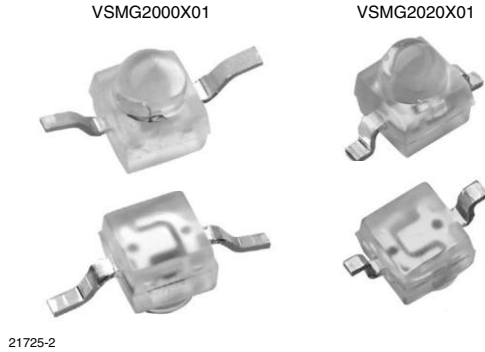

### DESCRIPTION

VSMG2000X01 series are infrared, 850 nm emitting diodes in GaAlAs (DH) technology with high radiant power and high speed, molded in clear, untinted plastic packages (with lens) for surface mounting (SMD).

### FEATURES

- Package type: surface mount
- Package form: GW, RGW
- Dimensions (L x W x H in mm): 2.3 x 2.3 x 2.8
- AEC-Q101 qualified
- Peak wavelength:  $\lambda_p = 850$  nm
- High reliability
- High radiant power
- High radiant intensity
- Angle of half intensity:  $\phi = \pm 12^\circ$
- Low forward voltage
- Suitable for high pulse current operation
- Terminal configurations: gullwing or reserve gullwing
- Package matches with detector VEMD2000X01 series
- Floor life: 4 weeks, MSL 2a, acc. J-STD-020
- Compliant to RoHS directive 2002/95/EC and in accordance to WEEE 2002/96/EC
- Halogen-free according to IEC 61249-2-21 definition
- Find out more about Vishay's Automotive Grade Product requirements at: [www.vishay.com/applications](http://www.vishay.com/applications)

AUTOMOTIVE  
GRADE



RoHS  
COMPLIANT  
HALOGEN  
FREE

### APPLICATIONS

- IrDA compatible data transmission
- IR-illumination (CCTV)
- Miniature light barrier
- Photointerrupters
- Optical switch
- Shaft encoders
- IR emitter source for proximity applications

### PRODUCT SUMMARY

COMPONENT	$I_e$ (mW/sr)	$\phi$ (deg)	$\lambda_p$ (nm)	$t_r$ (ns)
VSMG2000X01	40	$\pm 12$	850	20
VSMG2020X01	40	$\pm 12$	850	20

#### Note

Test conditions see table "Basic Characteristics"

### ORDERING INFORMATION

ORDERING CODE	PACKAGING	REMARKS	PACKAGE FORM
VSMG2000X01	Tape and reel	MOQ: 6000 pcs, 6000 pcs/reel	Reverse gullwing
VSMG2020X01	Tape and reel	MOQ: 6000 pcs, 6000 pcs/reel	Gullwing

#### Note

MOQ: minimum order quantity

### ABSOLUTE MAXIMUM RATINGS

PARAMETER	TEST CONDITION	SYMBOL	VALUE	UNIT
Reverse voltage		$V_R$	5	V
Forward current		$I_F$	100	mA

ABSOLUTE MAXIMUM RATINGS				
PARAMETER	TEST CONDITION	SYMBOL	VALUE	UNIT
Peak forward current	$t_p/T = 0.5$ , $t_p = 100 \mu s$	$I_{FM}$	200	mA
Surge forward current	$t_p = 100 \mu s$	$I_{FSM}$	1	A
Power dissipation		$P_V$	170	mW
Junction temperature		$T_j$	100	$^{\circ}C$
Operating temperature range		$T_{amb}$	- 40 to + 85	$^{\circ}C$
Storage temperature range		$T_{stg}$	- 40 to + 100	$^{\circ}C$
Soldering temperature	Acc. figure 9, J-STD-020	$T_{sd}$	260	$^{\circ}C$
Thermal resistance junction/ambient	J-STD-051, leads 7 mm, soldered on PCB	$R_{thJA}$	250	K/W

**Note**

$T_{amb} = 25 \text{ }^{\circ}C$ , unless otherwise specified

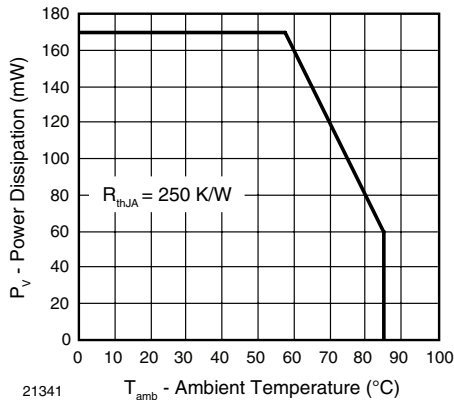

Fig. 1 - Power Dissipation Limit vs. Ambient Temperature

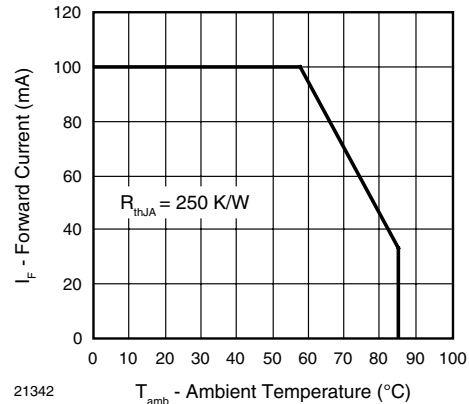

Fig. 2 - Forward Current Limit vs. Ambient Temperature

BASIC CHARACTERISTICS						
PARAMETER	TEST CONDITION	SYMBOL	MIN.	TYP.	MAX.	UNIT
Forward voltage	$I_F = 100 \text{ mA}$ , $t_p = 20 \text{ ms}$	$V_F$	1.25	1.45	1.7	V
	$I_F = 1 \text{ A}$ , $t_p = 100 \mu s$	$V_F$		2.3		V
Temperature coefficient of $V_F$	$I_F = 1 \text{ mA}$	$TK_{V_F}$		- 1.8		mV/K
	$I_F = 100 \text{ mA}$	$TK_{V_F}$		- 1.1		mV/K
Reverse current	$V_R = 5 \text{ V}$	$I_R$			10	$\mu A$
Junction capacitance	$V_R = 0 \text{ V}$ , $f = 1 \text{ MHz}$ , $E = 0 \text{ mW/cm}^2$	$C_J$		125		pF
Radiant intensity	$I_F = 100 \text{ mA}$ , $t_p = 20 \text{ ms}$	$I_e$	20	40	60	mW/sr
	$I_F = 1 \text{ A}$ , $t_p = 100 \mu s$	$I_e$		350		mW/sr
Radiant power	$I_F = 100 \text{ mA}$ , $t_p = 20 \text{ ms}$	$\phi_e$		40		mW
Temperature coefficient of $\phi_e$	$I_F = 100 \text{ mA}$	$TK_{\phi_e}$		- 0.35		%/K
Angle of half intensity		$\varphi$		$\pm 12$		deg
Peak wavelength	$I_F = 30 \text{ mA}$	$\lambda_p$	830	850	870	nm
Spectral bandwidth	$I_F = 30 \text{ mA}$	$\Delta\lambda$		35		nm
Temperature coefficient of $\lambda_p$	$I_F = 30 \text{ mA}$	$TK_{\lambda_p}$		0.25		nm/K
Rise time	$I_F = 100 \text{ mA}$ , 20 % to 80 %	$t_r$		20		ns
Fall time	$I_F = 100 \text{ mA}$ , 20 % to 80 %	$t_f$		20		ns
Cut-off frequency	$I_{DC} = 70 \text{ mA}$ , $I_{AC} = 30 \text{ mA pp}$	$f_c$		23		MHz
Virtual source diameter		$d$		1.5		mm

**Note**

$T_{amb} = 25 \text{ }^{\circ}C$ , unless otherwise specified

### BASIC CHARACTERISTICS

$T_{amb} = 25\text{ }^{\circ}\text{C}$ , unless otherwise specified

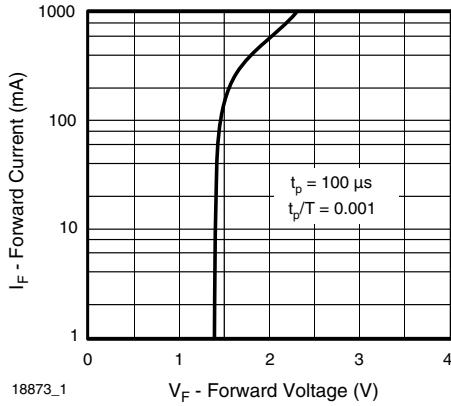

Fig. 3 - Forward Current vs. Forward Voltage

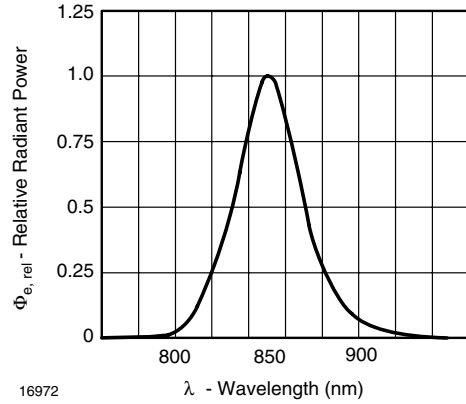

Fig. 6 - Relative Radiant Power vs. Wavelength

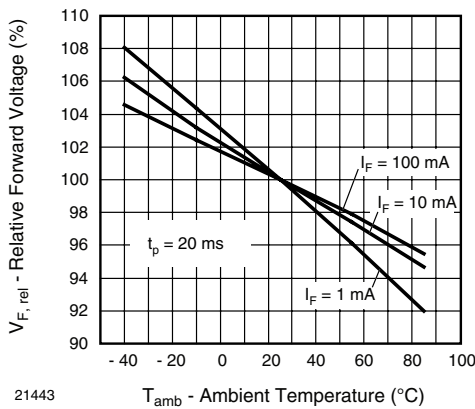

Fig. 4 - Relative Forward Voltage vs. Ambient Temperature

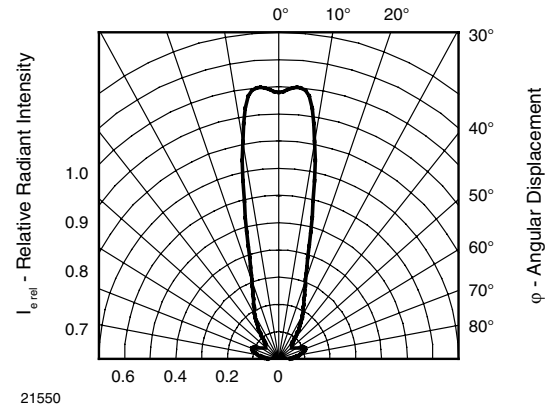

Fig. 7 - Relative Radiant Intensity vs. Angular Displacement

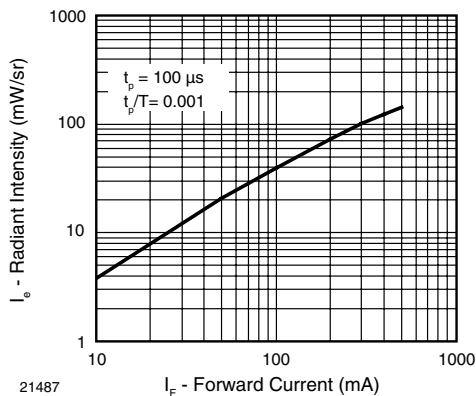

Fig. 5 - Radiant Intensity vs. Forward Current

# VSMG2000X01, VSMG2020X01



Vishay Semiconductors High Speed Infrared Emitting Diodes,  
850 nm, GaAlAs, DH

## SOLDER PROFILE

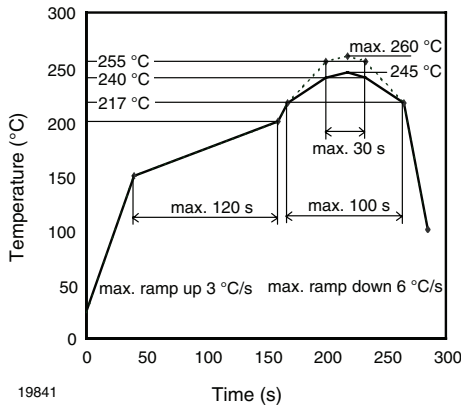

Fig. 8 - Lead (Pb)-free Reflow Solder Profile acc. J-STD-020

## DRYPACK

Devices are packed in moisture barrier bags (MBB) to prevent the products from moisture absorption during transportation and storage. Each bag contains a desiccant.

## FLOOR LIFE

Floor life (time between soldering and removing from MBB) must not exceed the time indicated on MBB label:

Floor life: 4 weeks

Conditions:  $T_{amb} < 30\text{ °C}$ , RH < 60 %

Moisture sensitivity level 2a, acc. to J-STD-020.

## DRYING

In case of moisture absorption devices should be baked before soldering. Conditions see J-STD-020 or label. Devices taped on reel dry using recommended conditions 192 h at 40 °C (+ 5 °C), RH < 5 %.

## PACKAGE DIMENSIONS in millimeters: VSMG2000

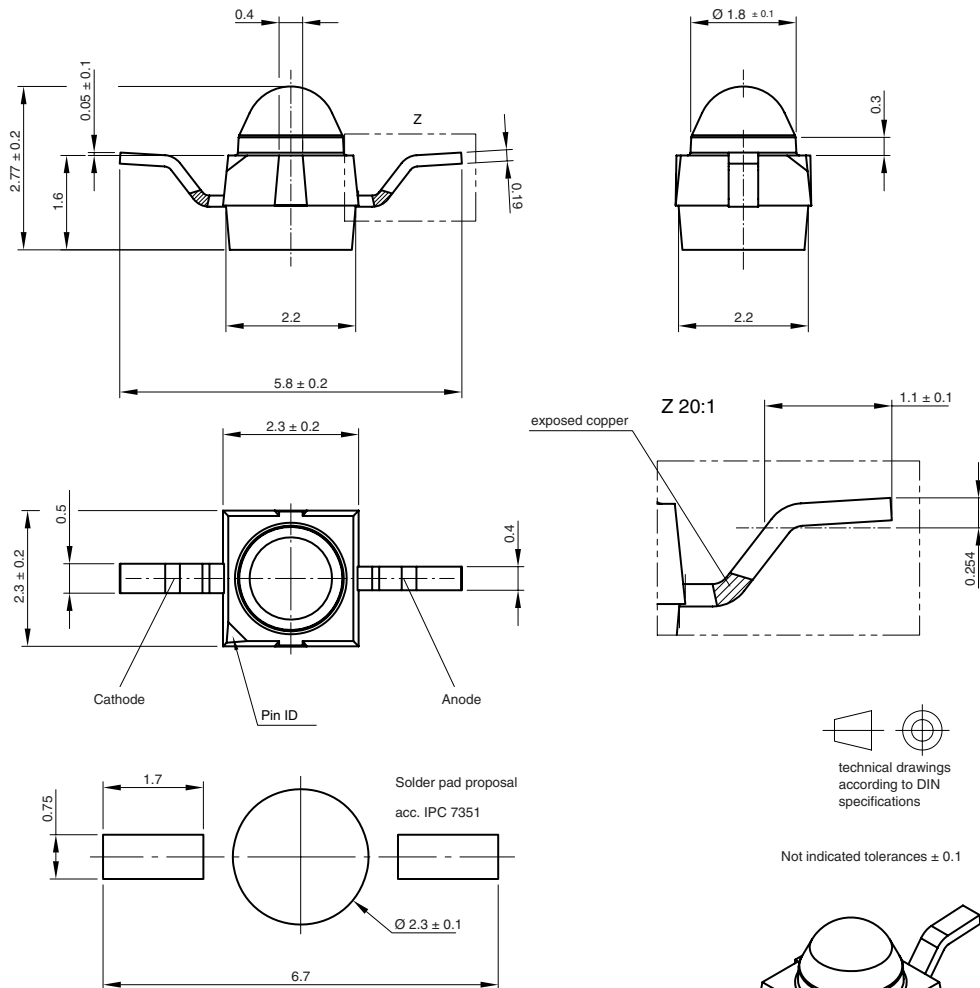

Drawing-No.: 6.544-5391.02-4  
Issue: 1; 26.09.08  
21517

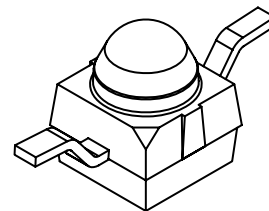



# VSMG2000X01, VSMG2020X01

High Speed Infrared Emitting Diodes, Vishay Semiconductors  
850 nm, GaAlAs, DH

## PACKAGE DIMENSIONS in millimeters: VSMG2020

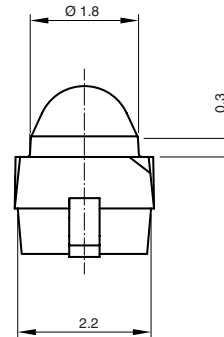
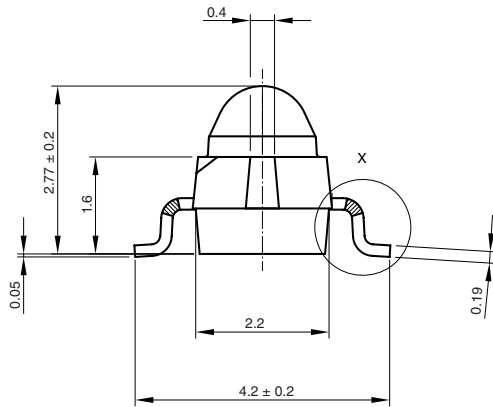

X 20:1

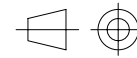
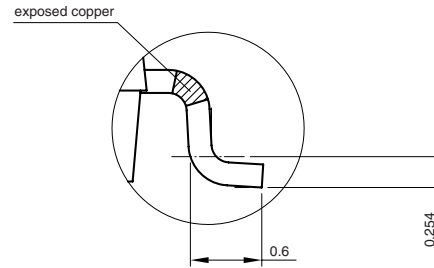
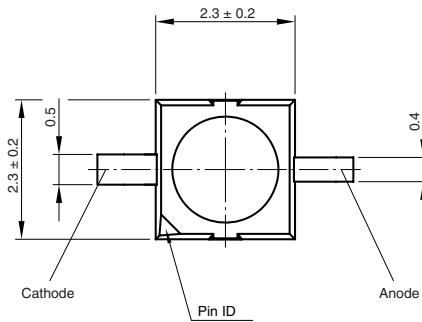

technical drawings  
according to DIN  
specifications

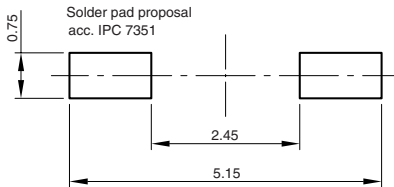

Not indicated tolerances ± 0.1

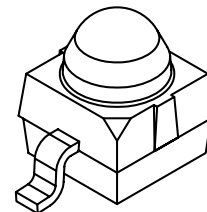

Drawing-No.: 6.544-5383.02-4  
Issue: 3; 26.09.08  
21488

# VSMG2000X01, VSMG2020X01



Vishay Semiconductors High Speed Infrared Emitting Diodes,  
850 nm, GaAlAs, DH

## TAPING AND REEL DIMENSIONS in millimeters: VSMG2000

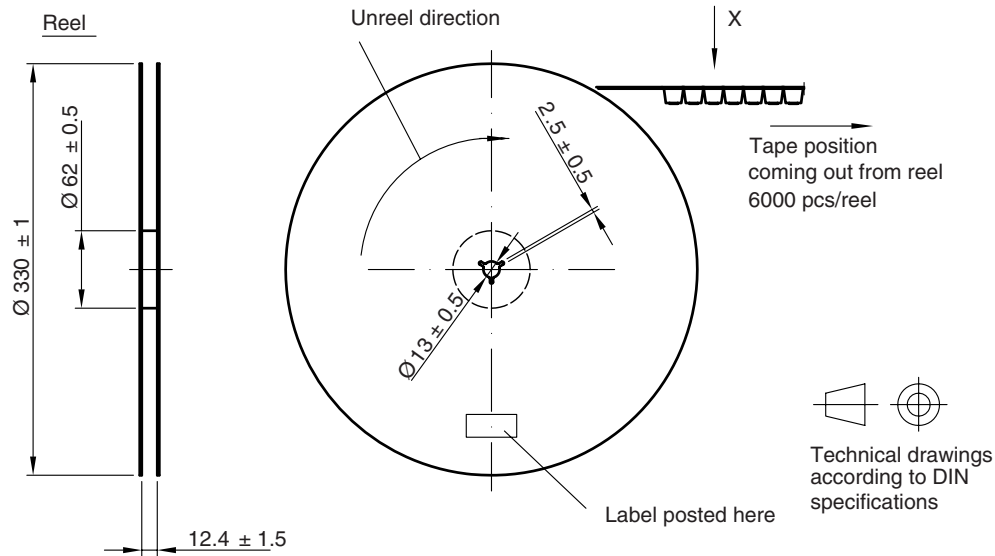

Leader and trailer tape:

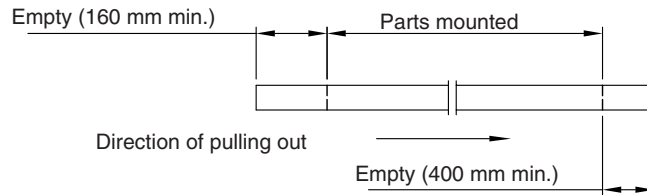

Terminal position in tape

Device	Lead I	Lead II
VEMT2000	Collector	Emitter
VEMT2500		
VEMD2000	Cathode	Anode
VSMB2000		

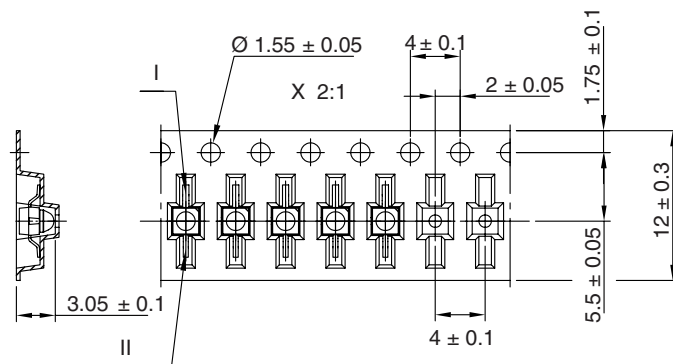

Drawing-No.: 9.800-5100.01-4  
Issue: X; 29.04.09  
21572



# VSMG2000X01, VSMG2020X01

High Speed Infrared Emitting Diodes, Vishay Semiconductors  
850 nm, GaAlAs, DH

## TAPING AND REEL DIMENSIONS in millimeters: VSMG2020

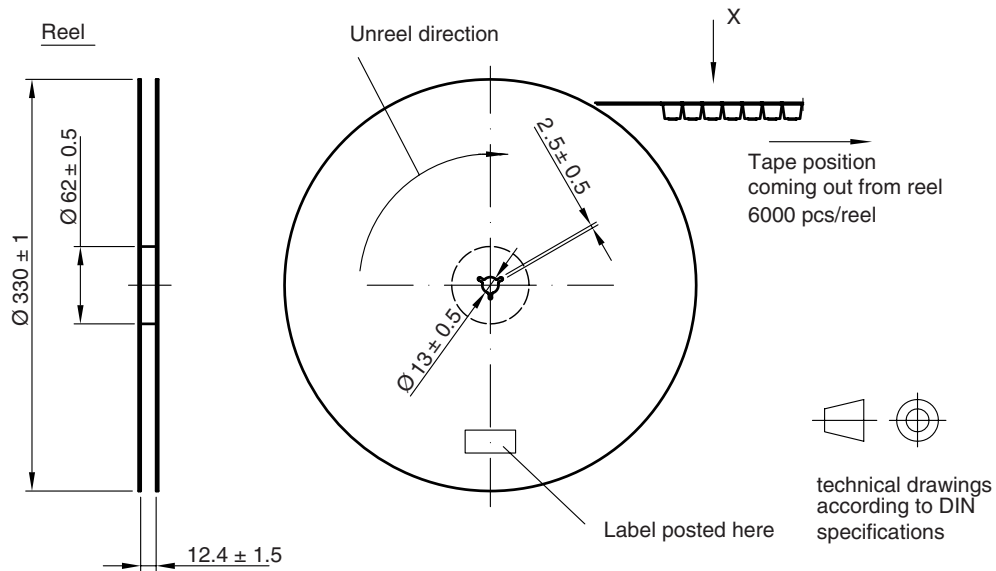

### Leader and trailer tape:

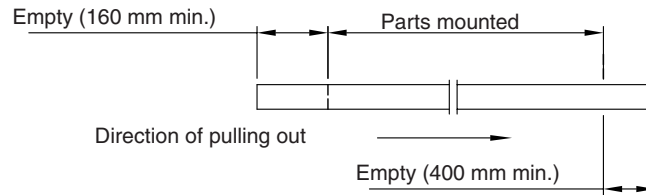

### Terminal position in tape

Device	Lead I	Lead II
VEMT2020	Collector	Emitter
VEMT2520	Collector	Emitter
VSMB2020	Cathode	Anode
VEMD2020	Cathode	Anode

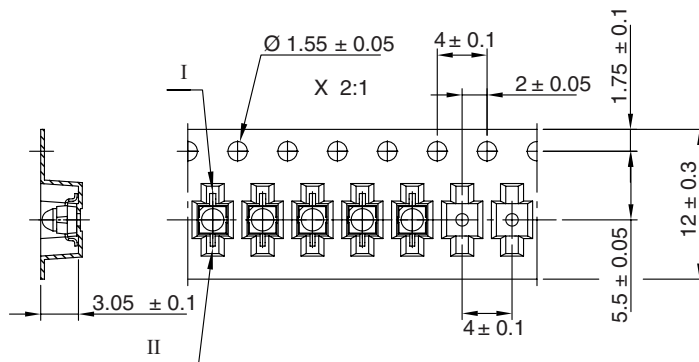

Drawing-No.: 9.800-5091.01-4

Issue: X; 29.04.09

21571



## Disclaimer

All product specifications and data are subject to change without notice.

Vishay Intertechnology, Inc., its affiliates, agents, and employees, and all persons acting on its or their behalf (collectively, "Vishay"), disclaim any and all liability for any errors, inaccuracies or incompleteness contained herein or in any other disclosure relating to any product.

Vishay disclaims any and all liability arising out of the use or application of any product described herein or of any information provided herein to the maximum extent permitted by law. The product specifications do not expand or otherwise modify Vishay's terms and conditions of purchase, including but not limited to the warranty expressed therein, which apply to these products.

No license, express or implied, by estoppel or otherwise, to any intellectual property rights is granted by this document or by any conduct of Vishay.

The products shown herein are not designed for use in medical, life-saving, or life-sustaining applications unless otherwise expressly indicated. Customers using or selling Vishay products not expressly indicated for use in such applications do so entirely at their own risk and agree to fully indemnify Vishay for any damages arising or resulting from such use or sale. Please contact authorized Vishay personnel to obtain written terms and conditions regarding products designed for such applications.

Product names and markings noted herein may be trademarks of their respective owners.