

# Low-frequency transistor

## UML1N

### ●Features

- 1) The 2SA1037AK and a diode are housed independently in a UMT package.

### ●Equivalent circuit

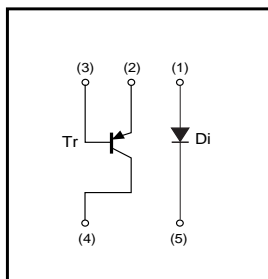

### ●External dimensions (Unit : mm)

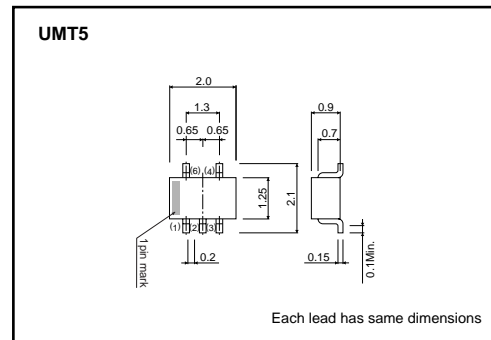

### ●Packaging specifications

Type	FML10
Package	SMT5
Marking	L10
Code	TR
Basic ordering unit(pieces)	3000

### ●Absolute maximum ratings (Ta=25°C)

Tr

Parameter	Symbol	Limits	Unit
Collector-base voltage	V <sub>CB0</sub>	-60	V
Collector-emitter voltage	V <sub>CE0</sub>	-50	V
Emitter-base voltage	V <sub>EB0</sub>	-6	V
Collector current	I <sub>C</sub>	-0.15	A
Collector power dissipatio	P <sub>C</sub>	0.15	W
Junction temperature	T <sub>J</sub>	150	°C
Storage temperature	T <sub>stg</sub>	-55 to +150	°C

Di

Parameter	Symbol	Limits	Unit
DC reverse voltage	V <sub>R</sub>	80	V
Peak reverse voltage	V <sub>RM</sub>	80	V
Mean rectifying current	I <sub>O</sub>	0.1	A
Peak forward voltage	I <sub>FM</sub>	0.3	A
Surge current	I <sub>surge</sub>	4	A
Junction temperature	T <sub>J</sub>	150	°C
Storage temperature	T <sub>stg</sub>	-55 to +150	°C
Specified I/O frequencies	f	100	MHz

Transistors

●Electrical characteristics (Ta=25°C)

Tr

Parameter	Symbol	Min.	Typ.	Max.	Unit	Conditions
Collector-emitter breakdown voltage	BV <sub>CEO</sub>	-50	-	-	V	I <sub>c</sub> = -1mA
Collector-base breakdown voltage	BV <sub>CBO</sub>	-60	-	-	V	I <sub>c</sub> = -50μA
Emitter-base breakdown voltage	BV <sub>EB0</sub>	-6	-	-	V	I <sub>E</sub> = -50μA
Collector cutoff current	I <sub>cBO</sub>	-	-	-0.1	μA	V <sub>CB</sub> = -60V
Emitter cutoff current	I <sub>EBO</sub>	-	-	-0.1	μA	V <sub>EB</sub> = -5V
Collector-emitter saturation voltage	V <sub>CE(sat)</sub>	-	-	-0.5	V	I <sub>c</sub> /I <sub>B</sub> = -50mA/-5mA
DC current transfer ratio	h <sub>FE</sub>	120	-	560	-	V <sub>CE</sub> = -6V, I <sub>c</sub> = -1mA
Transition frequency	f <sub>r</sub>	-	140	-	MHz	V <sub>CE</sub> = -12V, I <sub>E</sub> = 2mA, f= 100MHz
Output capacitance	C <sub>ob</sub>	-	4	5	pF	V <sub>CB</sub> = -12V, I <sub>E</sub> = 0A, f= 1MHz

Di

Parameter	Symbol	Min.	Typ.	Max.	Unit	Conditions
Forward voltage	V <sub>F</sub>	-	-	1.2	V	I <sub>F</sub> =100mA
Reverse current	I <sub>R</sub>	-	-	0.1	μA	V <sub>R</sub> =70V
Capacitance between terminals	C <sub>T</sub>	-	-	3.5	pF	V <sub>R</sub> =6V, f=1MHz
Reverse recovery time	t <sub>rr</sub>	-	-	4	ns	V <sub>R</sub> =6V, I <sub>F</sub> =5mA, R <sub>L</sub> =50Ω

●Electrical characteristic curves

Tr

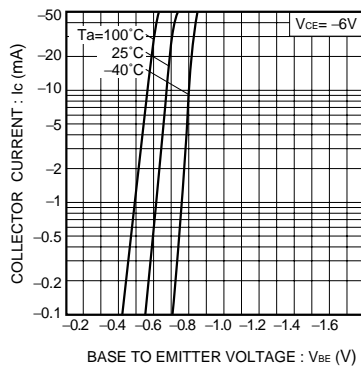

Fig.1 Grounded emitter propagation characteristics

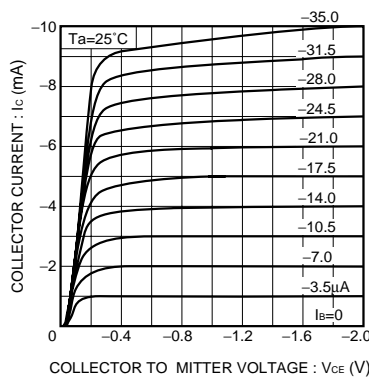

Fig.2 Grounded emitter output characteristics (I)

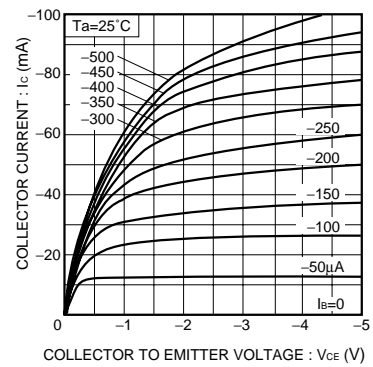

Fig.3 Grounded emitter output characteristics (II)

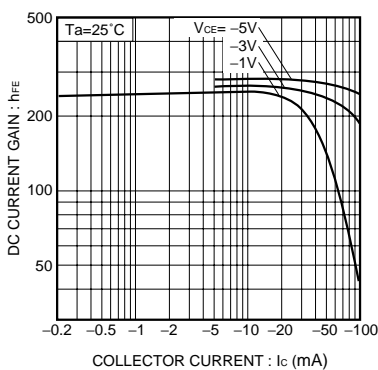

Fig.4 DC current gain vs. collector current (I)

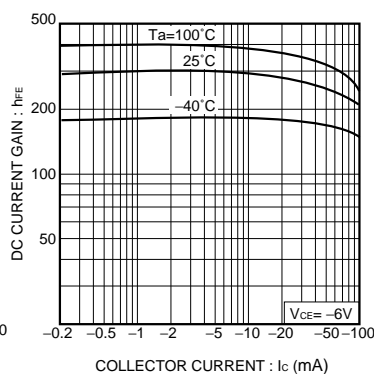

Fig.5 DC current gain vs. collector current (II)

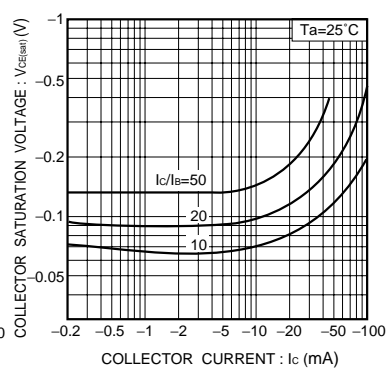

Fig.6 Collector-emitter saturation voltage vs. collector current (I)

Transistors

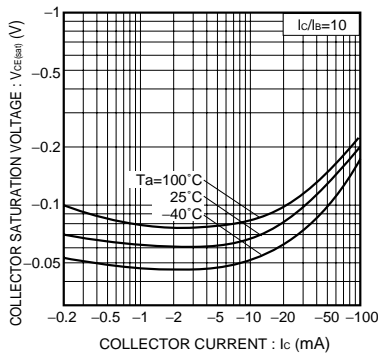

Fig.7 Collector-emitter saturation voltage vs. collector current (II)

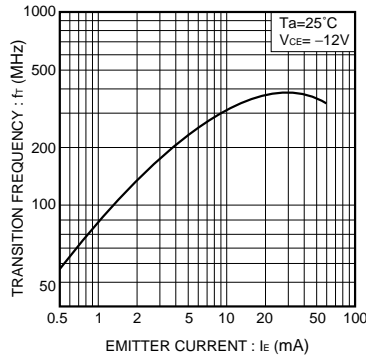

Fig.8 Gain bandwidth product vs. emitter current

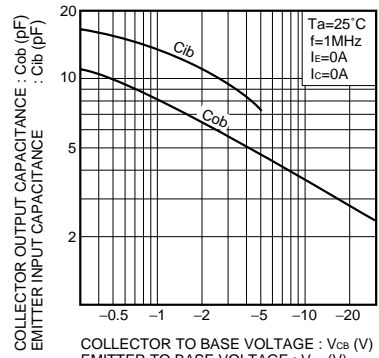

Fig.9 Collector output capacitance vs. collector-base voltage  
Emitter input capacitance vs. emitter-base voltage

Di

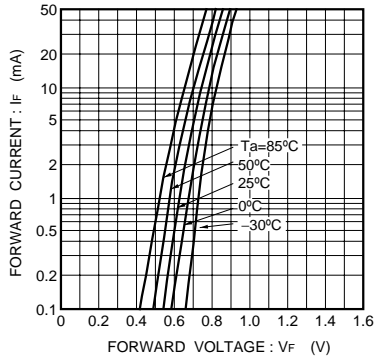

Fig.10 Forward characteristics

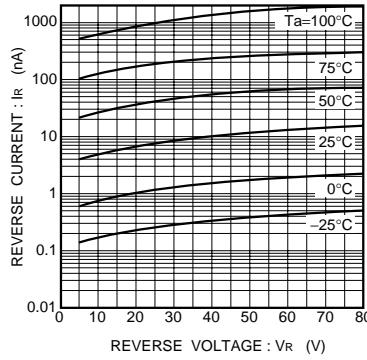

Fig.11 Reverse characteristics

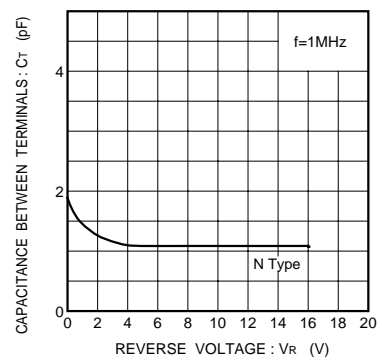

Fig.12 Capacitance between terminals characteristics

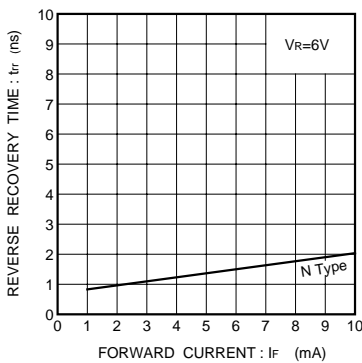

Fig.13 Reverse recovery time

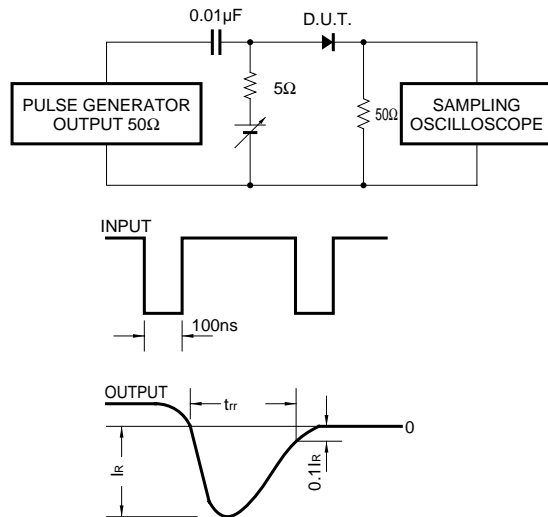

Fig.14 Reverse recovery time ( $t_{rr}$ ) measurement circuit

### Notes

- No technical content pages of this document may be reproduced in any form or transmitted by any means without prior permission of ROHM CO.,LTD.
- The contents described herein are subject to change without notice. The specifications for the product described in this document are for reference only. Upon actual use, therefore, please request that specifications to be separately delivered.
- Application circuit diagrams and circuit constants contained herein are shown as examples of standard use and operation. Please pay careful attention to the peripheral conditions when designing circuits and deciding upon circuit constants in the set.
- Any data, including, but not limited to application circuit diagrams information, described herein are intended only as illustrations of such devices and not as the specifications for such devices. ROHM CO.,LTD. disclaims any warranty that any use of such devices shall be free from infringement of any third party's intellectual property rights or other proprietary rights, and further, assumes no liability of whatsoever nature in the event of any such infringement, or arising from or connected with or related to the use of such devices.
- Upon the sale of any such devices, other than for buyer's right to use such devices itself, resell or otherwise dispose of the same, no express or implied right or license to practice or commercially exploit any intellectual property rights or other proprietary rights owned or controlled by
- ROHM CO., LTD. is granted to any such buyer.
- Products listed in this document are no antiradiation design.

The products listed in this document are designed to be used with ordinary electronic equipment or devices (such as audio visual equipment, office-automation equipment, communications devices, electrical appliances and electronic toys).

Should you intend to use these products with equipment or devices which require an extremely high level of reliability and the malfunction of which would directly endanger human life (such as medical instruments, transportation equipment, aerospace machinery, nuclear-reactor controllers, fuel controllers and other safety devices), please be sure to consult with our sales representative in advance.

#### About Export Control Order in Japan

Products described herein are the objects of controlled goods in Annex 1 (Item 16) of Export Trade Control Order in Japan.

In case of export from Japan, please confirm if it applies to "objective" criteria or an "informed" (by MITI clause) on the basis of "catch all controls for Non-Proliferation of Weapons of Mass Destruction.