

DATE CODE CAVITY ID

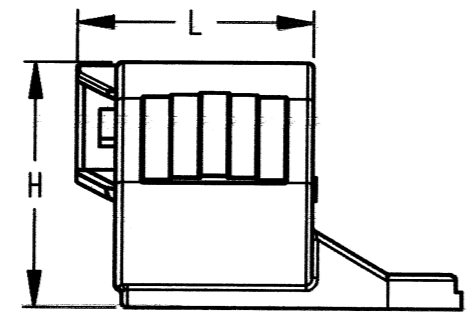

1011-349-1205

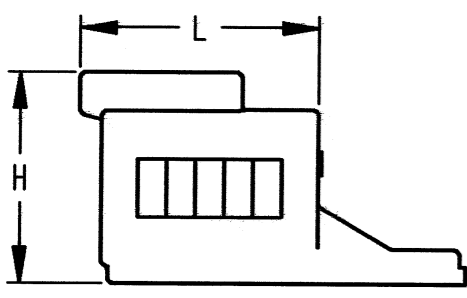
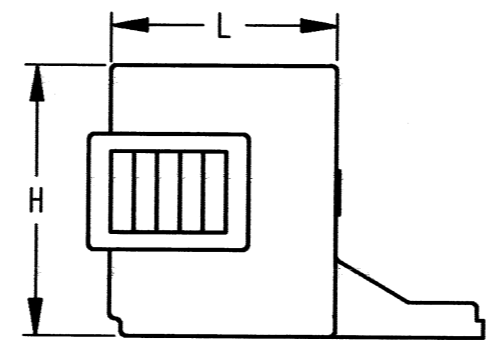
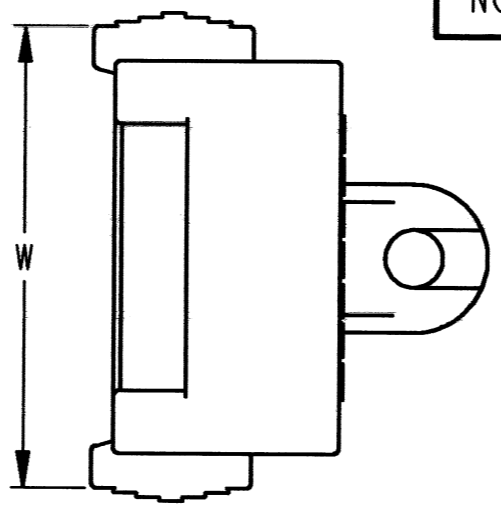
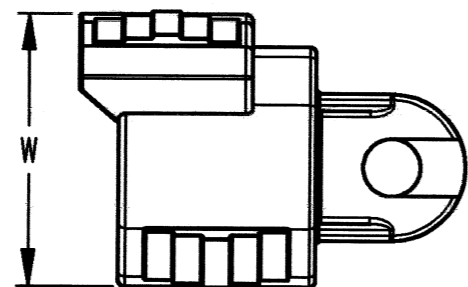
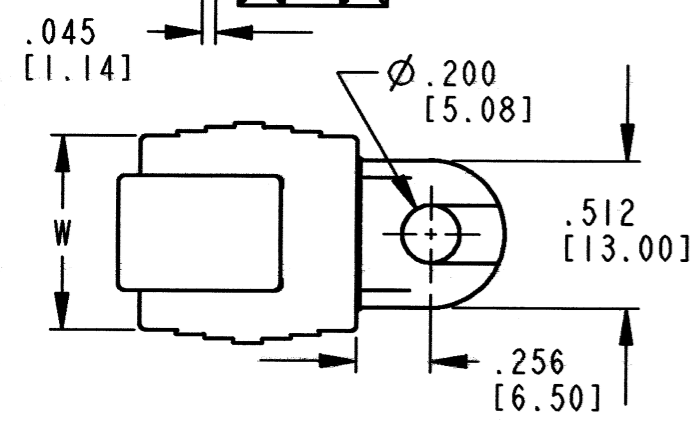
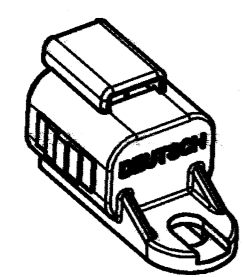

1011-344-0205

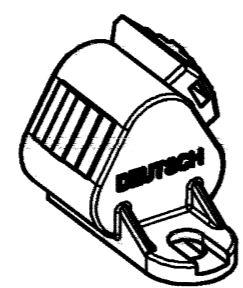

1011-345-0305

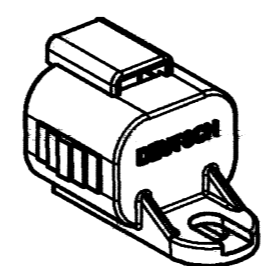

1011-346-0405

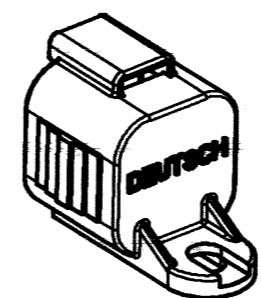

1011-347-0605

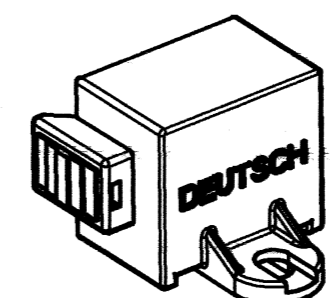

1011-348-0805

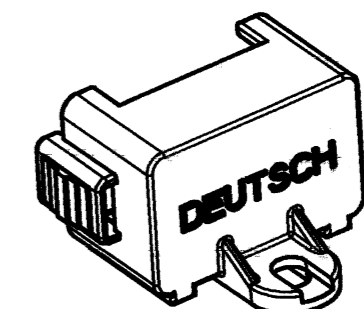

1011-349-1205

REV 344 THRU * *05
NC 349

REVISIONS			
SYM	DESCRIPTION	DATE	APPROVED
NC	NEW RELEASE PER E.O. P20538	7-9-10	ADR

CONNECTOR	ENVELOPE DIMENSIONS			PART NUMBER
	L	W	H	
DT06-2S	.830 [21.08]	.675 [17.15]	.730 [18.54]	1011-344-0205
DT06-3S	.820 [20.83]	.946 [24.02]	.848 [21.53]	1011-345-0305
DT06-4S	.830 [21.08]	.820 [20.83]	.836 [21.23]	1011-346-0405
DT06-6S	.830 [21.08]	.820 [20.83]	1.011 [25.68]	1011-347-0605
DT06-08S	.870 [22.10]	1.435 [36.45]	.960 [24.38]	1011-348-0805
DT06-12S DT16-15/18S	.830 [21.08]	1.597 [40.56]	.936 [23.77]	1011-349-1205

3. MATERIAL: PLASTIC; COLOR: BLACK
2. THESE PARTS MATE WITH DT PLUG CONNECTORS.
1. DIMENSIONS ARE IN INCHES [MILLIMETERS] AND ARE ±.025 [0.63] UNLESS OTHERWISE SPECIFIED.

NOTES:

SIGNATURE & DATE	
DR	R. MESSENGER 6/23/10
CHK	R. M... 7/9/10
PE	R. M... 7/12/10
APPD	S. B... 7-7-10
SCALE	NONE WT

2-12 WAY CAPS
FOR PLUGS

DT SERIES

ENVELOPE

EP	MATL. CODE
3850 INDUSTRIAL AVE. HEMET, CA 92545	
B	1011-344 THRU * *05 349
DWG SIZE	CODE 11139 SHEET OF