

APart

MASK SERIES

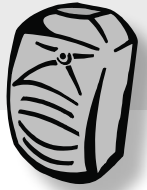

MANUAL



INFO@APART-AUDIO.COM



APART THANKS YOU

for purchasing loudspeakers of the MASK series.

Read this manual carefully to get the best result out of your music system.

MASK two way loudspeakers have been designed to fit in any interior and to be applicable in most situations.

The MASK supports shipped along, are a great tool for easy reliable installation and orientation.

Each model has a unique protection circuit which will only appear in the audio path when needed.

Three models are available: the MASK4 with a 4" driver; the MASK6 with a 6" driver and the wooden MASK8 with of course an 8" driver.

We're sure the MASK loudspeakers will give the finishing touch to your sound system.

Features

- Modern adaptive (double face) design (MASK 4 & 6)
- All models available in black or white (MASK4 also in silver)
- All MASKs are paintable
- Weather resistant (MASK 4 & 6)
- INTELLI-MOUNT snap-on system for safe and reliable mounting (MASK 4 & 6)
- Lockable rotating ball (MASK 4 & 6)
- Wall and ceiling mountable
- Unique overload protection
- Double protective grill (MASK 4 & 6)
- Asymmetric tweeter horn design for wider dispersion
- Great power handling
- Smooth sound

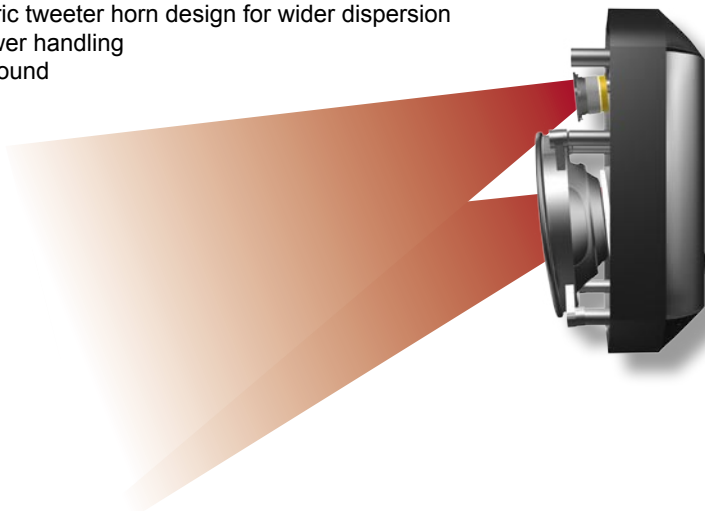

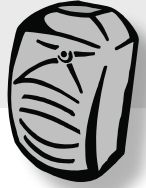

MASK4 Series

The most compact of the series uses a 4" LF driver and a dome tweeter on a Vari-throat horn. When you hear our junior, you'll be looking for a much bigger loudspeaker. All MASK4 models include a multi-tap 100V transformer. When you bypass this transformer you have a normal 16 ohms loudspeaker, which means you can easily use more than two MASK4, in parallel, on one normal amplifier channel.

Don't worry about the 16 Ω , MASK4T sounds as loud as other 8 Ω speakers !



MASK4TBL



MASK4TW



MASK4TSLV

MASK6 Series

Our mid-sized MASK is an extended-range full range loudspeaker fitted with a 6" LF driver and our smooth sounding dome tweeter on a Vari-throat horn. The sound will be projected over a wide coverage with a SPL which will surprise you.

The normal MASK6 is an 8 ohms model.

The MASK6T models include a multi-tap 100V transformer; when bypassed you have a 16 ohms loudspeaker.



MASK6BL
MASK6TBL



MASK6W
MASK6TW





Intelli-mount

This Intelligent mounting system will be your helpful partner to install your MASK 4 and 6 loudspeakers in a very safe and easy way.

Mounting and aiming your MASK will be done like a snap with your fingers.

- 1) First attach the base plate to the wall or ceiling, keeping in mind to which direction you will have to swing your MASK.
- 2) Fix the shaft/ball system to the snap on plate by means of the XXL nut.
- 3) Thread the assembled snap-on unit onto your MASK loudspeaker as far as it goes and tighten it firmly.
- 4) Adjust the MASK's to the desired position and fasten the XXL nut in such way, you can hardly move your MASK.
- 5) Hook into the Intelli-mount base plate.

Once hooked and aimed in the final direction you can fasten the XXL nut, so your MASK won't move ever again.

To secure the whole system, insert the security screw at the top and thread well.

When you mount your MASK to the ceiling, this screw must be inserted.

Minimum distance to ceiling/wall from the top of the base plate:

- MASK4 Intelli-mount : 45mm
- MASK6 Intelli-mount : 90mm

Make sure the mounting surface can support sufficient weight.

Use only industry-accepted materials and mounting methods.

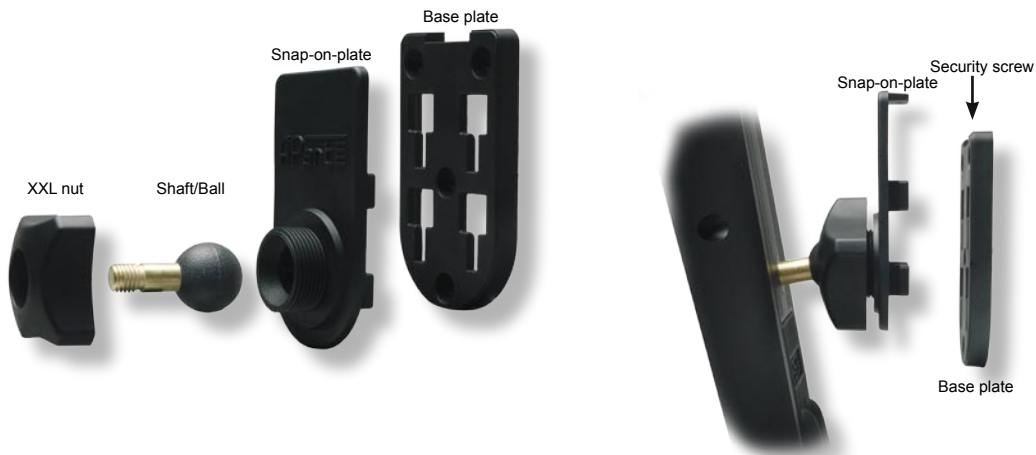

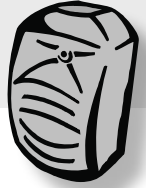

Connecting the speakers

Before hooking your MASK onto it's base, don't forget to set the proper voltage tap setting. To use your MASK4 with a normal (hifi) stereo amplifier you have to switch the voltage tap to 16 ohms. In this case you can easily connect 8 MASK4 to a stereo amplifier channel capable to drive a speaker load of 4 ohms.

Each doubling of the distance between the MASK and the listener results in a loss of 6 dB. With the example from above, at two meters, only 94dB are left when driving your loudspeaker with 10 watt and 88dB at 4 metres.

So you can calculate the necessary tap setting.

In a 100V setup you have to select one of the four 100V tapings (2,5 – 5 -10 or 20 watts). Each doubling of amplifier power fed to your loudspeaker, increases the SPL by 3dB. So, a loudspeaker which produces 100dB with 10 watt input at 1 meter, produces 103dB SPL at 1 m, when you feed him with 20 watts.

In 100V systems, the total selected power connected to the 100V amplifier should never pass the max. power of this amplifier.

To get good intelligibility, you need an SPL of about 10dB above the back-ground noise. Be sure to install sufficient loudspeakers and avoid death spots, so you don't have to pump up the volume too much.

The T-models of the MASK6 can be set to 16 ohm to use with stereol (hifi) amplifiers. For 100V systems the MASK6 has four 100V tapings (6 -15 -30 - 60 watts).

Benefits of 16Ω versus Benefits of 100Volt technology

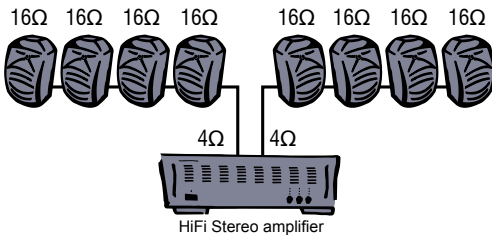

16Ω technology

- Dynamic High power
- Stereo HiFi quality
- Same volume in all zones
- Max 8 cabinets on a stereo HiFi amplifier

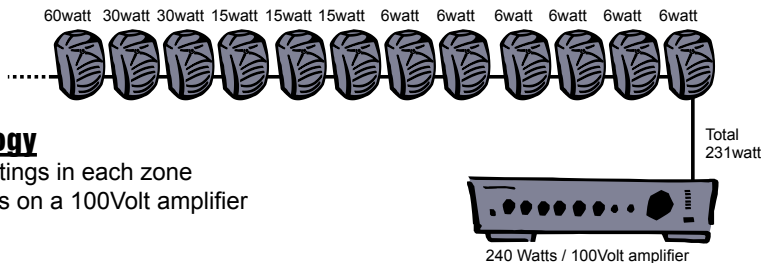

100 Volt technology

- Different volume settings in each zone
- More then 8 cabinets on a 100Vt amplifier
- Easy installation



Wiring

Connect the wires to the speaker at the back terminal plate observing the polarity of the connections. The push-terminals of the MASK6 accept banana connector plugs and wire by Push-Terminals.

To avoid confusion, use cables which have clear (colour) codes, so correct polarity can be maintained. Also use wires of the right gauge, certainly for longer distances.



Subwoofers

To improve reproduction of lower frequencies, it is advisable to add (powered) subwoofers to your sound system.

To calculate the number of subwoofers needed, determine the maximum rated output of a single subwoofer. Placing your subwoofer near one or more boundaries, increases the SPL by 3-6dB for each boundary (for certain frequencies).



SUB2400



SUB2200



SUB-A165

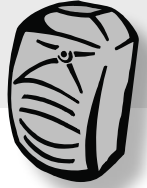

Overload Protection

All MASK models have a unique overload protection, which only comes into the signal path when needed. When too much power is fed into your MASK, first a red led will blink. When you neglect this warning, the overload protection will disconnect the signal going to the loudspeakers and the red led will remain on. Turn down the level and after about 5 seconds cooling down your favourite music will be heard again. When you don't want to work on your client's nerves, don't activate the overload protection !



Protection LED

Safety information

Important Safety Instructions

Before pushing your loudspeaker volumes to the edge, take a few minutes to read these instructions carefully. This little time might avoid claims afterwards.

1. Keep this manual for future reference.
2. Clean only with dry cloth.
3. Do not operate near heaters or place it on other apparatus which produce a lot of heat.
4. Take care for the speaker leads. Never use damaged leads and install them in such a way that no one can walk on it.
5. Only use accessories specified by the manufacturer.
6. Make sure the mounting surface can easily support the speaker's weight.
7. Use only industry-accepted rigging tools and methods.
8. Choose the right speaker for the right job.
9. Use sufficient loudspeakers and avoid death spots.
10. No main power shall be connected to the loudspeakers.
11. This apparatus should only be serviced by qualified personnel. If not, the warranty might be void.
12. Removal of the grill causes risk to loudspeaker damage.
13. Use cables of the right gauge, certainly for long runs.
14. Use cables with clear colour codes and maintain polarity throughout the whole system.
15. Switch amplifiers on with the volumes turned completely down to avoid loud clicks and clacks.
16. Avoid loud feedback for this is a main speaker killer!
17. Please check the units' condition after unpacking. If the outside of the carton box has been damaged, inform your shipper immediately.

Music colours our lives but too much sound might damage yours and other's hearing permanently!

Being exposed to loud sound levels over a long time can cause severe hearing loss. Don't forget to consult the local law directions regarding producing sound in public places. In some countries ear protection is obliged when the continuous sound level over 8 hours time is 80dB (A). Each halving of time allows an increase of 3dB.

Too weak amplifiers can burn your speakers

By pushing your amplifier or its inputs too much, your amp can produce more power than the power published in his manual. This power is not always clean and can be very distorted. When such signal is fed into your loudspeakers for a longer period, damage can be the result. Don't cut in the budget of your amplifier. A loudspeaker can demand to ten times the average power to reproduce those smashing sonic bursts you are kicking on. If your amplifier has enough reserve power, your sound will remain clear. When you squeeze your amp's throat, he'll be pushed to produce sounds which will kill your tweeters first.

Protection systems are not built to be activated all the time, they are there to warn you and to give you a safe margin!

APart

MASK SERIES

